

# CESAROM<sup>®</sup>

news 2024-2025



activează



**10** ani  
garanție

**ABS**  
Anti-slip Best  
Surface

**ABS**  
ANTI-SLIP BEST SURFACE



# Cuprins

## Contents

Brand	Colecție	Pag.
CESAROM®	ANNEX	166
CESAROM®	ARA	186
CESAROM®	ARGILA	224
CESAROM®	BEAUTY	168
<b>new</b>	CESAROM® BRECCIA	safe+ R ABS R10 16
	CESAROM® CALACATTA ORO	202
	CESAROM® CAMINO	118
	CESAROM® CANADA	120
	CESAROM® CARVING	204
<b>new</b>	CESAROM® CEMENTINO	safe+ R ABS R10 72
	CESAROM® CEPPO	168
<b>new</b>	CESAROM® CEPPO DI GRE	safe+ R ABS R10 22
	CESAROM® CITY	R 136
	CESAROM® COLORLINE	188
	CESAROM® CONCEPTO	138
	CESAROM® CONCRETE	146
	CESAROM® CREAM	122
	CESAROM® CREATIVO	190
	CESAROM® CROMATIC 3D	206
	CESAROM® CROMATIC GLOSS	192
	CESAROM® CRUST	safe+ R 84
	CESAROM® DECORA	170
	CESAROM® E-PROJECT	218
	CESAROM® ESSENTIAL	safe+ R 88
<b>new</b>	CESAROM® ETNA	safe+ R ABS R10 74
	CESAROM® FABRIC	220
<b>new</b>	CESAROM® FERRARA	148
	CESAROM® FIRENZE	150
	CESAROM® FLAKES	172
	CESAROM® FLAVOURS	208
	CESAROM® FRESH	210
	CESAROM® GARDEN	226
	CESAROM® GARDENA	172
	CESAROM® GRANITO	safe+ 128
	CESAROM® GRECIA	226
	CESAROM® KARO	174
	CESAROM® KING	174
<b>new</b>	CESAROM® LEGNO CLASSICO	safe+ R 76
<b>new</b>	CESAROM® LEGNO MIELE	safe+ R 78
	CESAROM® LIMESTONE	176
	CESAROM® LIVING	176
	CESAROM® LUBERON	safe+ 130
	CESAROM® LUX ARCTIC	R 56
	CESAROM® LUX CALACATTA GOLD	R 60
	CESAROM® LUX DYNO	R 62
	CESAROM® LUX MARBLE	R 64
	CESAROM® LUX MIRAGE	R 66
<b>new</b>	CESAROM® LUX NERO	R 38
	CESAROM® LUX ONIX	R 68
<b>new</b>	CESAROM® LUX PORTORO	R 70
<b>new</b>	CESAROM® LUX SPIDER	R 42
<b>new</b>	CESAROM® MAGMA	178
	CESAROM® MAIOLICA	222
	CESAROM® MARINA	212
	CESAROM® MAYENNE	180
	CESAROM® MIRAGE	152
	CESAROM® MOVE	safe+ R 92
	CESAROM® NALIM	196
	CESAROM® NATURA	180
	CESAROM® NORDIC WOOD	214
	CESAROM® NORWAY	182
<b>new</b>	CESAROM® PAVIMENTO	safe+ R 80
	CESAROM® PERFECT	154
	CESAROM® PIEDRA	safe+ R R11 96
<b>new</b>	CESAROM® PULPIS	156

Brand	Colecție	Pag.
CESAROM®	PURITY	158
CESAROM®	QUARTZ	safe+ R R11 98
CESAROM®	QUARTZITE	228
CESAROM®	RIVER STONES	132
<b>new</b>	CESAROM® ROVERE	safe+ R 50
	CESAROM® STATUARIO	100
	CESAROM® STRIPES	200
	CESAROM® TANUM	safe+ R R10 106
	CESAROM® TERRA	182
	CESAROM® TERRAZZINO	safe+ 134
	CESAROM® TERRAZZO	106
<b>new</b>	CESAROM® THERME	safe+ R R11 28
	CESAROM® TRAVER	safe+ R 110
	CESAROM® TRAVERTINE	216
	CESAROM® TRENDY	R 142
	CESAROM® UNIQUE	160
	CESAROM® VENICE	R 144
	CESAROM® WHITE PROJECT	164
	CESAROM® WRIGHT	safe+ 114
	CESAROM® YARD	184

## RAKO Home

RAKO®	ALBA	R 316
RAKO®	BASE	R 310
RAKO®	BETONICO	R ABS 262
<b>new</b>	RAKO® BETONICO OUTDOOR	R R11 274
	RAKO® BOA	R 314
	RAKO® BOARD	R 326
<b>new</b>	RAKO® BRICOLA	R ABS 248
<b>new</b>	RAKO® BRICOLA OUTDOOR	R ABS R11 254
<b>new</b>	RAKO® CASTONE	R ABS 232
<b>new</b>	RAKO® CASTONE OUTDOOR	R R11 238
	RAKO® CAVA	R 300
	RAKO® CEMENTO	R 290
	RAKO® EXTRA	R ABS 276
	RAKO® FARO	R 330
	RAKO® NEXT	R 334
	RAKO® ONYX	R 301
	RAKO® PIAZZETTA OUTDOOR	R R11 298
<b>new</b>	RAKO® PLYWOOD	R ABS 256
	RAKO® PORFIDO	R ABS 292
	RAKO® QUARZIT	R 302
	RAKO® QUARZIT OUTDOOR	R R11 306
	RAKO® RANDOM	R 308
	RAKO® REBEL	R 284
	RAKO® SALOON	R 322
	RAKO® STONES	R 320
	RAKO® UP	R 332
<b>new</b>	RAKO® VALS	R ABS 240
<b>new</b>	RAKO® VALS OUTDOOR	R R11 246

## RAKO Object

<b>new</b>	RAKO® COMPILA	R ABS 340
	RAKO® COLOR ONE	402
	RAKO® COLOR TWO	R 416
	RAKO® KAAMOS	R 364
	RAKO® KAAMOS OUTDOOR	R R11 364
	RAKO® TAURUS COLOR	R ABS 388
	RAKO® TAURUS GRANIT	R ABS 366
	RAKO® TAURUS INDUSTRIAL	R ABS 382



120x40  
 COLOR ONE.....404



90x30  
 BASE.....311  
 BOA.....315  
 COLOR ONE.....404  
 CONCEPTO.....140

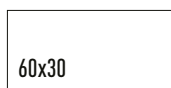

60x30  
 BASE.....311  
 CITY.....137  
 COLOR ONE.....405  
 CONCEPTO.....141  
 CONCRETE.....147  
 CREAM.....125  
 FERRARA.....149  
 FIRENZE.....151  
 MIRAGE.....153  
 NEXT.....335  
 PERFECT.....155  
 PULPIS.....157  
 PURITY.....159  
 TANUM.....108  
 THERME.....37  
 TRENDY.....143  
 UNIQUE GLOSSY.....161  
 UNIQUE MAT.....163  
 UP.....333  
 VENICE.....145  
 WHITE PROJECT.....165



60x20  
 COLOR ONE.....406



50x25  
 ARA.....187  
 COLORLINE.....189  
 CREATIVO.....191  
 CROMATIC GLOSS.....193  
 NALIM.....199  
 STATUARIO.....103  
 STRIPES.....201  
 WHITE PROJECT.....165

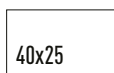

40x25  
 CALACATTAORO.....203  
 CARVING.....205  
 CROMATIC 3D.....207  
 FLAVOURS.....209  
 FRESH.....211  
 MARINA.....213  
 NORDIC WOOD.....215  
 TRAVERTINE.....217  
 WHITE PROJECT.....165

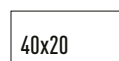

40x20  
 COLOR ONE.....407  
 E-PROJECT.....219  
 FABRIC.....221  
 MAIOLICA.....223  
 WHITE PROJECT.....165



30x30

BASE.....311  
 NEXT.....335  
 TRENDY.....143  
 UP.....333  
 VENICE.....145



30x29

STATUARIO.....103



25x33  
 COLOR ONE.....407



20x25  
 COLOR ONE.....408



20x20  
 COLOR ONE.....408



20x15  
 COLOR ONE.....408



15x15  
 COLOR ONE.....409

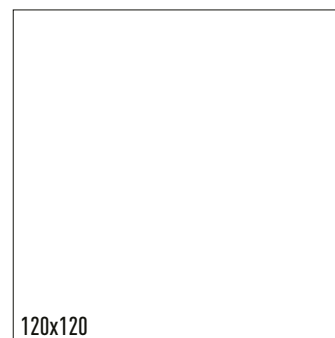

120x120  
 BETONICO.....264



120x60  
 ALBA.....318  
 BETONICO.....266  
 BRECCIA.....18  
 BRICOLA.....250  
 CEPPO DI GRE.....24  
 COMPILA.....354  
 EXTRA.....278  
 LUX ARCTIC.....57  
 LUX CALACATTA GOLD.....61  
 LUX DYNO.....63  
 LUX MARBLE.....65  
 LUX MIRAGE.....67  
 LUX NERO.....41  
 LUX ONIX.....69  
 LUX PORTORO.....71  
 LUX SPIDER.....46  
 PLYWOOD.....258  
 PORFIDO.....294  
 REBEL.....286  
 THERME.....32  
 VALS.....242



120x30  
 BOARD.....328  
 SALOON.....324

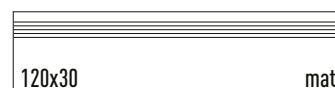

120x30 mat  
 ALBA.....318  
 BETONICO.....267  
 BOARD.....329  
 BRECCIA.....18  
 BRICOLA.....253  
 CEPPO DI GRE.....24  
 COMPILA.....355  
 EXTRA.....283  
 LUX SPIDER.....46  
 PLYWOOD.....261  
 PORFIDO.....297  
 REBEL.....287  
 SALOON.....324  
 THERME.....32  
 VALS.....245

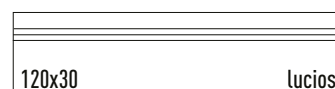

120x30 lucios  
 LUX ARCTIC.....57  
 LUX CALACATTA GOLD.....61  
 LUX DYNO.....63  
 LUX MARBLE.....65  
 LUX MIRAGE.....67  
 LUX NERO.....41  
 LUX ONIX.....69  
 LUX PORTORO.....71  
 LUX SPIDER.....47

120x20

BOARD.....	328
BRICOLA.....	250
PLYWOOD.....	259
ROVERE.....	54
SALOON.....	324

80x80

BETONICO.....	270
CASTONE.....	233
EXTRA.....	280
QUARZIT.....	304
REBEL.....	288

80x20

SALOON.....	324
-------------	-----

60x60

BASE.....	313
BETONICO.....	268
BRECCIA.....	19
CASTONE.....	235
CAVA.....	300
CEPPO DI GRE.....	25
CEMENTO.....	291
COMPILA.....	354
EXTRA.....	282
KAAMOS.....	365
LUX NERO.....	40
LUX SPIDER.....	49
ONYX.....	301
PORFIDO.....	296
RANDOM.....	309
REBEL.....	289
STONES.....	321
THERME.....	33
VALS.....	243
TAURUS COLOR UGL.....	391
TAURUS GRANIT UGL.....	368

60x60

**OUTDOOR**

BETONICO OUTDOOR.....	275
BRICOLA OUTDOOR.....	255
CASTONE OUTDOOR.....	239
KAAMOS OUTDOOR UGL.....	365
PIAZZETTA OUTDOOR UGL.....	299
QUARZIT OUTDOOR UGL.....	307
VALS OUTDOOR.....	247

60x60

CASTONE.....	237
VALS.....	245

60x30

BRECCIA.....	21
CAMINO.....	119
CANADA.....	121

COLOR TWO.....	418
CEMENTINO.....	73
CEPPO DI GRE.....	27
COMPILA.....	354
CREAM.....	127
CRUST.....	87
ESSENTIAL.....	91
ETNA.....	75
GRANITO.....	129
LEGNO CLASSICO.....	77
LUBERON.....	131
MOVE.....	95
PIEDRA.....	97
QUARTZ.....	99
RIVER STONES.....	133
ROVERE.....	55
STATUARIO.....	105
TANUM.....	109
TAURUS COLOR UGL.....	391
TAURUS GRANIT UGL.....	368
TERRAZZINO.....	135
TERRAZZO.....	109
THERME.....	34
TRAYER.....	113
WRIGHT.....	117

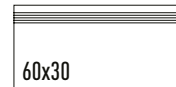

BASE.....	313
BETONICO.....	273
BRECCIA.....	21
CEMENTO.....	291
CEMENTINO.....	73
CEPPO DI GRE.....	27
COMPILA.....	355
CRUST.....	87
ETNA.....	75
EXTRA.....	283
KAAMOS.....	365
GRANITO.....	129
LUBERON.....	131
LUXNERO.....	40
LUXSPIDER.....	49
PIEDRA.....	97
PORFIDO.....	297
QUARTZ.....	99
REBEL.....	289
STATUARIO.....	105
TANUM.....	109
THERME.....	34
TRAYER.....	113
TAURUS COLOR UGL.....	392
TAURUS GRANIT UGL.....	370

60x15

FARO.....	331
LEGNO CLASSICO.....	77
LEGNO MIELE.....	79
PAVIMENTO.....	82
ROVERE.....	55
VALS.....	243

60x10

VALS.....	243
-----------	-----

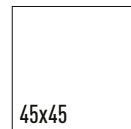

ANNEX.....	167
BEAUTY.....	169
CALACATTA ORO.....	203
CEPPO.....	169
COMPILA.....	354
CONCRETE.....	147
CREAM.....	125
CREATIVO.....	191
CRUST.....	87
DECORA.....	171
FERRARA.....	149
FIRENZE.....	151
FLAKES.....	173
GARDENA.....	173
KARO.....	175
KING.....	175
LIMESTONE.....	177
LIVING.....	177
MAGMA.....	179

MAYENNE.....	181
MIRAGE.....	153
NALIM.....	199
NATURA.....	181
NORDIC WOOD.....	215
NORWAY.....	183
PERFECT.....	155
PULPIS.....	157
PURITY.....	159
STATUARIO.....	103
TERRA.....	183
TRAVERTINE.....	217
YARD.....	185



ARA.....	187
ARGILA.....	225
COLORLINE.....	189
DECORA.....	171
FABRIC.....	221
GARDEN.....	227
GRANITO.....	129
GRECIA.....	227
QUARTZITE.....	229
ROMANTICA.....	207,211
STRIPES.....	201
TANUM.....	109



COLOR TWO.....	418
COMPILA.....	354
TAURUS COLOR UGL.....	391
TAURUS GRANIT UGL.....	368
TAURUS INDUSTRIAL UGL.....	384

30x10

COMPILA.....	363
COLOR TWO.....	418



30x30

BETONICO.....	272
BOARD.....	328
BRICOLA.....	251
CASTONE.....	237
CAVA.....	300
CEMENTO.....	291
COLOR TWO.....	419
COMPILA.....	355
CRUST.....	87
ESSENTIAL.....	91
FARO.....	331
KAAMOS.....	365
LEGNO MIELE.....	79
MOVE.....	95
ONYX.....	301
PAVIMENTO.....	82
PIEDRA.....	97
PORFIDO.....	297
QUARTZ.....	99
QUARZIT.....	304
RANDOM.....	309
ROVERE.....	55
SALOON.....	324
STATUARIO.....	105
STONES.....	321
TANUM.....	109
TAURUS GRANIT UGL.....	369
TAURUSCOLORUGL.....	391
VALS.....	245
WRIGHT.....	117



COLOR TWO.....	418
TAURUS COLOR UGL.....	391
TAURUS GRANIT UGL.....	369
TAURUS INDUSTRIAL UGL.....	384

20x10

COLOR TWO.....	418
----------------	-----

Stresantă renovarea?

**SCHIMBĂ**

**PLACA CU**

**CESAROM<sup>®</sup>**

și câștigi de 2X!\*

\*REGULAMENT DISPONIBIL PE CESAROM.RO



activează



**10** ani garanție

și manopera  
înapoi.



## ABS surface

The surface of the tiles with ABS marking is smooth, very pleasant to the touch, with R10/B anti-slip guarantee. It also meets the requirement for excellent cleanability and chemical resistance and is suitable for highly exposed floors.

With the ABS surface, RAKO has set a new standard in quality, functionality and cleanability for glazed and unglazed tiles.





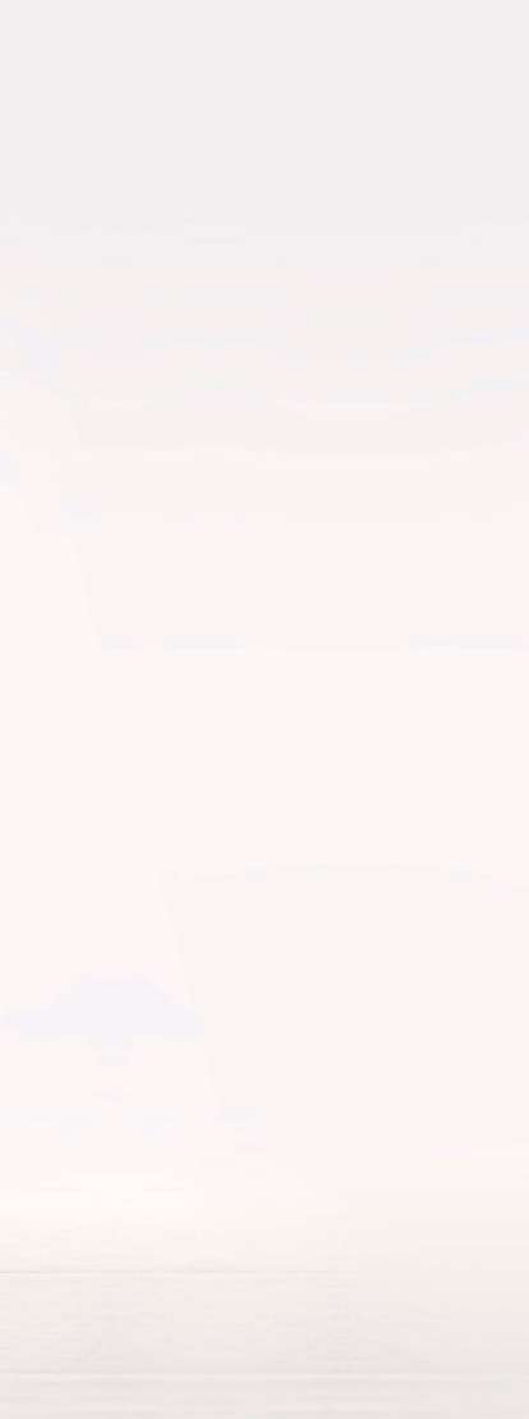

## suprafață ABS

Suprafața plăcilor marcate cu ABS este netedă, foarte plăcută la atingere, cu garanție anti-alunecare R10/B. De asemenea, îndeplinește cerințele pentru o curățare excelentă și rezistență chimică și este potrivită pentru pardoseli exterioare expuse la condiții foarte severe.

Cu suprafața ABS, RAKO a stabilit un nou standard în ceea ce privește calitatea, funcționalitatea și ușurința de curățare pentru plăcile glazurate și neglazurate.



# CESAROM®

safe+. Acum și cu ABS.  
10 ani garanție.

Gresia porțelanată rectificată CESAROM® safe+ cu suprafață anti-bacteriană din 2024 are și suprafață cu tehnologie ABS. (Anti-slip Best Surface).

Nova suprafață ABS garantează valori anti-alunecare de top R10 sau R11. Se curăță fără efort. În plus oferă senzație foarte plăcută la atingere. 7 beneficii unice prin care CESAROM® safe+ ABS stabilește un nou punct de referință în calitate, funcționalitate, protecție anti-bacteriană și ușurință în întreținere.

De aceea CESAROM® oferă 10 ani garanție. Vizitează [www.cesarom.ro](http://www.cesarom.ro) scanând codul QR și află detaliile campaniei 2024.

CESAROM®

Plăci ceramice fabricate în vest.

La Cluj. Din 1962.





**MATT NO-reflex**

**SOFT touch** 

**Easy To CLEAN**

**Anti-Alunecare**  
 **R 10**

A red rectangular sticker with white text and a QR code. The text includes 'activează' at the top, '10 ani' in large font, and 'garanție' below it. The QR code is in the center.

**activează**  
**10 ani**  
**garanție**

**safe+**<sup>™</sup>



**99,99%**  
PROTECȚIE  
ANTIBACTERIANĂ

# CESAROM®

NOUA gamă

CESAROM® **safe+**<sup>TM</sup>

gresie porțelanată cu protecție

**ANTIBACTERIANĂ** pe viață.

# safe+™



Nanoparticulele de argint încorporate în glazura plăcilor de gresie porțelanată **CESAROM® safe+™** elimină activ **99,99%** din bacterii și microbi, inhibă dezvoltarea mușgaiului și răspândirea bacteriilor / Silver nanoparticles in the glaze of **CESAROM® safe+™** tiles destroy **99.99%** of bacteria and microbes, inhibiting mold growth and bacterial multiplication.



**Protecția ANTIBACTERIANĂ** înglobată în noua gamă **CESAROM® safe+™** este **PERMANENTĂ** și nu afectează calitatea și nuanța plăcilor / The **ANTIBACTERIAL** protection included in the new **CESAROM® safe+™** range is **PERMANENT** and has no effect on the tile's quality or color.



**Protecția ANTIBACTERIANĂ** **CESAROM® safe+™** nu necesită activare cu dispozitive UV ca în cazul altor produse de pe piață / **CESAROM® safe+™** **ANTIBACTERIAL** protection does not require any activation with UV devices as other products on the market.

Nanoparticulele de argint măresc proprietățile igienice și prospețimea spațiului indiferent de prezența razelor UV sau de perioada zilei / Silver nanoparticles increase the hygienic properties and freshness of the space regardless of the presence of UV rays or the time of day.



**Protecția ANTIBACTERIANĂ** este garantată pe toată durata de viață a plăcilor **CESAROM® safe+™**, atât la interior, cât și la exterior indiferent de anotimp sau condiții meteo / **CESAROM® safe+™** tiles provide permanent **ANTIBACTERIAL** protection throughout their lifetime, both indoors and outdoors, - in any season or weather condition.



**MEDIU MAI CURAT & COSTURI de ÎNTREȚINERE MAI MICI** / **CLEANER ENVIRONMENT AND LOWER MAINTENANCE COSTS.**

Nanoparticulele de argint distrug ciclul de viață al bacteriilor. Astfel, suprafețele placate cu noua gamă **CESAROM® safe+™** au costul de întreținere și curățare mult mai redus. Oferă aer proaspăt fără mirosuri neplăcute, un mediu mai puțin poluat prin reducerea consumului de agenți chimici agresivi de curățare / Silver nanoparticles destroy bacteria, thus, surfaces coated with the new **CESAROM® safe+™** range provide fresh air, free of unpleasant odors, a less polluted environment by reducing the use of aggressive chemical cleaning agents, and lower the maintenance and cleaning costs.



**CESAROM® safe+™ & CEMIX® SilverCol**

**SOLUȚIE ANTIBACTERIANĂ COMPLETĂ** / **CESAROM® safe+™ & CEMIX® SilverCol** are **COMPLETE ANTIBACTERIAL SOLUTIONS**

Pentru protecție ANTIBACTERIANĂ completă recomandăm rostuirea gresiei porțelane din gama **CESAROM® safe+™** utilizând chitul de rosturi **CEMIX® SilverCol** cu aceleași proprietăți antibacteriene / We recommend jointing the **CESAROM® safe+™** tile range using the **CEMIX® SilverCol** joint grout, with the same antibacterial properties.

**SOLUȚIE ANTIBACTERIANĂ CERTIFICATĂ** / **CERTIFIED ANTIBACTERIAL SOLUTION**

Noua gamă **CESAROM® safe+™** este certificată în laboratoarele germane **QualityLabs BT GmbH** conform standardului internațional **ISO 22916**. / The new **CESAROM® safe+™** range has been certified by the German **QualityLabs BT GmbH** in accordance with **ISO 22916**.



CertIFICATELE **CESAROM® safe+™** le puteți consulta pe [www.cesarom.ro/safeplus](http://www.cesarom.ro/safeplus) / You can find **CESAROM® safe+™** certificate on [www.cesarom.ro/safeplus](http://www.cesarom.ro/safeplus)

# CESAROM®

## Ce este CESAROM® safe+™ și cum funcționează ? What is CESAROM® safe+™ and how does it work ?

Capacitatea nanoparticulelor de argint de a distruge microorganismele infecțioase face din argint unul dintre cei mai puternici agenți antimicrobieni. Nanoparticulele de argint eliberate pe suprafețe distrug proteinele agenților patogeni.

The ability of silver nanoparticles to destroy contaminating microorganisms makes silver one of the most powerful antimicrobial agents. Silver nanoparticles released on surfaces destroy the proteins of pathogens.

Gresia porțelanată CESAROM® safe+™ este tratată ireversibil cu o dispersie coloidală de nanoparticule de argint (AgNP), protecție înglobată în structura plăcilor înainte de ardere / CESAROM® safe+™ tiles are irreversibly treated with a colloidal dispersion of silver nanoparticles (AgNP), protection embedded in the structure of the tiles before firing.

Prin arderea plăcilor CESAROM® safe+™ la 1200 C° se creează o barieră bacteriostatică, igienică, intrinsecă ce nu se degradează în timp / By burning the CESAROM® safe+™ plates at 1200 C, a bacteriostatic, hygienic, intrinsic barrier is created, which does not deteriorate over time

Nanoparticulele de argint rămân înglobate în plăci, inhibând proliferarea bacteriilor și a altor microorganisme / The silver nanoparticles remain embedded in the tiles, inhibiting the proliferation of bacteria and other microorganisms.

Aplicația de nanoparticule Ag nu este toxică, ea fiind obținută printr-o sinteză chimică verde, prietenoasă mediului / The application of Ag nanoparticles is non-toxic, it is obtained through a green, environmentally friendly chemical synthesis.

Testarea eșantioanelor de gresie porțelanată CESAROM® safe+™ a fost realizată în laboratoarele germane QualityLabs BT GmbH în conformitate cu ISO 22916 / The testing of CESAROM® safe+™ tile samples was carried out in the QualityLabs BT GmbH laboratories in accordance with ISO 22916.

În teste s-au folosit eșantioane de plăci CESAROM® netratate și eșantioane de plăci CESAROM® safe+™ tratate cu nanoparticule de Ag / Untreated CESAROM® tile samples and CESAROM® safe+™ tile samples treated with Ag nanoparticles were used in the tests

Evoluția activității bacteriene pe suprafața netratată / Evolution of bacterial activity on untreated area:

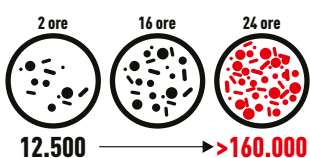

După 24 de ore microbii și bacteriile s-au înmulțit de la 12.500 la 160.000 / After 24 hours microbes and bacteria multiply from 12,500 to 160,000.

Evoluția activității bacteriene pe suprafața CESAROM® safe+™ / Evolution of bacterial activity on a CESAROM® safe+™ area:

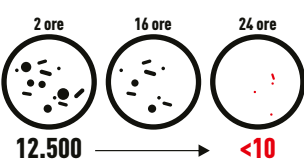

După maxim 24 de ore microbii și bacteriile s-au redus în proporție de 99,99% pe gresia porțelanată CESAROM® safe+™ de la 12.500 la mai puțin de 10

/ After a maximum of 24 hours, microbes and bacteria are reduced by 99.99% on CESAROM® safe+™ tiles from 12,500 to less than 10



## DESTINAȚII CESAROM® safe+™ / CESAROM® safe+™ DESTINATIONS

- REZIDENȚIAL / REZIDENȚIAL
- HOTELURI / HOTELS  
RESTAURANTE / RESTAURANTS
- ȘCOLI, GRĂDINIȚE / SCHOOLS, KINDERGARTENS
- CABINETE MEDICALE / MEDICAL OFFICE  
LABORATOARE / LABORATORIES
- BIROURI / OFFICES  
INSTITUȚII PUBLICE / PUBLIC INSTITUTIONS
- SPA, PISCINE / WELLNESS  
SĂLI DE FITNESS / FITNESS CENTERS
- SPAȚII COMERCIALE / COMMERCIAL CENTERS
- TOALETE PUBLICE / PUBLIC TOILETS

Lista cu produsele din gama CESAROM® safe+™ o puteți consulta pe [www.cesarom.ro](http://www.cesarom.ro) / The list of products in the CESAROM® safe+™ range are available on [www.cesarom.ro](http://www.cesarom.ro)

Căutați produsele cu eticheta în ambalaje CESAROM® safe+™

Search in CESAROM® stores and partner stores for products labeled in CESAROM® safe+™ packaging.



# news 2024-2025

120 x 60



120 x 30



120 x 20



60 X 60





60 x 30



60 x 30



60 x 15



30 x 30



activează



10 ani garanție

și manopera înapoi.

new

# Breccia



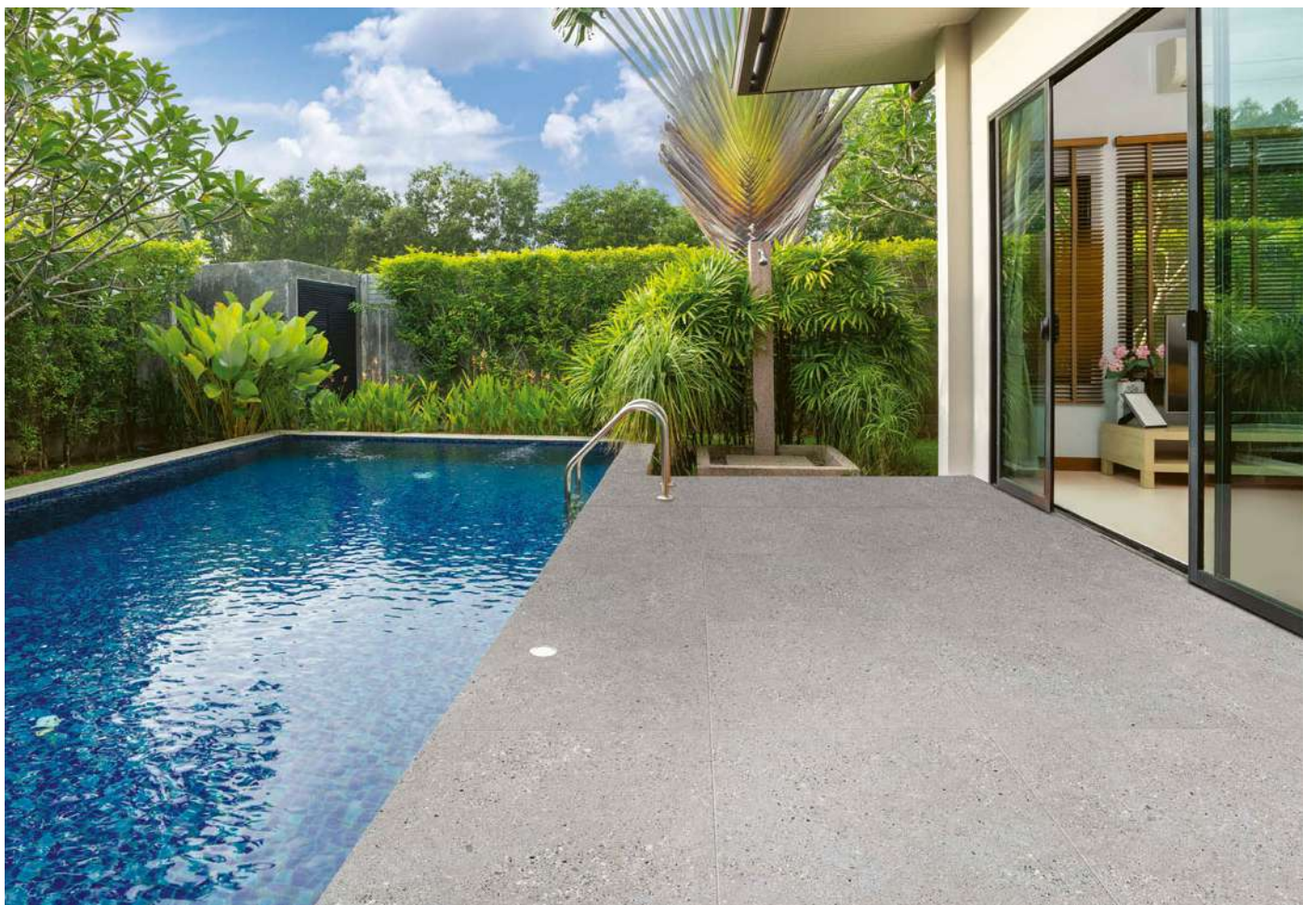

120 x 60



6493-0077 ivoriu/ivory | mat/matt PEI 5



6493-0076 bej/beige | mat/matt PEI 4



6493-0075 gri/grey | mat/matt PEI 4

120 x 30

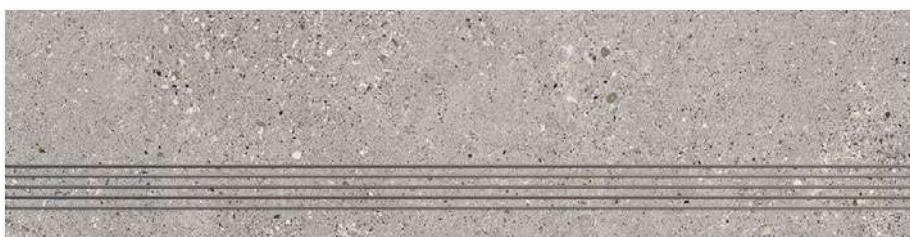

6895-0048 gri/grey | mat/matt PEI 4

6895-0050 ivoriu/ivory | mat/matt PEI 5

6895-0049 bej/beige | mat/matt PEI 4

**activează**



**10** ani garanție

și manopera înapoi.

**6461-0326** ivoriu/ivory | mat/matt PEI 5

**6461-0325** bej/beige | mat/matt PEI 4

**6461-0324** gri/grey | mat/matt PEI 4

60 x 60



V3



R10|B

Produs / Product



Produs / Product	cm	EN	Box	m <sup>2</sup>	Box	m <sup>2</sup>	kg	brutto kg
Gresie porțelanată rectificată / Rectified porcelain tile	120 x 60 x 0,9	EN 14411:2012, Annex G, Bla GL	2	1,44	27/30	38,88/43,2	30	831/921
Treaptă / Stair	120 x 30 x 0,9	EN 14411:2012, Annex G, Bla GL	3	1,08				
Gresie porțelanată rectificată / Rectified porcelain tile	60 x 60 x 0,9	EN 14411:2012, Annex G, Bla GL	4	1,44	32	46,08	27,6	908

**RECOMANDARE / RECOMMENDATION**

 Înainte de a monta plăcile, vă sugerăm să selectați din mai multe cutii, să amestecați plăcile (inclusiv prin rotirea lor cu 180°) și să le aranjați așa cum este ilustrat în fotografia de inspirație sau să consultați site-ul [www.cesarom.ro](http://www.cesarom.ro).

 Before laying the tiles, we suggest you select from several boxes and arrange them as illustrated in the inspiration photo above or consult the [www.cesarom.ro](http://www.cesarom.ro) website and mix the tiles to achieve the required result including turning them by 180°.



# Breccia



**RECOMANDARE / RECOMMENDATION**

Înainte de a monta plăcile, vă sugerăm să selectați din mai multe cutii, să amestecați plăcile (inclusiv prin rotirea lor cu 180°) și să le aranjați așa cum este ilustrat în fotografia de inspirație sau să consultați site-ul [www.cesarom.ro](http://www.cesarom.ro).

Before laying the tiles, we suggest you select from several boxes and arrange them as illustrated in the inspiration photo above or consult the [www.cesarom.ro](http://www.cesarom.ro) website and mix the tiles to achieve the required result including turning them by 180°.

Produs / Product	cm	EN		m <sup>2</sup>		m <sup>2</sup>	kg	brutto kg
Gresie porțelanată rectificată / Rectified porcelain tile	60 x 30 x 0,9	EN 14411:2012, Annex G, Bla GL	7	1,26	40	50,40	23,6	960
Treaptă / Stair	60 x 30 x 0,9	EN 14411:2012, Annex G, Bla GL	6	1,08				

safe+  
99,9%  
ANTIBACTERIAN  
PROTECȚIE

SOFT  
Touch

MATT  
NO Reflex

ABS  
Anti-slip Best  
Surface



CESAROM®



60 x 30



6460-0298  
maro/brown | mat/matt PEI 4

6460-0297  
gri/gray | mat/matt PEI 4

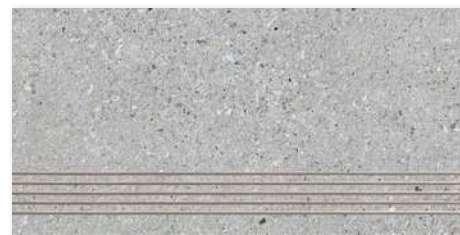

6806-0056  
maro/brown | mat/matt PEI 4

6806-0060  
gri/gray | mat/matt PEI 4

60 x 30



new

## Ceppo di Gre







# Ceppo di Gre



120 x 60



**6493-0081**  
gri/grey mat/matt PEI 4

120 x 30

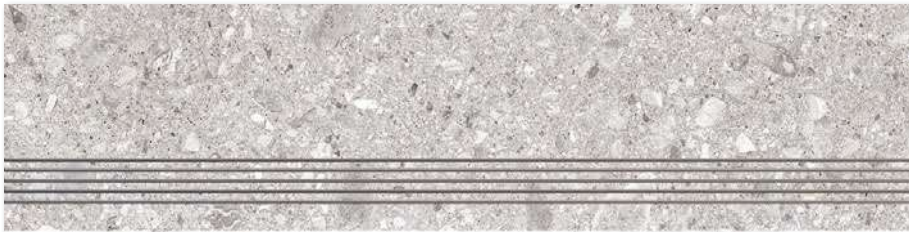

**6895-0054**  
gri/grey | mat/matt PEI 4

120 x 60



**6493-0082**  
bej/beige | mat/matt PEI 5

120 x 60



**6895-0055**  
bej/beige | mat/matt PEI 5



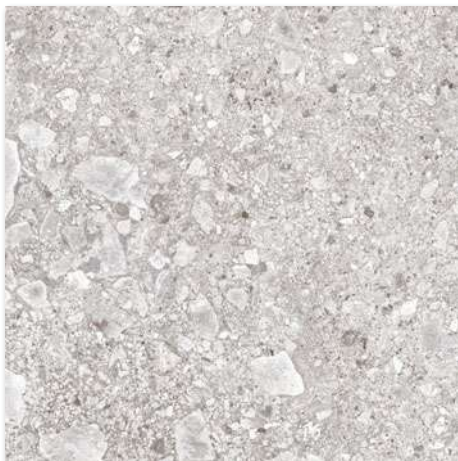

60 x 60



V3



R10|B

**6461-0333**  
 gri/gray | mat/matt PEI 4

**6461-0334**  
 bej/beige | mat/matt PEI 5

Produs / Product								
Gresie porțelanată rectificată / Rectified porcelain tile	120 x 60 x 0,9	EN 14411:2012, Annex G, Bla GL	2	1,44	30	43,2	30	921
Treaptă / Stair	120 x 30 x 0,9	EN 14411:2012, Annex G, Bla GL	3	1,08				
Gresie porțelanată rectificată / Rectified porcelain tile	60 x 60 x 0,9	EN 14411:2012, Annex G, Bla GL	4	1,44	32	46,08	27,6	908

**RECOMANDARE / RECOMMENDATION**

 Înainte de a monta plăcile, vă sugerăm să selectați din mai multe cutii, să amestecați plăcile (inclusiv prin rotirea lor cu 180°) și să le aranjați așa cum este ilustrat în fotografia de inspirație sau să consultați site-ul [www.cesarom.ro](http://www.cesarom.ro).

 Before laying the tiles, we suggest you select from several boxes and arrange them as illustrated in the inspiration photo above or consult the [www.cesarom.ro](http://www.cesarom.ro) website and mix the tiles to achieve the required result including turning them by 180°.

**RECOMANDARE / RECOMMENDATION**

Înainte de a monta plăcile, vă sugerăm să selectați din mai multe cutii, să amestecați plăcile (inclusiv prin rotirea lor cu 180°) și să le aranjați așa cum este ilustrat în fotografia de inspirație sau să consultați site-ul [www.cesarom.ro](http://www.cesarom.ro).

Before laying the tiles, we suggest you select from several boxes and arrange them as illustrated in the inspiration photo above or consult the [www.cesarom.ro](http://www.cesarom.ro) website and mix the tiles to achieve the required result including turning them by 180°.

Produs / Product	cm	EN		m <sup>2</sup>		m <sup>2</sup>	kg	brutto kg
Gresie porțelanată rectificată / Rectified porcelain tile	60 x 30 x 0,9	EN 14411:2012, Annex G, Bla GL	7	1,26	40	50,40	23,6	960
Treaptă / Stair	60 x 30 x 0,9	EN 14411:2012, Annex G, Bla GL	6	1,08				

safe+  
99%  
ANTIBACTERIANA  
PROTECTIE

SOFT  
Touch

MATT  
NO Reflex

ABS  
Anti-slip Best  
Surface



CESAROM®



60 x 30



6460-0302  
gri/gray | mat/matt PEI 4

6460-0303  
bej/beige | mat/matt PEI 4



60 x 30



6806-0061  
gri/gray | mat/matt PEI 4

6806-0062  
bej/beige | mat/matt PEI 4



new

# Therme





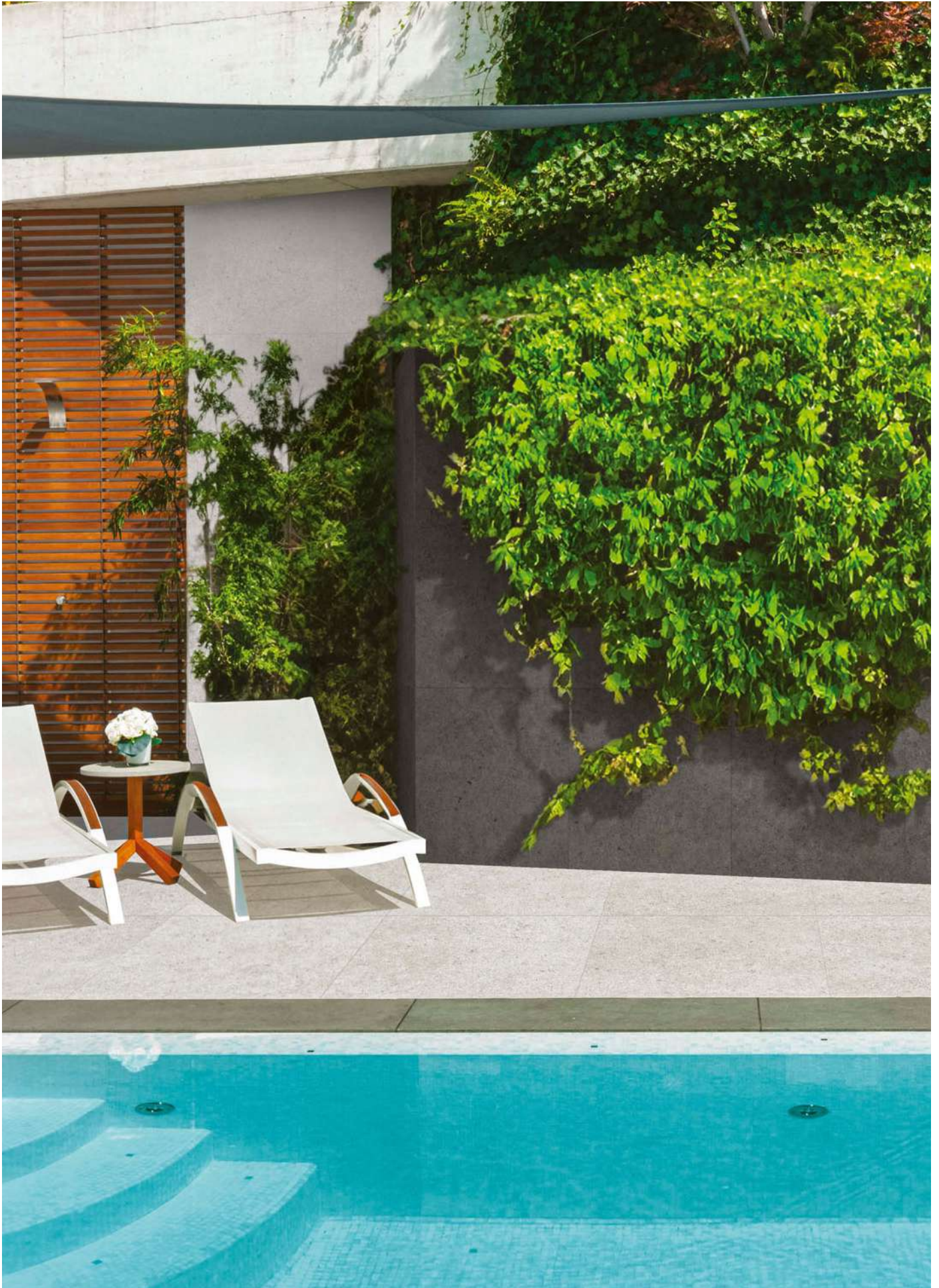





120 x 60



6493-0078 ivoriu/ivory | mat/matt PEI 5



6493-0079 gri/grey | mat/matt PEI 4



6493-0080 antracit/anthracite | mat/matt PEI 4

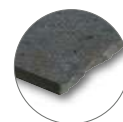

120 x 30



6895-0053 antracit/anthracite | mat/matt PEI 4

6895-0052 ivoriu/ivory | mat/matt PEI 5

6895-0051 gri/grey | mat/matt PEI 4

**activează**

**10 ani**  
garanție  
și manopera  
înapoi.

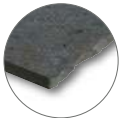
**6461-0330** ivoriu/ivory | mat/matt PEI 5**6461-0331** gri/gray | mat/matt PEI 4**6461-0332** antracit/anthracite | mat/matt PEI 4

60 x 60



V2



R11|B

Produs / Product								
Gresie porțelanată rectificată / Rectified porcelain tile	120 x 60 x 0,9	EN 14411:2012, Annex G, Bla GL	2	1,44	30	43,2	30	921
Treaptă / Stair	120 x 30 x 0,9	EN 14411:2012, Annex G, Bla GL	3	1,08				
Gresie porțelanată rectificată / Rectified porcelain tile	60 x 60 x 0,9	EN 14411:2012, Annex G, Bla GL	4	1,44	32	46,08	27,6	908

**RECOMANDARE / RECOMMENDATION**

Înainte de a monta plăcile, vă sugerăm să selectați din mai multe cutii, să amestecați plăcile (inclusiv prin rotirea lor cu 180°) și să le aranjați așa cum este ilustrat în fotografia de inspirație sau să consultați site-ul [www.cesarom.ro](http://www.cesarom.ro).

Before laying the tiles, we suggest you select from several boxes and arrange them as illustrated in the inspiration photo above or consult the [www.cesarom.ro](http://www.cesarom.ro) website and mix the tiles to achieve the required result including turning them by 180°.





**6460-0295**  
bej/beige | mat/matt PEI 4



**6806-0057**  
bej/beige | mat/matt PEI 4



Produs / Product

Gresie porțelanată rectificată / Rectified porcelain tile  
Treaptă / Stair



60 x 30 x 0,9  
60 x 30 x 0,9



EN 14411:2012, Annex G, B1a GL  
EN 14411:2012, Annex G, B1a GL



7  
6



1,26  
1,08



40



50,40



23,6



960



60 x 30



V2



R11



**6460-0294**  
gri/gray | mat/matt PEI 4

**6460-0296**  
antracit/anthracite | mat/matt PEI 4

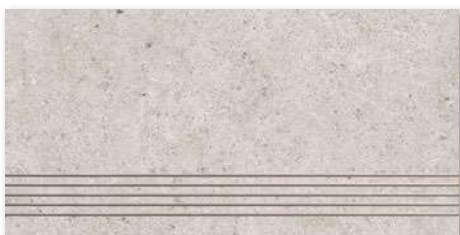

**6806-0058**  
gri/gray | mat/matt PEI 4

**6806-0059**  
antracit/anthracite | mat/matt PEI 4

**RECOMANDARE / RECOMMENDATION**

Înainte de a monta plăcile, vă sugerăm să selectați din mai multe cutii, să amestecați plăcile (inclusiv prin rotirea lor cu 180°) și să le aranjați așa cum este ilustrat în fotografia de inspirație sau să consultați site-ul [www.cesarom.ro](http://www.cesarom.ro).

Before laying the tiles, we suggest you select from several boxes and arrange them as illustrated in the inspiration photo above or consult the [www.cesarom.ro](http://www.cesarom.ro) website and mix the tiles to achieve the required result including turning them by 180°.



Produs / Product



brutto kg

Faiantă / Wall tile

60 x 30 x 0,9

EN 14411:2012, Annex K, BIII GL

7

1,26

40

50,40

23,6

960

Gresie porțelanată rectificată / Porcelain rectified tile

60 x 15 x 0,9

EN 14411:2012, Annex G, BIa GL

11

0,99

48

47,52

18,7

922



60 x 30



V2



**2060-0138**  
ivoriu/ivory | mat/matt

**2060-0137**  
gri deschis/light gray | mat/matt



**2060-0139**  
multicolor/multicolour | mat/matt

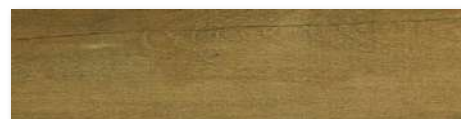

**6463-0053 Legno Miele**  
bej/beige | mat/matt PEI 4

**6463-0032 Pavimento**  
maro/brown | mat/matt PEI 4

60 x 15



V3



new

# Lux - Nero

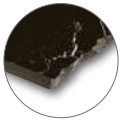





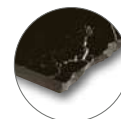

60 x 60

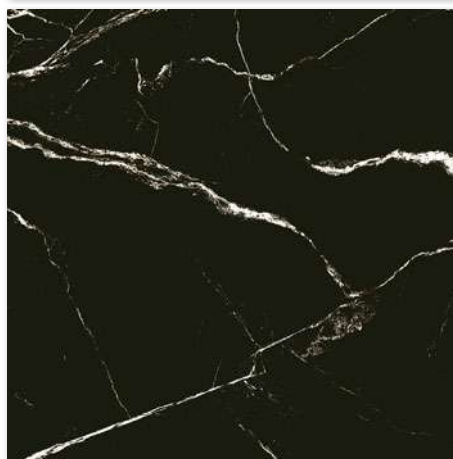

**6461-0323**  
negru/black | mat/matt | PEI 3

60 x 30

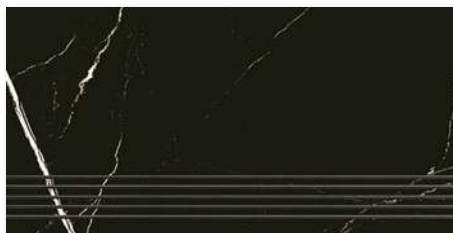
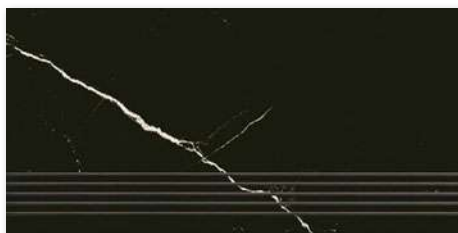

**6806-0068**  
negru/black | mat/matt PEI 3

**activează**

**10 ani**  
garanție  
și manopera  
înapoi.

Produs / Product	cm	EN		m <sup>2</sup>		m <sup>2</sup>	kg	brutto kg
Gresie portelanată rectificată / Rectified porcelain tile	60 x 60 x 0,9	EN 14411:2012, Annex G, Bla GL	4	1,44	32	46,08	27,6	908
Treaptă / Stair	60 x 30 x 0,9	EN 14411:2012, Annex G, Bla GL	6	1,08				

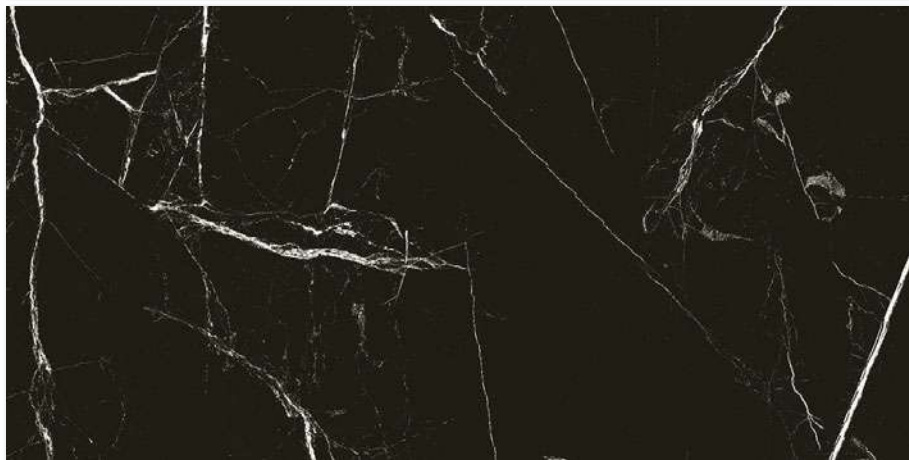

6493-0050  
negru/black | polișat/polished | PEI 3



6895-0022  
negru/black | polișat/polished | PEI 3

120 x 60



120 x 30



Produs/Product



Gresie porțelanată / Porcelain tile  
Treaptă/ Stair

120 X 60 X 0,95  
120 X 30 X 0,95

EN 14411:2012, Annex G, Bla GL  
EN 14411:2012, Annex G, Bla GL

2  
3

1,44  
1,08

30

43,2

31,5

975



new

# Lux - Spider





#### RECOMANDARE / RECOMMENDATION

Înainte de a monta plăcile, vă sugerăm să selectați din mai multe cutii, să amestecați plăcile (inclusiv prin rotirea lor cu 180°) și să le aranjați așa cum este ilustrat în fotografia de inspirație sau să consultați site-ul [www.cesarom.ro](http://www.cesarom.ro).

Before laying the tiles, we suggest you select from several boxes and arrange them as illustrated in the inspiration photo above or consult the [www.cesarom.ro](http://www.cesarom.ro) website and mix the tiles to achieve the required result including turning them by 180°.

Produs / Product	cm	EN		m <sup>2</sup>		m <sup>2</sup>	kg	brutto kg
Gresie porțelanată rectificată / Rectified porcelain tile	120 x 60 x 0,9	EN 14411:2012, Annex G, Bla GL	2	1,44	27/30	38,88/43,2	30	831/921
Treaptă / Stair	120 x 30 x 0,9	EN 14411:2012, Annex G, Bla GL	3	1,08				

## Lux - Spider





**RECOMANDARE / RECOMMENDATION**

Înainte de a monta plăcile, vă sugerăm să selectați din mai multe cutii, să amestecați plăcile (inclusiv prin rotirea lor cu 180°) și să le aranjați așa cum este ilustrat în fotografia de inspirație sau să consultați site-ul [www.cesarom.ro](http://www.cesarom.ro).

Before laying the tiles, we suggest you select from several boxes and arrange them as illustrated in the inspiration photo above or consult the [www.cesarom.ro](http://www.cesarom.ro) website and mix the tiles to achieve the required result including turning them by 180°.

new

# Lux - Spider

120 x 60



**6493-0074**  
alb/white | mat/matt | PEI 4

120 x 30



**6895-0047**  
alb/white | mat/matt | PEI 4

activează

10 ani garanție

și manopera înapoi.

Produs / Product	cm	EN		m <sup>2</sup>		m <sup>2</sup>	kg	brutto kg
Gresie porțelanată rectificată / Rectified porcelain tile	120 x 60 x 0,9	EN 14411:2012, Annex G, Bla GL	2	1,44	30	43,2	30	921
Gresie porțelanată / Porcelain tile	120 x 60 x 0,95	EN 14411:2012, Annex G, Bla GL	2	1,44	30	43,2	31,5	975
Treaptă / Stair	120 x 30 x 0,9/ 0,95	EN 14411:2012, Annex G, Bla GL	3	1,08				





**6493-0029**  
alb/white | polișat/polished | PEI 3



**6895-0026**  
alb/white | polișat/polished | PEI 3

120 x 60



120 x 30



**activează**

**10**  
an  
garanție

și manopera  
înapoi.

**RECOMANDARE / RECOMMENDATION**

Înainte de a monta plăcile, vă sugerăm să selectați din mai multe cutii, să amestecați plăcile (inclusiv prin rotirea lor cu 180°) și să le aranjați așa cum este ilustrat în fotografia de inspirație sau să consultați site-ul [www.cesarom.ro](http://www.cesarom.ro).



60 x 60



6461-0322  
alb/white | mat/matt | PEI 4



60 x 30



6806-0067  
alb/white | mat/matt PEI 4

Produs / Product



Gresie porțelanată rectificată / Rectified porcelain tile  
Treaptă / Stair

60 x 60 x 0,9  
60 x 30 x 0,9

EN 14411:2012, Annex G, Bla GL  
EN 14411:2012, Annex G, Bla GL

4  
6

1,44  
1,08

32

46,08

27,6

908



new

# Rovere





new

# Rovere

safe+  
99,99%  
ANTIBACTERIANA  
PROTECȚIE





# Rovere

120 x 20



V3



**6494-0017**  
maro/brown | mat/matt PEI 4

120 x 20



V3



**6494-0018**  
gri/greige | mat/matt PEI 4

### RECOMANDARE / RECOMMENDATION

Înainte de a monta plăcile, vă sugerăm să selectați din mai multe cutii, să amestecați plăcile (inclusiv prin rotirea lor cu 180°) și să le aranjați așa cum este ilustrat în fotografia de inspirație sau să consultați site-ul [www.cesarom.ro](http://www.cesarom.ro).

Before laying the tiles, we suggest you select from several boxes and arrange them as illustrated in the inspiration photo above or consult the [www.cesarom.ro](http://www.cesarom.ro) website and mix the tiles to achieve the required result including turning them by 180°.

activează  
  
**10** ani  
 garanție  
 și manopera  
 înapoi.

Produs / Product	cm	EN		m <sup>2</sup>		m <sup>2</sup>	kg	brutto kg
Gresie porțelanată rectificată / Rectified porcelain tile	120 x 20 x 0,9	EN 14411:2012, Annex G, Bla GL	4	0,96	32	30,72	20,0	661
Mosaic porțelanat / Porcelain mosaic	30 x 30 x 0,9	A.T. nr. 003-04/484-2021	4 SET	0,36				





**6460-0284**  
maro/brown | mat/matt PEI 4



**6460-0285**  
grej/greige | mat/matt PEI 4



60 x 30



**6463-0037**  
maro/brown | mat/matt PEI 4



**6463-0043**  
grej/greige | mat/matt PEI 4



60 x 15



**6100-0105**  
maro/brown | mat/matt  
SET = 1 folie PEI 4



**6100-0106**  
grej/greige | mat/matt  
SET = 1 folie PEI 4

30 x 30



Produs / Product



EN



m<sup>2</sup>



m<sup>2</sup>

kg

brutto kg

Gresie porțelanată rectificată / Rectified porcelain tile

60 x 30 x 0,9

EN 14411:2012, Annex G, Bla GL

7

1,26

40

50,40

23,6

960

Gresie porțelanată rectificată / Porcelain rectified tile

60 x 15 x 0,9

EN 14411:2012, Annex G, Bla GL

11

0,99

48

47,52

18,7

922

Mozaic porțelanat / Porcelain mosaic

30 x 30 x 0,9







A.T. nr. 003-04/484-2021

4 SET

0,36

# Lux - Arctic



Produs / Product	 cm	 EN		 m <sup>2</sup>		 m <sup>2</sup>	 kg	 brutto kg
Gresie porțelanată / Porcelain tile	120 x 60 x 0,95	EN 14411:2012, Annex G, Bla GL	2	1,44	30	43,2	31,5	975
Treaptă / Stair	120 x 30 x 0,95	EN 14411:2012, Annex G, Bla GL	3	1,08	-	-	-	-



120 x 60



**6493-0028**  
gri/gray | polișat/polished | 4 fețe/faces PEI 3



**6895-0024**  
gri/gray | polișat/polished | 8 fețe/faces PEI 3

120 x 30

**RECOMANDARE / RECOMMENDATION**

Înainte de a monta plăcile, vă sugerăm să selectați din mai multe cutii, să amestecați plăcile (inclusiv prin rotirea lor cu 180°) și să le aranjați așa cum este ilustrat în fotografia de inspirație sau să consultați site-ul [www.cesarom.ro](http://www.cesarom.ro).

Before laying the tiles, we suggest you select from several boxes and arrange them as illustrated in the inspiration photo above or consult the [www.cesarom.ro](http://www.cesarom.ro) website and mix the tiles to achieve the required result including turning them by 180°.

# Lux - Arctic



Produs / Product								
Gresie porțelanată / Porcelain tile	120 x 60 x 0,95	EN 14411:2012, Annex G, Bla GL	2	1,44	30	43,2	31,5	975
Treaptă / Stair	120 x 30 x 0,95	EN 14411:2012, Annex G, Bla GL	3	1,08	-	-	-	-



120 x 60



**6493-0026**  
bej/beige | polișat/polished | PEI 3



**6895-0023**  
bej/beige | polișat/polished | PEI 3

120 x 30





**RECOMANDARE / RECOMMENDATION**

Înainte de a monta plăcile, vă sugerăm să selectați din mai multe cutii, să amestecați plăcile (inclusiv prin rotirea lor cu 180°) și să le aranjați așa cum este ilustrat în fotografia de inspirație sau să consultați site-ul [www.cesarom.ro](http://www.cesarom.ro).

Before laying the tiles, we suggest you select from several boxes and arrange them as illustrated in the inspiration photo above or consult the [www.cesarom.ro](http://www.cesarom.ro) website and mix the tiles to achieve the required result including turning them by 180°.

# Lux - Calacatta Gold



Produs / Product								
Gresie porțelanată / Porcelain tile	120 x 60 x 0,95	EN 14411:2012, Annex G, Bla GL	2	1,44	30	43,2	31,5	975
Treaptă / Stair	120 x 30 x 0,95	EN 14411:2012, Annex G, Bla GL	3	1,08	-	-	-	-



120 x 60



**6493-0048**  
alb/white | polișat/polished | PEI 3



120 x 30



**6895-0020**  
alb/white | polișat/polished | PEI 3

**RECOMANDARE / RECOMMENDATION**

Înainte de a monta plăcile, vă sugerăm să selectați din mai multe cutii, să amestecați plăcile (inclusiv prin rotirea lor cu 180°) și să le aranjați așa cum este ilustrat în fotografia de inspirație sau să consultați site-ul [www.cesarom.ro](http://www.cesarom.ro).

Before laying the tiles, we suggest you select from several boxes and arrange them as illustrated in the inspiration photo above or consult the [www.cesarom.ro](http://www.cesarom.ro) website and mix the tiles to achieve the required result including turning them by 180°.

# Lux - Dyno



Produs / Product								
Gresie porțelanată / Porcelain tile	120 x 60 x 0,95	EN 14411:2012, Annex G, Bla GL	2	1,44	30	43,2	31,5	975
Treaptă / Stair	120 x 30 x 0,95	EN 14411:2012, Annex G, Bla GL	3	1,08	-	-	-	-





120 x 60



V4



**6493-0032**  
bej/beige | polișat/polished | PEI 3



**6895-0028**  
bej/beige | polișat/polished | PEI 3

120 x 30



V4



**RECOMANDARE / RECOMMENDATION**

Înainte de a monta plăcile, vă sugerăm să selectați din mai multe cutii, să amestecați plăcile (inclusiv prin rotirea lor cu 180°) și să le aranjați așa cum este ilustrat în fotografia de inspirație sau să consultați site-ul [www.cesarom.ro](http://www.cesarom.ro).

Before laying the tiles, we suggest you select from several boxes and arrange them as illustrated in the inspiration photo above or consult the [www.cesarom.ro](http://www.cesarom.ro) website and mix the tiles to achieve the required result including turning them by 180°.

## Lux - Marble



Produs / Product								
Gresie porțelanată / Porcelain tile	120 x 60 x 0,95	EN 14411:2012, Annex G, Bla GL	2	1,44	30	43,2	31,5	975
Treaptă / Stair	120 x 30 x 0,95	EN 14411:2012, Annex G, Bla GL	3	1,08	-	-	-	-



120 x 60



**6493-0027**  
gri închis/dark gray | polișat/polished | PEI 3



**6895-0025**  
gri închis/dark gray | polișat/polished | PEI 3

120 x 30



**RECOMANDARE / RECOMMENDATION**

Înainte de a monta plăcile, vă sugerăm să selectați din mai multe cutii, să amestecați plăcile (inclusiv prin rotirea lor cu 180°) și să le aranjați așa cum este ilustrat în fotografia de inspirație sau să consultați site-ul [www.cesarom.ro](http://www.cesarom.ro).

Before laying the tiles, we suggest you select from several boxes and arrange them as illustrated in the inspiration photo above or consult the [www.cesarom.ro](http://www.cesarom.ro) website and mix the tiles to achieve the required result including turning them by 180°.

# Lux - Mirage



Produs / Product	 cm	 EN		 m <sup>2</sup>		 m <sup>2</sup>	 kg	 brutto kg
Gresie porțelanată / Porcelain tile	120 x 60 x 0,95	EN 14411:2012, Annex G, Bla GL	2	1,44	30	43,2	31,5	975
Treaptă / Stair	120 x 30 x 0,95	EN 14411:2012, Annex G, Bla GL	3	1,08	-	-	-	-



120 x 60



**6493-0053**  
alb/white | polișat/polished | PEI 3



**6895-0043**  
alb/white | polișat/polished | PEI 3

120 x 30



**RECOMANDARE / RECOMMENDATION**

Înainte de a monta plăcile, vă sugerăm să selectați din mai multe cutii, să amestecați plăcile (inclusiv prin rotirea lor cu 180°) și să le aranjați așa cum este ilustrat în fotografia de inspirație sau să consultați site-ul [www.cesarom.ro](http://www.cesarom.ro).

Before laying the tiles, we suggest you select from several boxes and arrange them as illustrated in the inspiration photo above or consult the [www.cesarom.ro](http://www.cesarom.ro) website and mix the tiles to achieve the required result including turning them by 180°.

# Lux - Onix



Produs / Product								
Gresie porțelanată / Porcelain tile	120 x 60 x 0,95	EN 14411:2012, Annex G, Bla GL	2	1,44	30	43,2	31,5	975
Treaptă / Stair	120 x 30 x 0,95	EN 14411:2012, Annex G, Bla GL	3	1,08	-	-	-	-



120 x 60



**6493-0049**  
bej/beige | polișat/polished | PEI 3



**6895-0021**  
bej/beige | polișat/polished | PEI 3

120 x 30



**RECOMANDARE / RECOMMENDATION**

Înainte de a monta plăcile, vă sugerăm să selectați din mai multe cutii, să amestecați plăcile (inclusiv prin rotirea lor cu 180°) și să le aranjați așa cum este ilustrat în fotografia de inspirație sau să consultați site-ul [www.cesarom.ro](http://www.cesarom.ro).

Before laying the tiles, we suggest you select from several boxes and arrange them as illustrated in the inspiration photo above or consult the [www.cesarom.ro](http://www.cesarom.ro) website and mix the tiles to achieve the required result including turning them by 180°.

# Lux - Portoro



Produs / Product								
Gresie porțelanată / Porcelain tile	120 x 60 x 0,95	EN 14411:2012, Annex G, Bla GL	2	1,44	30	43,2	31,5	975
Treaptă / Stair	120 x 30 x 0,95	EN 14411:2012, Annex G, Bla GL	3	1,08	-	-	-	-





120 x 60

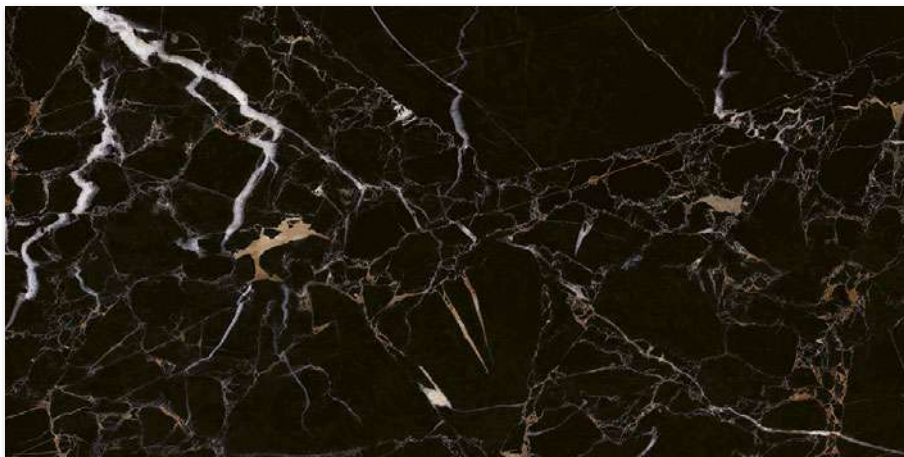

**6493-0054**  
negru/black | lucios/glossy | PEI 3



**6895-0044**  
negru/black | lpolișat/polished | PEI 3

120 x 30



**RECOMANDARE / RECOMMENDATION**

Înainte de a monta plăcile, vă sugerăm să selectați din mai multe cutii, să amestecați plăcile (inclusiv prin rotirea lor cu 180°) și să le aranjați așa cum este ilustrat în fotografia de inspirație sau să consultați site-ul [www.cesarom.ro](http://www.cesarom.ro).

Before laying the tiles, we suggest you select from several boxes and arrange them as illustrated in the inspiration photo above or consult the [www.cesarom.ro](http://www.cesarom.ro) website and mix the tiles to achieve the required result including turning them by 180°.





## RECOMANDARE / RECOMMENDATION

Înainte de a monta plăcile, vă sugerăm să selectați din mai multe cutii, să amestecați plăcile (inclusiv prin rotirea lor cu 180°) și să le aranjați așa cum este ilustrat în fotografia de inspirație sau să consultați site-ul [www.cesarom.ro](http://www.cesarom.ro).

Before laying the tiles, we suggest you select from several boxes and arrange them as illustrated in the inspiration photo above or consult the [www.cesarom.ro](http://www.cesarom.ro) website and mix the tiles to achieve the required result including turning them by 180°.

Produs / Product	cm	EN		m <sup>2</sup>		m <sup>2</sup>	kg	brutto kg
Gresie porțelanată rectificată / Rectified porcelain tile	60 x 30 x 0,9	EN 14411:2012, Annex G, Bla GL	7	1,26	40	50,40	23,6	960
Treaptă / Stair	60 x 30 x 0,9	EN 14411:2012, Annex G, Bla GL	6	1,08				

safe+  
99,9%  
PROTECȚIE ANTIBACTERIANĂ

SOFT  
Touch

MATT  
NO Reflex

ABS  
Anti-slip Best  
Surface



CESAROM®



60 x 30



6460-0300  
gri/gray | mat/matt PEI 4

6460-0301  
antracit/anthracite | mat/matt PEI 4



6806-0054  
gri/gray | mat/matt PEI 4

6806-0055  
antracit/anthracite | mat/matt PEI 4





#### RECOMANDARE / RECOMMENDATION

Înainte de a monta plăcile, vă sugerăm să selectați din mai multe cutii, să amestecați plăcile (inclusiv prin rotirea lor cu 180°) și să le aranjați așa cum este ilustrat în fotografia de inspirație sau să consultați site-ul [www.cesarom.ro](http://www.cesarom.ro).

Before laying the tiles, we suggest you select from several boxes and arrange them as illustrated in the inspiration photo above or consult the [www.cesarom.ro](http://www.cesarom.ro) website and mix the tiles to achieve the required result including turning them by 180°.

Produs / Product	cm	EN		m <sup>2</sup>		m <sup>2</sup>	kg	brutto kg
Gresie porțelanată rectificată / Rectified porcelain tile	60 x 30 x 0,9	EN 14411:2012, Annex G, Bla GL	7	1,26	40	50,40	23,6	960
Treaptă / Stair	60 x 30 x 0,9	EN 14411:2012, Annex G, Bla GL	6	1,08				

safe+  
99%  
PROTECȚIE  
ANTIBACTERIANĂ

SOFT  
Touch

MATT  
NO Reflex

ABS  
Anti-slip Best  
Surface



CESAROM®

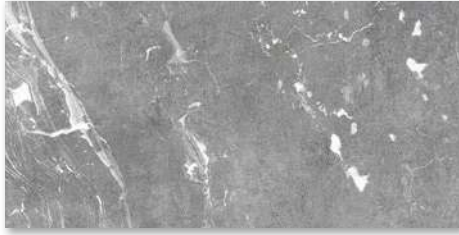

6460-0299  
gri/gray | mat/matt PEI 4

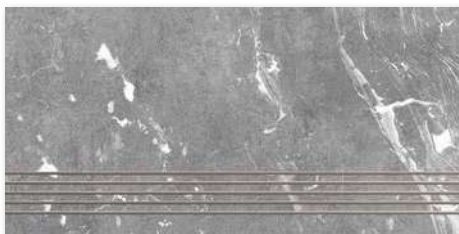

6806-0053  
gri/gray | mat/matt PEI 4

60 x 30





## RECOMANDARE / RECOMMENDATION

Înainte de a monta plăcile, vă sugerăm să selectați din mai multe cutii, să amestecați plăcile (inclusiv prin rotirea lor cu 180°) și să le aranjați așa cum este ilustrat în fotografia de inspirație sau să consultați site-ul [www.cesarom.ro](http://www.cesarom.ro).

Before laying the tiles, we suggest you select from several boxes and arrange them as illustrated in the inspiration photo above or consult the [www.cesarom.ro](http://www.cesarom.ro) website and mix the tiles to achieve the required result including turning them by 180°.

Produs / Product	cm	EN		m <sup>2</sup>		m <sup>2</sup>	kg	brutto kg
Gresie porțelanată rectificată / Rectified porcelain tile	60 x 30 x 0,9	EN 14411:2012, Annex G, Bla GL	7	1,26	70	50,40	23,6	960
Gresie porțelanată rectificată / Porcelain rectified tile	60 x 15 x 0,9	EN 14411:2012, Annex G, Bla GL	11	0,99	48	47,52	18,7	922



6460-0288  
bej/beigel mat/matt PEI 4



6460-0287  
maro-gri/brown-gray | mat/matt PEI 4



60 x 30



V3



6463-0041  
bej/beige | mat/matt PEI 4



6463-0042  
maro-gri/brown-gray | mat/matt PEI 4



60 x 15



V3

# Legno Miele



Produs / Product



Gresie porțelanată rectificată / Porcelain rectified tile  
 Mozaic porțelanat / Porcelain mosaic

60 x 15 x 0,9  
 30 x 30 x 0,9

EN 14411:2012, Annex G, Bla GL  
 A.T. nr. 003-04/484-2021

11  
 4 SET

0,99  
 0,36

48

47,52

18,7

922





60 x 15



6463-0053  
bej/beige | mat/matt PEI 4



30 x 30



6100-0115  
bej/beige | mat/matt  
SET = 1 folie PEI 4

RECOMANDARE / RECOMMENDATION

Înainte de a monta plăcile, vă sugerăm să selectați din mai multe cutii, să amestecați plăcile (inclusiv prin rotirea lor cu 180°) și să le aranjați așa cum este ilustrat în fotografia de inspirație sau să consultați site-ul [www.cesarom.ro](http://www.cesarom.ro).

Before laying the tiles, we suggest you select from several boxes and arrange them as illustrated in the inspiration photo above or consult the [www.cesarom.ro](http://www.cesarom.ro) website and mix the tiles to achieve the required result including turning them by 180°.

# Pavimento







**6463-0033**  
gri/gray | mat/matt PEI 4



**6100-0109**  
gri /gray | mat/matt  
SET = 1 folie PEI 4

Produs / Product



Gresie porțelanată rectificată / Porcelain rectified tile  
Mozaic porțelanat / Porcelain mosaic

60 x 15 x 0,9  
30 x 30 x 0,9

EN 14411:2012, Annex G, Bla GL  
A.T. nr. 003-04/484-2021

11  
4 SET

0,99  
0,36

48

47,52

18,7

922



**6463-0031**  
bej/beige | mat/matt PEI 4



**6463-0032**  
maro/brown | mat/matt PEI 4

60 x 15



**6100-0107**  
bej/beige | mat/matt  
SET = 1 folie PEI 4



**6100-0108**  
maro/brown | mat/matt  
SET = 1 folie PEI 4

30 x 30



**RECOMANDARE / RECOMMENDATION**

Înainte de a monta plăcile, vă sugerăm să selectați din mai multe cutii, să amestecați plăcile (inclusiv prin rotirea lor cu 180°) și să le aranjați așa cum este ilustrat în fotografia de inspirație sau să consultați site-ul [www.cesarom.ro](http://www.cesarom.ro).

Before laying the tiles, we suggest you select from several boxes and arrange them as illustrated in the inspiration photo above or consult the [www.cesarom.ro](http://www.cesarom.ro) website and mix the tiles to achieve the required result including turning them by 180°.

# Crust



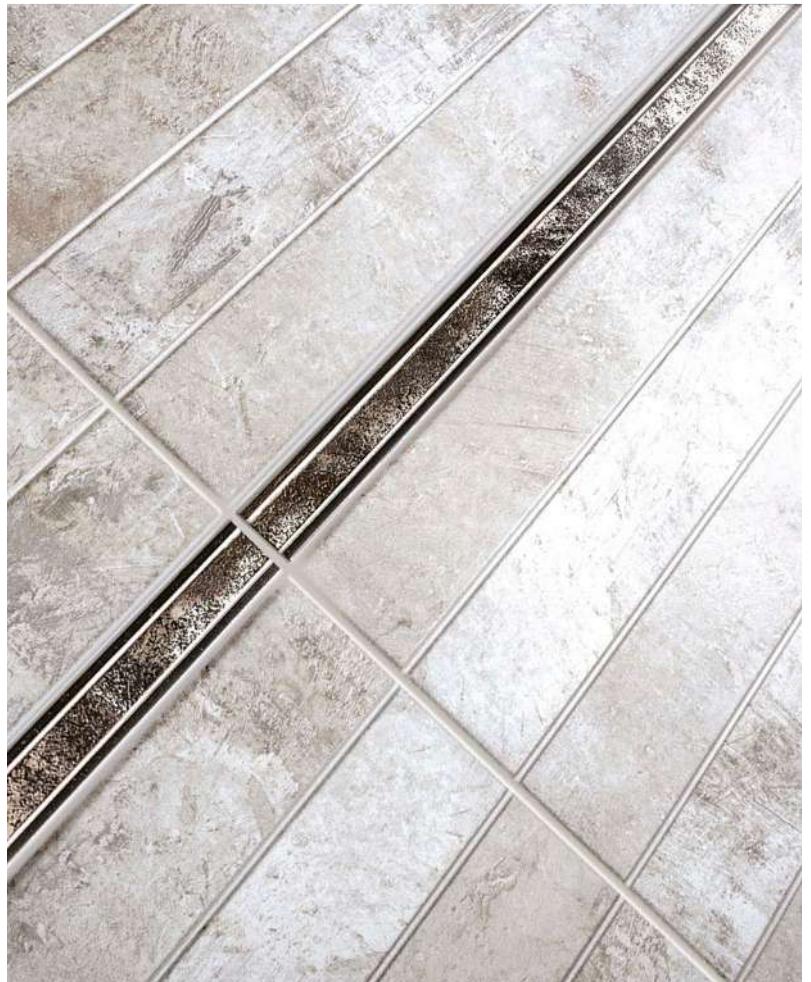



# Crust



## RECOMANDARE / RECOMMENDATION

Înainte de a monta plăcile, vă sugerăm să selectați din mai multe cutii, să amestecați plăcile (inclusiv prin rotirea lor cu 180°) și să le aranjați așa cum este ilustrat în fotografia de inspirație sau să consultați site-ul [www.cesarom.ro](http://www.cesarom.ro).

Before laying the tiles, we suggest you select from several boxes and arrange them as illustrated in the inspiration photo above or consult the [www.cesarom.ro](http://www.cesarom.ro) website and mix the tiles to achieve the required result including turning them by 180°.

Produs / Product	cm	EN		m <sup>2</sup>		m <sup>2</sup>	kg	brutto kg
Gresie porțelanată rectificată / Rectified porcelain tile	60 x 30 x 0,9	EN 14411:2012, Annex G, Bla GL	7	1,26	40	50,40	23,6	960
Mozaic porțelanat / Porcelain mosaic	30 x 30 x 0,9	A.T. nr. 003-04/484-2021	4 SET	0,36				
Treaptă / Stairs	60 x 30 x 0,9	EN 14411:2012, Annex G, Bla GL	6	1,08				
Gresie porțelanată / Porcelain tile	45 x 45 x 0,9	EN 14411:2012, Annex G, Bla GL	7	1,42	52	73,84	26,3	1395





6060-0190  
gri/gray | mat/matt PEI 4



6460-0271



6060-0211  
gri/gray | mat/matt PEI 4



6460-0272



30 x 30  
  
  
  
V3



6100-0088  
gri/gray | mat/matt  
SET = 1 folie PEI 4



6060-0191  
gri/gray | mat/matt PEI 5



6806-0037  
gri/gray | mat/matt PEI 4

60 x 30  
  
  
V3

45 x 45  
  
  
V3



6046-0366  
gri/gray | mat/matt PEI 5



# Essential











# Essential



## RECOMANDARE / RECOMMENDATION

Înainte de a monta plăcile, vă sugerăm să selectați din mai multe cutii, să amestecați plăcile (inclusiv prin rotirea lor cu 180°) și să le aranjați așa cum este ilustrat în fotografia de inspirație sau să consultați site-ul [www.cesarom.ro](http://www.cesarom.ro).

Before laying the tiles, we suggest you select from several boxes and arrange them as illustrated in the inspiration photo above or consult the [www.cesarom.ro](http://www.cesarom.ro) website and mix the tiles to achieve the required result including turning them by 180°.

Produs / Product	cm	EN						
				m <sup>2</sup>		m <sup>2</sup>	kg	brutto kg
Gresie porțelanată rectificată / Rectified porcelain tile	60 x 30 x 0,9	EN 14411:2012, Annex G, Bla GL	7	1,26	40	50,40	23,6	960
Gresie porțelanată rectificată / Porcelain rectified tile	60 x 15 x 0,9	EN 14411:2012, Annex G, Bla GL	11	0,99	48	47,52	18,7	922
Mozaic porțelanat / Porcelain mosaic	30 x 30 x 0,9	A.T. nr. 003-04/484-2021	4 SET	0,36				



60 x 30



6060-0333  
gri/gray | mat-lucios/matt-glossy PEI 4

6460-0279

6060-0335  
indigo/indigo | mat-lucios/matt-glossy PEI 4

6460-0280



6060-0334  
multicolor/multicolour | mat-lucios/matt-glossy PEI 5

60 x 15



6463-0031 Pavimento  
bej/beige | mat/matt PEI 4



30 x 30



6100-0093  
gri/gray | mat-lucios/matt-glossy  
SET = 1 folie PEI 4



# Move





# Move



## RECOMANDARE / RECOMMENDATION

Înainte de a monta plăcile, vă sugerăm să selectați din mai multe cutii, să amestecați plăcile (inclusiv prin rotirea lor cu 180°) și să le aranjați așa cum este ilustrat în fotografia de inspirație sau să consultați site-ul [www.cesarom.ro](http://www.cesarom.ro).

Before laying the tiles, we suggest you select from several boxes and arrange them as illustrated in the inspiration photo above or consult the [www.cesarom.ro](http://www.cesarom.ro) website and mix the tiles to achieve the required result including turning them by 180°.

Produs / Product	cm	EN		m <sup>2</sup>		m <sup>2</sup>	kg	brutto kg
Gresie porțelanată rectificată / Rectified porcelain tile	60 x 30 x 0,9	EN 14411:2012, Annex G, Bla GL	7	1,26	40	50,40	23,6	960
Brâu metalic / Metalic listel	60 x 3 x 1	EN 14411:2012, Annex G, Bla GL	6	0,11				
Mozaic porțelanat / Porcelain mosaic	30 x 30 x 0,9	A.T. nr. 003-04/484-2021	4 SET	0,36				





6060-0283  
gri/gray | mat/matt PEI 4

6460-0276



6060-0284  
antracit/anthracite | mat/matt PEI 3

6460-0277

60 x 30



6060-0281  
antracit/anthracite | mat/matt PEI 3



6606-0036 Metallic PEI 3

60 x 3

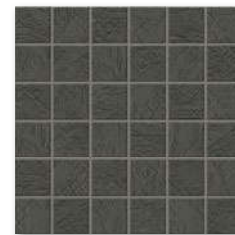

6100-0092  
antracit/anthracite | mat/matt  
SET = 1 folie PEI 3

30 x 30



# Piedra



## RECOMANDARE / RECOMMENDATION

Înainte de a monta plăcile, vă sugerăm să selectați din mai multe cutii, să amestecați plăcile (inclusiv prin rotirea lor cu 180°) și să le aranjați așa cum este ilustrat în fotografia de inspirație sau să consultați site-ul [www.cesarom.ro](http://www.cesarom.ro).

Before laying the tiles, we suggest you select from several boxes and arrange them as illustrated in the inspiration photo above or consult the [www.cesarom.ro](http://www.cesarom.ro) website and mix the tiles to achieve the required result including turning them by 180°.

Produs / Product	cm	EN		m <sup>2</sup>		m <sup>2</sup>	kg	brutto kg
Gresie porțelanată rectificată // Rectified porcelain tile	60 x 30 x 0,9	EN 14411:2012, Annex G, Bla GL	7	1,26	40	50,40	23,6	960
Gresie porțelanată // Porcelain tile	45 x 45 x 0,9	EN 14411:2012, Annex G, Bla GL	7	1,42	52	73,84	26,3	1395
Mozaic porțelanat / Porcelain mosaic	30 x 30 x 0,9	A.T. nr. 003-04/484-2021	4 SET	0,36				
Treaptă / Stair	60 x 30 x 0,9	EN 14411:2012, Annex G, Bla GL	6	1,08				



60 x 30



**6460-0273**  
gri/gray | mat/matt PEI 4

**6460-0274**  
bej/beige | mat/matt PEI 4



60 x 30



**6806-0040**  
gri/gray | mat/matt PEI 4

**6806-0041**  
bej/beige | mat/matt PEI 4



30 x 30



**6100-0084**  
gri/gray | mat/matt  
SET = 1 folie PEI 4

**6100-0085**  
bej/beige | mat/matt  
SET = 1 folie PEI 4

# Quartz



## RECOMANDARE / RECOMMENDATION

Înainte de a monta plăcile, vă sugerăm să selectați din mai multe cutii, să amestecați plăcile (inclusiv prin rotirea lor cu 180°) și să le aranjați așa cum este ilustrat în fotografia de inspirație sau să consultați site-ul [www.cesarom.ro](http://www.cesarom.ro).

Before laying the tiles, we suggest you select from several boxes and arrange them as illustrated in the inspiration photo above or consult the [www.cesarom.ro](http://www.cesarom.ro) website and mix the tiles to achieve the required result including turning them by 180°.

Produs / Product	cm	EN		m <sup>2</sup>		m <sup>2</sup>	kg	brutto kg
Gresie porțelanată rectificată / Rectified porcelain tile	60 x 30 x 0,9	EN 14411:2012, Annex G, Bla GL	7	1,26	40	50,40	23,6	960
Mozaic porțelanat / Porcelain mosaic	30 x 30 x 0,9	A.T. nr. 003-04/484-2021	4 SET	0,36				
Treaptă / Stair	60 x 30 x 0,9	EN 14411:2012, Annex G, Bla GL	6	1,08				



**6460-0267**  
gri/greige | mat/matt PEI 4



**6460-0268**  
gri închis/dark gray | mat/matt PEI 4



60 x 30



**6460-0289**  
multicolor/multicolour | mat/matt PEI 4



**6806-0042**  
gri/greige | mat/matt PEI 4



**6806-0043**  
gri închis/dark gray | mat/matt PEI 4



**6100-0095**  
gri/greige | mat/matt  
SET = 1 folie PEI 4



**6100-0096**  
gri închis/dark gray | mat/matt  
SET = 1 folie PEI 4

30 x 30



# Statuario





# Statuario



## RECOMANDARE / RECOMMENDATION

Înainte de a monta plăcile, vă sugerăm să selectați din mai multe cutii, să amestecați plăcile (inclusiv prin rotirea lor cu 180°) și să le aranjați așa cum este ilustrat în fotografia de inspirație sau să consultați site-ul [www.cesarom.ro](http://www.cesarom.ro).

Before laying the tiles, we suggest you select from several boxes and arrange them as illustrated in the inspiration photo above or consult the [www.cesarom.ro](http://www.cesarom.ro) website and mix the tiles to achieve the required result including turning them by 180°.

Produs / Product	cm	EN		m <sup>2</sup>		m <sup>2</sup>	kg	brutto kg
Faianță / Wall tile	50 x 25 x 0,9	EN 14411:2012, Annex K, BIII GL	11	1,38	45	62,10	21,0	970
Decor / Insert	50 x 25 x 0,9	EN 14411:2012, Annex K, BIII GL	9	1,25				
Decor / Insert	50 x 25 x 0,9	EN 14411:2012, Annex K, BIII GL	3 SET	1,13				
Mozaic / Mosaic	30 x 29 x 0,9	A.T. nr. 003-04/485-2022	4 SET	0,22				
Gresie / Floor tile	45 x 45 x 0,9	EN 14411:2012, Annex K, BIII GL	7	1,42	52	73,84	23,7	1257





**2051-0207**  
alb/white | lucios/glossy



**2651-0106**  
aur/gold | lucios/glossy



**2051-0208**  
alb/white | lucios/glossy



50 x 25



30 x 29,5



**2600-0109**  
alb/white | lucios/glossy  
SET = 1 folie

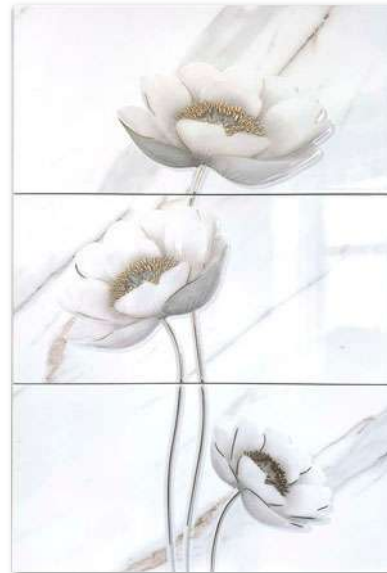

**2651-0107**  
alb/white | lucios/glossy  
SET = 3 buc



**2505-0125**  
auriu/gold | lucios/glossy

50 x 2,5



**4646-0101**  
alb/white | lucios/glossy PEI 3

SET = 2 buc



**4046-0131**  
alb/white | lucios/glossy PEI 3

45 x 45



# Statuario



Produs / Product



EN



m<sup>2</sup>



m<sup>2</sup>

kg

brutto kg

Gresie porțelanată rectificată / Rectified porcelain tile

60 x 30 x 0,9

EN 14411:2012, Annex G, Bla GL

7

1,26

40

50,40

23,6

960

Brâu / Listel

60 x 3 x 1

EN 14411:2012, Annex G, Bla GL

6

0,11

Mozaic porțelanat / Porcelain mosaic

30 x 30 x 0,9

A.T. nr. 003-04/484-2021

4 SET

0,36

Treaptă / Stair

60 x 30 x 0,9

EN 14411:2012, Annex G, Bla GL

6

1,08



6060-0351  
alb/white | mat/matt PEI 4



6460-0275



6060-0352  
alb/white | mat/matt PEI 4



6606-0036 Metallic PEI 3



6806-0045  
alb/white | mat/matt PEI 4

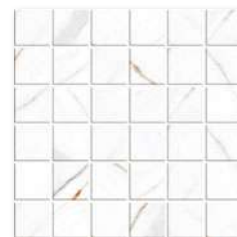

6100-0094  
alb/white | mat/matt  
SET = 1 folie PEI 4

60 x 30



60 x 3



60 x 30



30 x 30



# Tanum & Terrazzo





# Tanum & Terrazzo

60 x 30



V2



**2060-0109**  
gri deschis/light gray | mat/matt



**2060-0110**  
gri deschis/light gray | mat/matt

60 x 30



V3



**2060-0133 Unique**  
bej/beige | mat/matt



**2660-0102**  
gri/gray | mat/matt

activează

10 ani garanție și manopera înapoi.

Produs / Product	cm	EN		m <sup>2</sup>		m <sup>2</sup>	kg	brutto kg
Faianță / Wall tile	60 x 30 x 0,9	EN 14411:2012, Annex K, BIII GL	7	1,26	40	50,40	23,6	960
Decor / Insert	60 x 30 x 0,9	EN 14411:2012, Annex K, BIII GL	6	1,08				
Brău metalic / Metallic listel	60 x 3 x 1	EN 14411:2012, Annex G, BIIa GL	6	0,11				
Gresie porțelanată rectificată / Rectified porcelain tile	60 x 30 x 0,9	EN 14411:2012, Annex G, BIIa GL	7	1,26	40	50,40	23,6	960



6060-0125  
antracit/anthracite | mat/matt PEI 4

6460-0270



6060-0124  
gri deschis/light gray | mat/matt PEI 5

6460-0269

60 x 30



6806-0047  
antracit/anthracite | mat/matt PEI 4

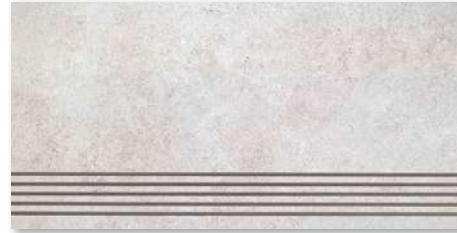

6806-0046  
gri deschis/light gray | mat/matt PEI 5



6060-0210 Terrazzo  
multicolor/multicolour | mat/mat PEI 5



6100-0089  
gri deschis/light gray | mat/matt  
SET = 1 folie PEI 5



6035-0181  
gri deschis/light gray | mat/matt PEI 5

33 x 33



6606-0036 Metallic PEI 3

60 x 3



SL



6100-0090  
bej/beige | mat/matt  
SET = 1 folie PEI 4

SL



6060-0126  
bej/beige | mat/matt PEI 4

60 x 30



Produs / Product	cm	EN		m <sup>2</sup>		m <sup>2</sup>	kg	brutto kg
Gresie porțelanată rectificată / Rectified porcelain tile	60 x 30 x 0,9	EN 14411:2012, Annex G, Bla GL	7	1,26	40	50,40	23,6	960
Mosaic porțelanat / Porcelain mosaic	30 x 30 x 0,9	A.T. nr. 003-04/484-2021	4 SET	0,36				
Treaptă / Stair	60 x 30 x 0,9	EN 14411:2012, Annex G, Bla GL	6	1,08				
Gresie porțelanată / Porcelain tile	33 x 33 x 0,75	EN 14411:2012, Annex G, Bla GL	15	1,63	42	68,46	26,0	1120

# Traver

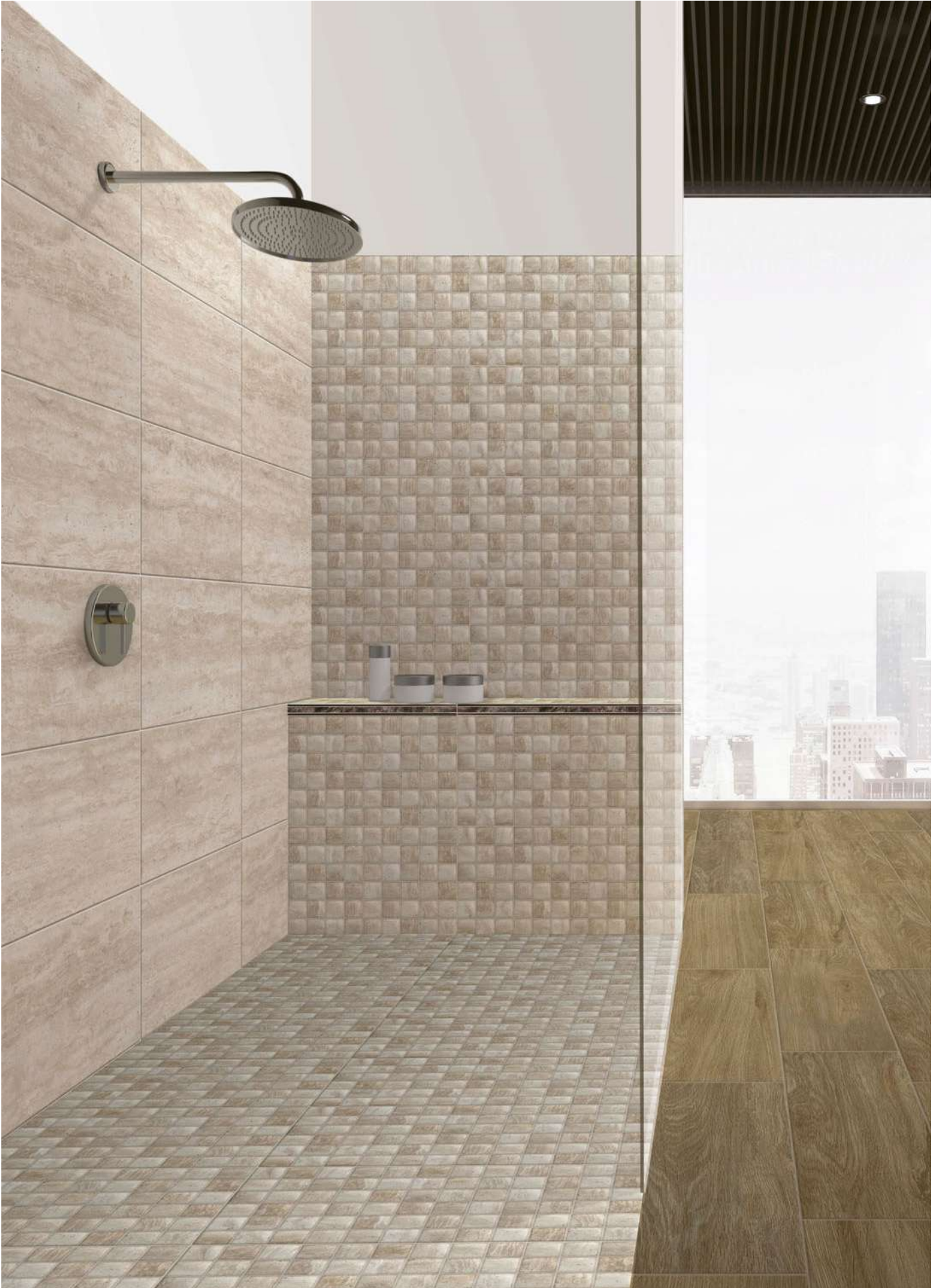







# Traver



## RECOMANDARE / RECOMMENDATION

Înainte de a monta plăcile, vă sugerăm să selectați din mai multe cutii, să amestecați plăcile (inclusiv prin rotirea lor cu 180°) și să le aranjați așa cum este ilustrat în fotografia de inspirație sau să consultați site-ul [www.cesarom.ro](http://www.cesarom.ro).

Before laying the tiles, we suggest you select from several boxes and arrange them as illustrated in the inspiration photo above or consult the [www.cesarom.ro](http://www.cesarom.ro) website and mix the tiles to achieve the required result including turning them by 180°.

Produs / Product	cm	EN		m <sup>2</sup>		m <sup>2</sup>	kg	brutto kg
Gresie porțelanată / Porcelain tile	60 x 30 x 0,9	EN 14411:2012, Annex G, Bla GL	7	1,26	40	50,40	23,6	960
Brâu metalic / Metallic listel	60 x 3 x 1	EN 14411:2012, Annex G, Bla GL	6	0,11				
Treaptă / Stair	60 x 30 x 0,9	EN 14411:2012, Annex G, Bla GL	6	1,08				



60 x 30



**6060-0202**  
bej/beige | mat/matt PEI 5

**6460-0278**



**6060-0203**  
bej/beige | mat/matt PEI 5

**6060-0336**  
multicolor/multicolour | mat/matt PEI 5



**6606-0036 Metallic** PEI 3

60 x 3



**6806-0044**  
bej/beige | mat/matt PEI 5

60 x 30



# Wright



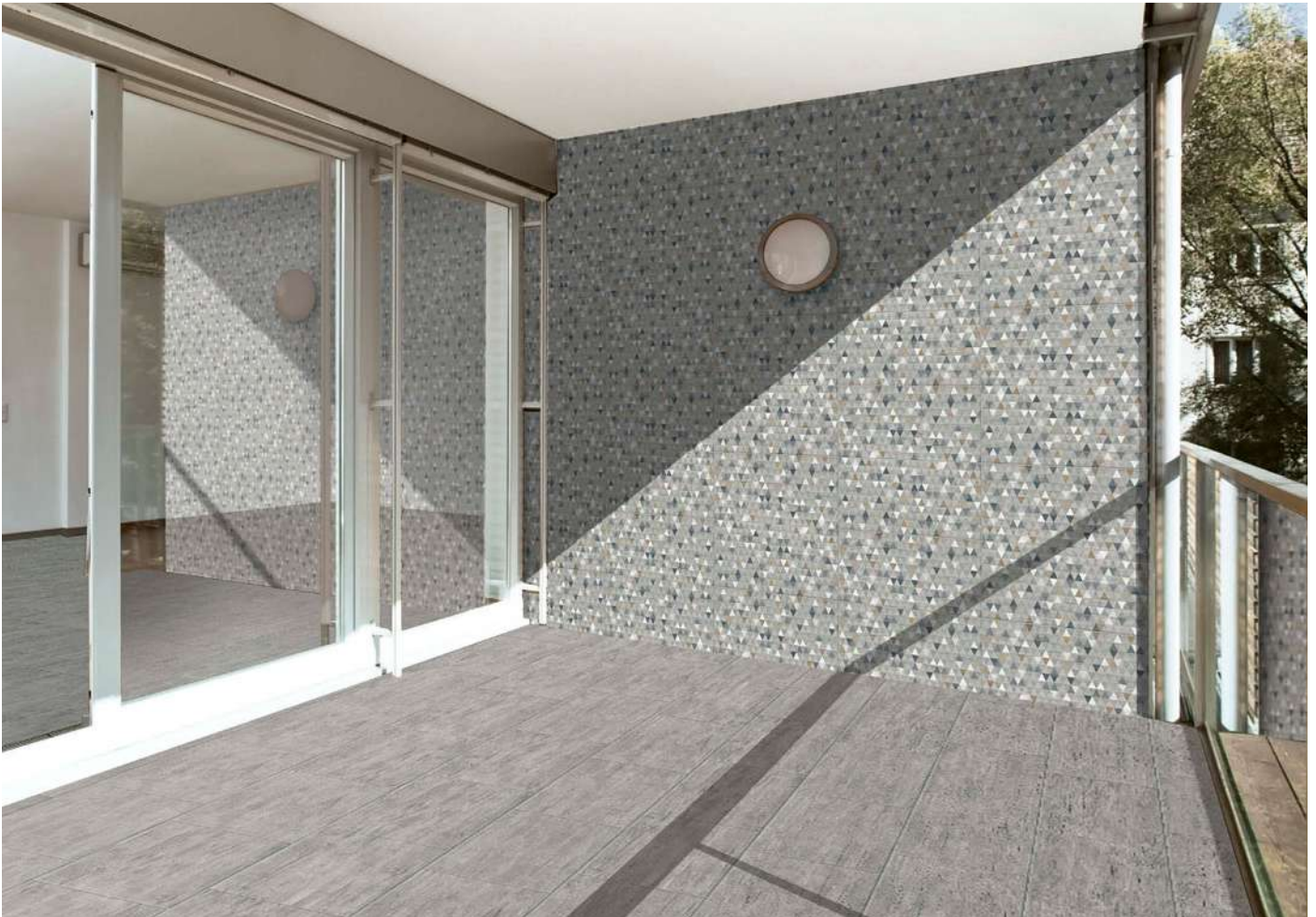

# Wright



## RECOMANDARE / RECOMMENDATION

Înainte de a monta plăcile, vă sugerăm să selectați din mai multe cutii, să amestecați plăcile (inclusiv prin rotirea lor cu 180°) și să le aranjați așa cum este ilustrat în fotografia de inspirație sau să consultați site-ul [www.cesarom.ro](http://www.cesarom.ro).

Before laying the tiles, we suggest you select from several boxes and arrange them as illustrated in the inspiration photo above or consult the [www.cesarom.ro](http://www.cesarom.ro) website and mix the tiles to achieve the required result including turning them by 180°.

Produs / Product								
Gresie porțelanată / Porcelain tile	60 x 30 x 0,9	EN 14411:2012, Annex G, Bla GL	7	1,26	40	50,40	23,6	960
Brău metalic / Metallic listel	60 x 3 x 1	EN 14411:2012, Annex G, Bla GL	6	0,11				
Mozaic porțelanat / Porcelain mosaic	30 x 30 x 0,9	A.T. nr. 003-04/484-2021	4 SET	0,36				



60 x 30



**6060-0298**  
gri/gray | mat/matt PEI 4



**6060-0300**  
multicolor/multicolour | mat/matt PEI 5



**6060-0299**  
multicolor/multicolour | mat/matt PEI 4



30 x 30



**6100-0091**  
gri/gray | mat/matt  
SET = 1 folie PEI 4



# Camino



## RECOMANDARE / RECOMMENDATION

Înainte de a monta plăcile, vă sugerăm să selectați din mai multe cutii, să amestecați plăcile (inclusiv prin rotirea lor cu 180°) și să le aranjați așa cum este ilustrat în fotografia de inspirație sau să consultați site-ul [www.cesarom.ro](http://www.cesarom.ro)

Before laying the tiles, we suggest you select from several boxes and arrange them as illustrated in the inspiration photo above or consult the [www.cesarom.ro](http://www.cesarom.ro) website and mix the tiles to achieve the required result including turning them by 180°.

Produs / Product	cm	EN		m <sup>2</sup>		m <sup>2</sup>	kg	brutto kg
Gresie porțelanată / Porcelain tile	60 x 30 x 0,9	EN 14411-2012, Annex G, Bla GL	7	1,26	40	50,40	23,6	960
Brâu metalic / Metallic listel	60 x 3 x 1	EN 14411-2012, Annex G, Bla GL	6	0,11				





SL



60 x 30



6060-0192  
bej/beige | mat/matt PEI 5

SL



6060-0193  
multicolor/multicolour | mat/matt PEI 5



6606-0036 Metallic PEI 3

60 x 3



# Canada



## RECOMANDARE / RECOMMENDATION

Înainte de a monta plăcile, vă sugerăm să selectați din mai multe cutii, să amestecați plăcile (inclusiv prin rotirea lor cu 180°) și să le aranjați așa cum este ilustrat în fotografia de inspirație sau să consultați site-ul [www.cesarom.ro](http://www.cesarom.ro).

Before laying the tiles, we suggest you select from several boxes and arrange them as illustrated in the inspiration photo above or consult the [www.cesarom.ro](http://www.cesarom.ro) website and mix the tiles to achieve the required result including turning them by 180°.

Produs / Product



60 x 30 x 0,9



EN 14411:2012, Annex G, Bla GL



7



1,26



40



50,40



23,6



brutto kg  
96

Gresie porțelanată / Porcelain tile



60 x 30



**6060-0098**  
alb/white | mat/matt PEI 4

**6060-0099**  
bej/beige | mat/matt PEI 4



**6060-0101**  
maro/brown | mat/matt PEI 4

**6060-0100**  
maro deschis/light brown | mat/matt PEI 4











# Cream





# Cream



Produs / Product								
Faiantă / Wall tile	60 x 30 x 0,9	EN 14411:2012, Annex K, BIII GL	7	1,26	40	50,40	23,6	960
Decor / Insert	60 x 30 x 0,9	EN 14411:2012, Annex K, BIII GL	6	1,08				
Brâu metalic / Metallic listel	60 x 3 x 1	EN 14411:2012, Annex G, BIIa GL	6	0,11				
Gresie porțelanată rectificată / Porcelain rectified tile	60 x 15 x 0,9	EN 14411:2012, Annex G, BIIa GL	11	0,99	48	47,52	18,7	922
Gresie porțelanată / Porcelain tile	45 x 45 x 0,9	EN 14411:2012, Annex G, BIIa GL	7	1,42	52	73,84	26,3	1395



60 x 30



V2



**2060-0114**  
bej/beige | mat/matt



**2060-0115**  
bej/beige | mat/matt



**2660-0105**  
bej/beige | mat/matt



**6606-0036** Metallic PEI 3

60 x 3



45 x 45



V2



**6046-0530**  
bej/beige | mat/matt PEI 4



**6463-0041** Legno Classico  
bej/beige | mat/matt PEI 4

60 x 15



V3



**6463-0042** Legno Classico  
maro-gri/brown-gray | mat/matt PEI 4



# Cream



## RECOMANDARE / RECOMMENDATION

Înainte de a monta plăcile, vă sugerăm să selectați din mai multe cutii, să amestecați plăcile (inclusiv prin rotirea lor cu 180°) și să le aranjați așa cum este ilustrat în fotografia de inspirație sau să consultați site-ul [www.cesarom.ro](http://www.cesarom.ro).

Before laying the tiles, we suggest you select from several boxes and arrange them as illustrated in the inspiration photo above or consult the [www.cesarom.ro](http://www.cesarom.ro) website and mix the tiles to achieve the required result including turning them by 180°.

Produs / Product	cm	EN		m <sup>2</sup>		m <sup>2</sup>	kg	brutto kg
Gresie porțelanată / Porcelain tile	60 x 30 x 0,9	EN 14411:2012, Annex G, Bla GL	7	1,26	40	50,40	23,6	960
Brâu metalic / Metallic listel	60 x 3 x 1	EN 14411:2012, Annex G, Bla GL	6	0,11				





60 x 30



V2



**6060-0195**  
bej/beige | mat/matt PEI 4



**6060-0196**  
bej/beige | mat/matt PEI 4



**6606-0036** Metalic PEI 3

60 x 3



# Granito



## RECOMANDARE / RECOMMENDATION

Înainte de a monta plăcile, vă sugerăm să selectați din mai multe cutii, să amestecați plăcile (inclusiv prin rotirea lor cu 180°) și să le aranjați așa cum este ilustrat în fotografia de inspirație sau să consultați site-ul [www.cesarom.ro](http://www.cesarom.ro).

Before laying the tiles, we suggest you select from several boxes and arrange them as illustrated in the inspiration photo above or consult the [www.cesarom.ro](http://www.cesarom.ro) website and mix the tiles to achieve the required result including turning them by 180°.

Produs / Product	 cm	 EN		 m <sup>2</sup>		 m <sup>2</sup>	 kg	 brutto kg
Gresie porțelanată / Porcelain tile	60 x 30 x 0,9	EN 14411:2012, Annex G, Bla GL	7	1,26	40	50,40	23,6	960
Gresie porțelanată / Porcelain tile	33 x 33 x 0,75	EN 14411:2012, Annex G, Bla GL	15	1,63	42	68,46	26	1120
Treaptă / Stair	60 x 30 x 0,9	EN 14411:2012, Annex G, Bla GL	6	1,08				



60 x 30



6060-0271  
gri/gray | mat/matt PEI 5

6060-0282  
maro/brown | mat/matt PEI 4

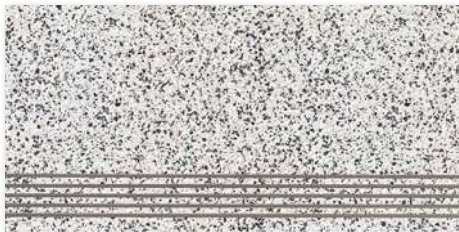

60 x 30



6806-0038  
gri/gray | mat/matt PEI 5

6806-0039  
maro/brown | mat/matt PEI 4



33 x 33



6035-0344  
gri/gray | mat/matt PEI 5

6035-0354  
maro/brown | mat/matt PEI 4

# Luberon



## RECOMANDARE / RECOMMENDATION

Înainte de a monta plăcile, vă sugerăm să selectați din mai multe cutii, să amestecați plăcile (inclusiv prin rotirea lor cu 180°) și să le aranjați așa cum este ilustrat în fotografia de inspirație sau să consultați site-ul [www.cesarom.ro](http://www.cesarom.ro).

Before laying the tiles, we suggest you select from several boxes and arrange them as illustrated in the inspiration photo above or consult the [www.cesarom.ro](http://www.cesarom.ro) website and mix the tiles to achieve the required result including turning them by 180°.

Produs / Product	cm	EN		m <sup>2</sup>		m <sup>2</sup>	kg	brutto kg
Gresie porțelanată / Porcelain tile	60 x 30 x 0,9	EN 14411:2012, Annex G, Bla GL	7	1,26	40	50,40	23,6	960
Treaptă / Stair	60 x 30 x 0,9	EN 14411:2012, Annex G, Bla GL	6	1,08				



60 x 30



6060-0249  
bej/beige | mat/matt PEI 4



60 x 30



6806-0039  
maro/brown | mat/matt PEI 4



60 x 30



6460-0270 Tanum  
antraci/anthracite | mat/matt PEI 4



# River Stones



## RECOMANDARE / RECOMMENDATION

Înainte de a monta plăcile, vă sugerăm să selectați din mai multe cutii, să amestecați plăcile (inclusiv prin rotirea lor cu 180°) și să le aranjați așa cum este ilustrat în fotografia de inspirație sau să consultați site-ul [www.cesarom.ro](http://www.cesarom.ro).

Before laying the tiles, we suggest you select from several boxes and arrange them as illustrated in the inspiration photo above or consult the [www.cesarom.ro](http://www.cesarom.ro) website and mix the tiles to achieve the required result including turning them by 180°.

Produs / Product





60 x 30



**6060-0254**  
maro/brown | mat/matt PEI 5



# Terrazzino



## RECOMANDARE / RECOMMENDATION

Înainte de a monta plăcile, vă sugerăm să selectați din mai multe cutii, să amestecați plăcile (inclusiv prin rotirea lor cu 180°) și să le aranjați așa cum este ilustrat în fotografia de inspirație sau să consultați site-ul [www.cesarom.ro](http://www.cesarom.ro).

Before laying the tiles, we suggest you select from several boxes and arrange them as illustrated in the inspiration photo above or consult the [www.cesarom.ro](http://www.cesarom.ro) website and mix the tiles to achieve the required result including turning them by 180°.

Produs / Product



60 x 30 x 0,9



EN 14411:2012, Annex G, Bla GL



7



1,26



40



50,40



23,6



960





60 x 30











V2



6060-0356  
multicolor/multicolour | mat/matt PEI 4

# City



Produs / Product								
Faianță rectificată / Rectified tile	60 x 30 x 1,0	EN 14411:2012, Annex K, BIII GL	6	1,08	40	43,20	20	825
Gresie porțelanată   Porcelain tile	60x60x1,0	EN 14411:2016, annex G BIIa GL	3	1,08	32	34,56	23,7	782
Gresie porțelanată rectificată / Porcelain rectified tile	60 x 15 x 0,9	EN 14411:2012, Annex G, BIIa GL	11	0,99	48	47,52	18,7	922
Brâu / Listel	60 x 3 x 1	EN 14411:2012, Annex G, BIIa GL	6	0,11				



**1260-0082**  
gri deschis/light gray | mat/matt



60 x 30



60 x 30



**1260-0083**  
gri/gray | mat/matt



**6606-0036 Metallic PEI 3**

60 x 3



60 x 60



**6461-0237 / DAK 63792 Betonico**  
negru/black | mat/matt PEI 4



**6463-0032 Pavimento**  
maro/brown | mat/matt PEI 4

60 x 15



# Concepto





# Concepto

90 x 30



V1

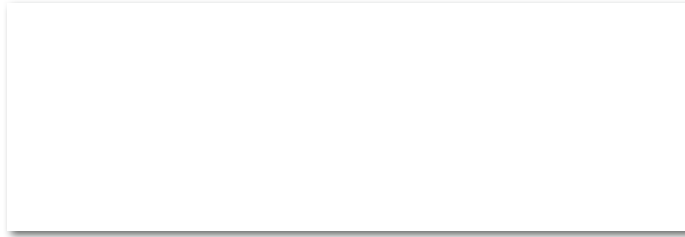

**1296-0014**  
alb/white | lucios/glossy



**1296-0015**  
alb/white | lucios/glossy

60 x 30



V3



**6460-0279 Essential**  
gri/gray | mat-lucios/matt-glossy PEI 4

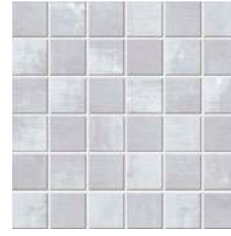

30 x 30



V3



**6100-0093 Essential**  
gri/gray | mat-lucios/matt-glossy  
SET = 1 folie PEI 4



**6460-0297 Breccia**  
gri/gray | mat/matt PEI 4

60 x 60



V4



**6461-0163 / DAK63433 Base**  
negru/black | mat/matt PEI 4

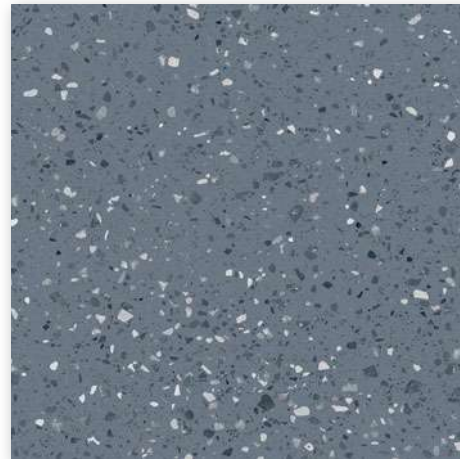

**6461-0261 / DAS63815 Porfido**  
albastru/blue | mat-lucios/matt-glossy PEI 4

60 x 60



V3



R10

Produs / Product



EN



m<sup>2</sup>



m<sup>2</sup>

kg

brutto kg

Faianță rectificată / Rectified tile

90 x 30 x 1,0

EN 14411:2012, Annex K, BIII GL

4

1,08

30

32,40

20

625

Gresie porțelanată rectificată / Rectified porcelain tile

60 x 60 x 1,0

EN 14411:2016, Annex G Bla GL

3

1,08

32

34,56

21,9

782

Gresie porțelanată rectificată / Rectified porcelain tile

60 x 30 x 0,9

EN 14411:2012, Annex G, Bla GL

7

1,26

40

50,40

23,6

960

Mozaic porțelanat / Porcelain mosaic

30 x 30 x 0,9

A.T. nr. 003-04/484-2021

4 SET

0,36



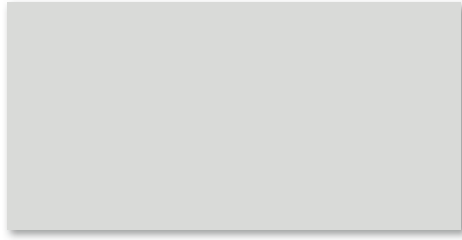

1260-0077  
gri/gray | lucios/glossy

1260-0183

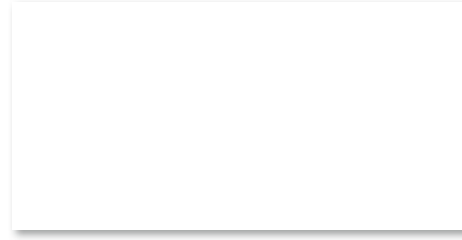

1260-0075  
alb/white | lucios/glossy

1260-0181



60 x 30



V1



1260-0076  
alb/white | lucios/glossy

1260-0182



6606-0036 Metallic PEI 3

60 x 3



6460-0302 Ceppo di Gre  
gri/gray | mat/matt PEI 4

60 x 30



V3



R10



6060-0356 Terrazzino  
multicolor/multicolour | mat/matt PEI 4

60 x 30



V2

30 x 30



V2

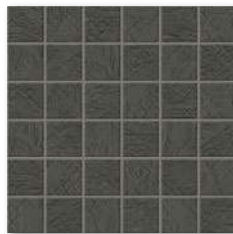

6100-0092 Move  
antracit/anthracite | mat/matt  
SET = 1 folie PEI 3



6460-0277 Move  
antracit/anthracite | mat/matt PEI 3

60 x 30



V2



Produs / Product



EN



Produs / Product	cm	EN	Hand icon	m²	Hand icon	m²	kg	brutto kg
Faianță rectificată / Rectified tile	60 x 30 x 1,0	EN 14411:2012, Annex K, BIII GL	6	1,08	40	43,20	20	825
Faianță rectificată / Rectified tile	60 x 30 x 0,8	EN 14411:2012, Annex K, BIII GL	8	1,44	40	57,60	21,3	876
Gresie porțelanată rectificată / Rectified porcelain tile	60 x 30 x 0,9	EN 14411:2012, Annex G, BIIa GL	7	1,26	40	50,40	23,6	960
Brâu metalic / Metallic listel	60 x 3 x 1	EN 14411:2012, Annex G, BIIa GL	6	0,11				
Mozaic porțelanat / Porcelain mosaic	30 x 30 x 0,9	A.T. nr. 003-04/484-2021	4 SET	0,36				

activează



10  
an  
garanție  
și manopera  
înapoi.

# Trendy



## Produs / Product

	 cm	 EN		 m <sup>2</sup>		 m <sup>2</sup>	 kg	 brutto kg
Faianță rectificată / Rectified tile	60 x 30 x 0,8	EN 14411-2012, Annex K, BIII GL	8	1,44	40	57,60	21,3	876
Gresie porțelanată rectificată / Porcelain rectified tile	60 x 15 x 0,9	EN 14411-2012, Annex G, BIa GL	11	0,99	48	47,52	18,7	922
Mozaic/Mosaic	30 x 30 x 0,8	A.T. nr. 003-04/485-2022	4 SET	0,36				



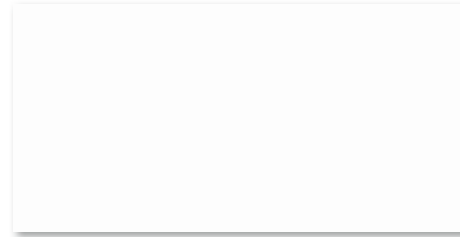

60 x 30



V1



**1260-0105**  
ivoriu/ivory | mat/matt



60 x 30



V2



**1260-0104**  
multicolor/multicolour | mat/matt

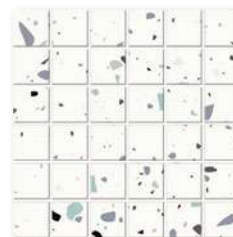

30 x 30



V2



**1600-0060**  
multicolor/multicolour | mat/matt  
SET = 1 folie PEI 4



60 x 15



V3





**6463-0037 Rovere**  
maro/brown | mat/matt PEI 4



# Venice



Produs / Product	cm	EN		m <sup>2</sup>		m <sup>2</sup>	kg	brutto kg
Faianță rectificată / Rectified tile	60 x 30 x 1,0	EN 14411:2012, Annex K, BIII GL	6	1,08	40	43,20	20	825
Gresie porțelanată rectificată / Porcelain rectified tile	60 x 15 x 0,9	EN 14411:2012, Annex G, Bla GL	11	0,99	48	47,52	18,7	922
Brâu / Listel	60 x 3 x 1,0	EN 14411:2012, Annex G, Bla GL	6	0,11				
Mozaic / Mosaic	30 x 30 x 0,9	A.T. nr. 003-04/485-2022	4 SET	0,36				



60 x 30



V3



1260-0078  
alb/white | lucios/glossy



1260-0079  
alb/white | lucios/glossy



6606-0036 Metallic PEI 3

60 x 3



1600-0059  
alb/white | lucios/glossy  
SET = 1 folie

30 x 30



V3



60 x 15



V3



6463-0042 Legno Classico  
maro-gri/brown-gray | mat/matt PEI 4



# Concrete



## RECOMANDARE / RECOMMENDATION

Înainte de a monta plăcile, vă sugerăm să selectați din mai multe cutii, să amestecați plăcile (inclusiv prin rotirea lor cu 180°) și să le aranjați așa cum este ilustrat în fotografia de inspirație sau să consultați site-ul [www.cesarom.ro](http://www.cesarom.ro).

Before laying the tiles, we suggest you select from several boxes and arrange them as illustrated in the inspiration photo above or consult the [www.cesarom.ro](http://www.cesarom.ro) website and mix the tiles to achieve the required result including turning them by 180°.

Produs / Product	cm	EN		m <sup>2</sup>		m <sup>2</sup>	kg	brutto kg
Faianță / Wall tile	60 x 30 x 0,9	EN 14411:2012, Annex K, BIII GL	7	1,26	40	50,40	23,6	960
Gresie porțelanată / Porcelain tile	45 x 45 x 0,9	EN 14411:2012, Annex G, Bla GL	7	1,42	52	73,84	26,3	1395



**2060-0119**  
gri/gray | mat/matt



60 x 30



V2



**2060-0120**  
gri/gray | mat/matt



**2060-0128**  
multicolor/multicolour | mat/matt



**2060-0127**  
multicolor/multicolour | mat/matt

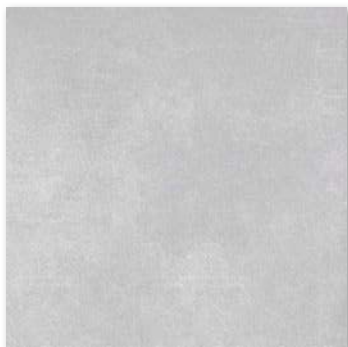

**6046-0529**  
gri/gray | mat/matt PEI 4

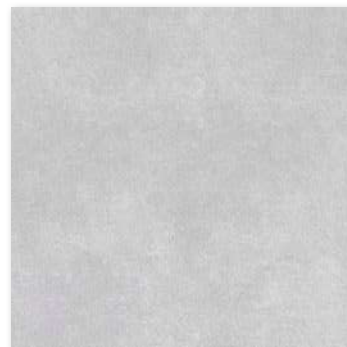





45 x 45



V2





Produs / Product	cm	EN						kg	brutto kg
Faianță / Wall tile	60 x 30 x 0,9	EN 14411:2012, Annex K, BIII GL	7	1,26	40	50,40	23,6	960	
Gresie porțelanată rectificată / Porcelain rectified tile	60 x 15 x 0,9	EN 14411:2012, Annex G, BIIa GL	11	0,99	48	47,52	18,7	922	
Gresie porțelanată / Porcelain tile	45 x 45 x 0,9	EN 14411:2012, Annex G, BIIa GL	7	1,42	52	73,84	26,3	1395	
Decor / Insert	60 x 30 x 0,9	EN 14411:2012, Annex K, BIII GL	6	1,08					



60 x 30



V2



**2060-0136**  
alb/white | lucios/glossy



**2060-0135 Pulpis**  
alb-gri/white-gray | lucios/glossy



**2660-0115**  
aur/gold | lucios/glossy

45 x 45



V2



**4046-0132 Calacatta Oro**  
alb/white | lucios/glossy PEI 3



60 x 15



V3



**6463-0037 Rovere**  
maro/brown | mat/matt PEI 4



# Firenze

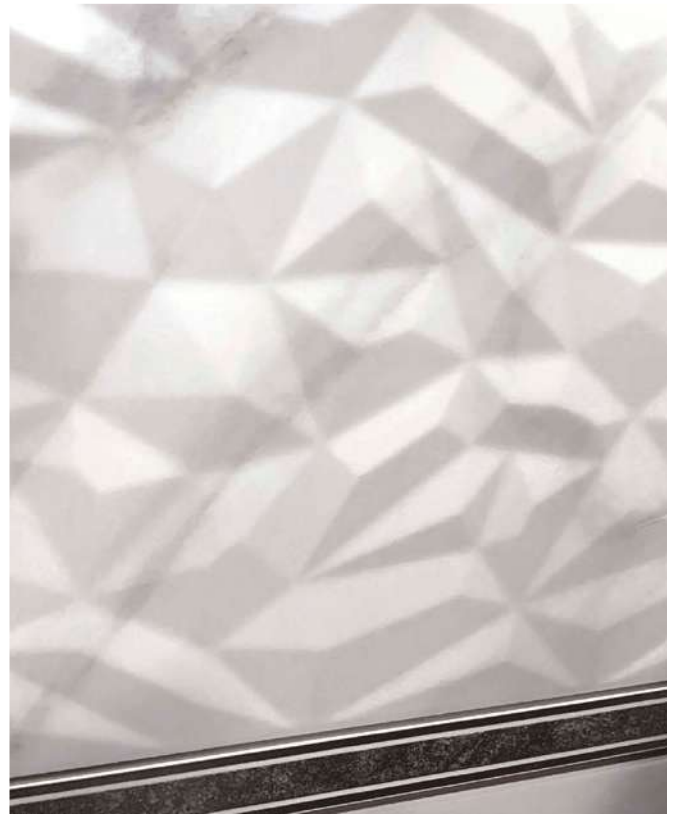

Produs / Product	cm	EN		m <sup>2</sup>		m <sup>2</sup>	kg	brutto kg
Faianță / Wall tile	60 x 30 x 0,9	EN 14411:2012, Annex K, BIII GL	7	1,26	40	50,40	23,6	960
Brău metalic / Metallic listel	60 x 3 x 1	EN 14411:2012, Annex G, BIIa GL	6	0,11				
Gresie / Floor tile	45 x 45 x 0,9	EN 14411:2012, Annex K, BIII GL	7	1,42	52	73,84	23,7	1257





60 x 30



V3



**2060-0105**  
alb/white | mat/matt



**2060-0106**  
alb/white | mat/matt



**2060-0133 Unique**  
bej/beige | mat/matt



**6606-0036 Metallic PEI 3**

60 x 3



45 x 45



V3

**4046-0118**  
alb/white | mat/matt PEI 3





# Mirage



## RECOMANDARE / RECOMMENDATION

Înainte de a monta plăcile, vă sugerăm să selectați din mai multe cutii, să amestecați plăcile (inclusiv prin rotirea lor cu 180°) și să le aranjați așa cum este ilustrat în fotografia de inspirație sau să consultați site-ul [www.cesarom.ro](http://www.cesarom.ro).

Before laying the tiles, we suggest you select from several boxes and arrange them as illustrated in the inspiration photo above or consult the [www.cesarom.ro](http://www.cesarom.ro) website and mix the tiles to achieve the required result including turning them by 180°.

Produs / Product	cm	EN		m <sup>2</sup>		m <sup>2</sup>	kg	brutto kg
Faianță / Wall tile	60 x 30 x 0,9	EN 14411:2012, Annex K, BIII GL	7	1,26	40	50,40	23,6	960
Gresie porțelanată rectificată / Porcelain rectified tile	60 x 15 x 0,9	EN 14411:2012, Annex G, Bla GL	11	0,99	48	47,52	18,7	922
Gresie / Floor tile	45 x 45 x 0,9	EN 14411:2012, Annex K, BIII GL	7	1,42	52	73,84	23,7	1257
Decor / Insert	60 x 30 x 0,9	EN 14411:2012, Annex K, BIII GL	6	1,08				



60 x 30



**2060-0131**  
gri/gray | lucios/glossy



**2060-0113**  
gri/gray | lucios/glossy



60 x 30



**2060-0133 Unique**  
bej/beige | mat/matt



45 x 45



**4046-0125**  
gri/gray | lucios/glossy PEI 3



60 x 15











**6463-0031 Pavimento**  
bej/beige | mat/matt PEI 4



# Perfect



Produs / Product	 cm	 EN		 m <sup>2</sup>		 m <sup>2</sup>	 kg	 brutto kg
Faianță / Wall tile	60 x 30 x 0,9	EN 14411:2012, Annex K, BIII GL	7	1,26	40	50,40	23,6	960
Gresie porțelanată rectificată / Porcelain rectified tile	60 x 15 x 0,9	EN 14411:2012, Annex G, BIIa GL	11	0,99	48	47,52	18,7	922
Gresie / Floor tile	45 x 45 x 0,9	EN 14411:2012, Annex K, BIII GL	7	1,42	52	73,84	23,7	1257
Decor / Insert	60 x 30 x 0,9	EN 14411:2012, Annex K, BIII GL	6	1,08				



60 x 30



V3



**2060-0132**  
alb/white | lucios/glossy



**2660-0112**  
alb/white | lucios/glossy



**2060-0133 Unique**  
bej/beige | mat/matt



**4046-0137**  
alb/white | lucios/glossy PEI 3

45 x 45



V3



60 x 15



V4



**6463-0031 Pavimento**  
bej/beige | mat/matt PEI 4





Produs / Product



Faianță / Wall tile

60 x 30 x 0,9

EN 14411:2012, Annex K, BIII GL

7

1,26

40

50,40

23,6

960

Gresie porțelanată rectificată / Porcelain rectified tile

60 x 15 x 0,9

EN 14411:2012, Annex G, BIIa GL

11

0,99

48

47,52

18,7

922

Gresie porțelanată / Porcelain tile

45 x 45 x 0,9

EN 14411:2012, Annex G, BIIa GL

7

1,42

52

73,84

26,3

1395



60 x 30



V2



**2060-0134**  
gri/gray | lucios/glossy



**2060-0135**  
alb-gri/white-gray | lucios/glossy



45 x 45



V2

**4046-0138**  
gri/gray | mat/matt PEI 3



60 x 15



V3



**6463-0053 Legno Miele**  
bej/beige | mat/matt PEI 4



activează



**10**  
an  
garanție  
și manopera  
înapoi.

# Purity



Produs / Product	cm	EN		m <sup>2</sup>		m <sup>2</sup>	kg	brutto kg
Faianță / Wall tile	60 x 30 x 0,9	EN 14411:2012, Annex K, BIII GL	7	1,26	40	50,40	23,6	960
Decor / Insert	60 x 30 x 0,9	EN 14411:2012, Annex K, BIII GL	6	1,08				
Gresie / Floor tile	45 x 45 x 0,9	EN 14411:2012, Annex K, BIII GL	7	1,42	52	73,84	23,7	1257





60 x 30



V3



**2060-0116**  
bej/beige | lucios/glossy



**2660-0111**  
aur/gold | lucios/glossy



45 x 45



V3

**4046-0119**  
bej/beige | lucios/glossy PEI 3



# Unique



Produs / Product



60 x 30 x 0,9  
60 x 30 x 0,9



EN 14411:2012, Annex K, BIII GL  
EN 14411:2012, Annex K, BIII GL



7  
6



1,26  
1,08



40



50,40



23,6



960



60 x 30



V1

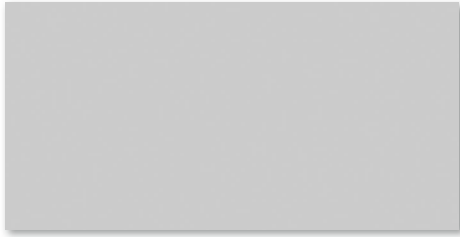

**2060-0103**  
gri/gray | lucios/glossy

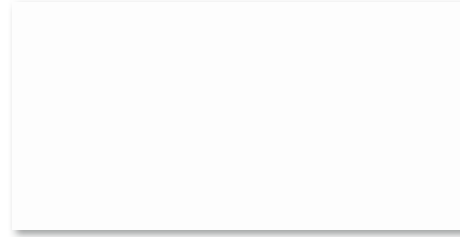

**2060-0101**  
alb/white | lucios/glossy



**2060-0123**  
gri/gray | lucios/glossy



**2060-0121**  
alb/white | lucios/glossy



**2660-0114**  
gri/gray | mat-lucios/matt-glossy

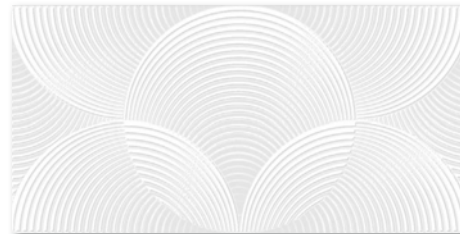

**2060-0108**  
alb/white | lucios/glossy

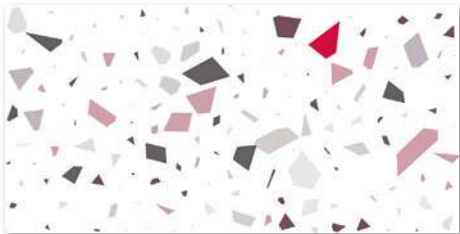

**2060-0130**  
multicolor/multicolour | lucios/glossy

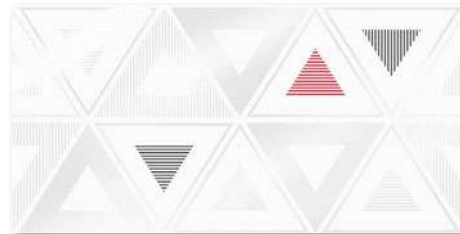

**2660-0109**  
multicolor/multicolour | lucios/glossy



**2060-0133**  
bej/beige | mat/matt



60 x 30



V3



# Unique



Produs / Product



Faianță / Wall tile

60 x 30 x 0,9

EN 14411:2012, Annex K, BIII GL

7

1,26

40

50,40

23,6

960

Decor / Insert

60 x 30 x 0,9

EN 14411:2012, Annex K, BIII GL

6

1,08



60 x 30



V1

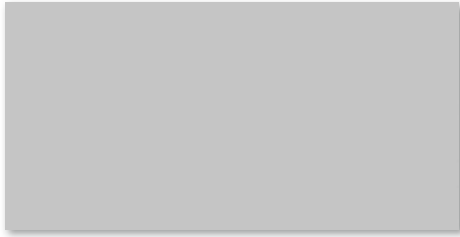

**2060-0104**  
gri/gray | mat/matt

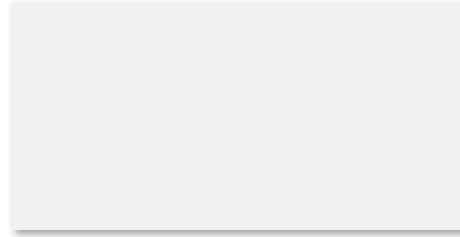

**2060-0102**  
alb/white | mat/matt



**2060-0124**  
gri/gray | mat/matt



**2060-0117**  
alb/white | mat/matt



**2060-0125**  
alb/white | mat/matt



**2060-0122**  
alb/white | mat/matt



**2660-0114**  
gri/gray | mat-lucios/matt-glossy



**2060-0133**  
bej/beige | mat/matt



60 x 30





V3



# White Project



Produs / Product	cm	EN		m <sup>2</sup>		m <sup>2</sup>	kg	brutto kg
Faianță / Wall tile	60 x 30 x 0,9	EN 14411:2012, Annex K, BIII GL	7	1,26	40	50,40	20,5	845
Faianță / Wall tile	50 x 25 x 0,9	EN 14411:2012, Annex K, BIII GL	11	1,38	45	62,10	21,0	970
Faianță / Wall tile	40,2 x 25,2 x 0,8	EN 14411:2012, Annex K, BIII GL	15	1,52	54	82,08	21,0	1160
Faianță / Wall tile	40,2 x 20,2 x 0,75	EN 14411:2012, Annex K, BIII GL	16	1,30	54	70,20	15,5	865

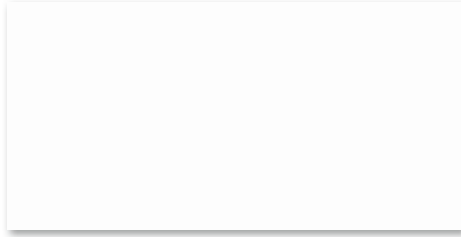

**2060-0101 Unique**  
alb/white | lucios/glossy

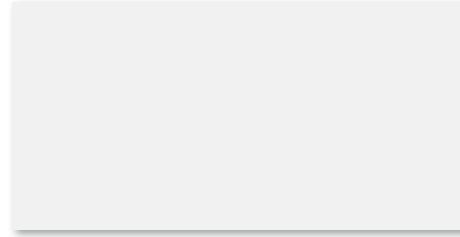

**2060-0102 Unique**  
alb/white | mat/matt

60 x 30



V1



**2060-0122 Unique**  
alb/white | mat/matt

**2060-0121**  
alb/white | lucios/glossy



**2060-0117 Unique**  
alb/white | mat/matt

**2060-0108**  
alb/white | lucios/glossy

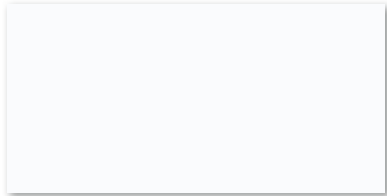

**2051-0152 Cromatic Gloss**  
alb/white | lucios/glossy

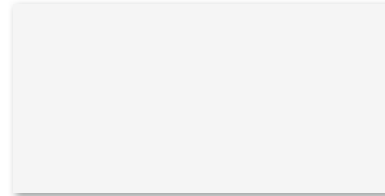

**2051-0153 ColorLine**  
alb/white | mat/matt

50 x 25



V1



**2051-0210 Cromatic Gloss**  
alb/white | lucios/glossy



**2051-0154 ColorLine**  
alb/white | mat/matt

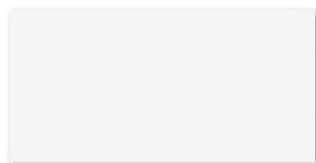

**2041-0061 Project**  
alb/white | mat/matt

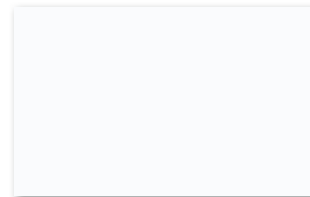

**2042-0068 Cromatic**  
alb/white | lucios/glossy

40,2 x 25,2



V1

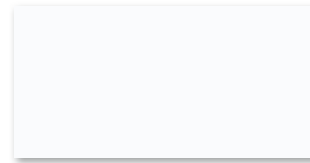

**2041-0086 E-Project**  
alb/white | lucios/glossy

40,2 x 20,2



V1



**2041-0138 E-Project**  
alb/white | lucios/glossy

# Annex

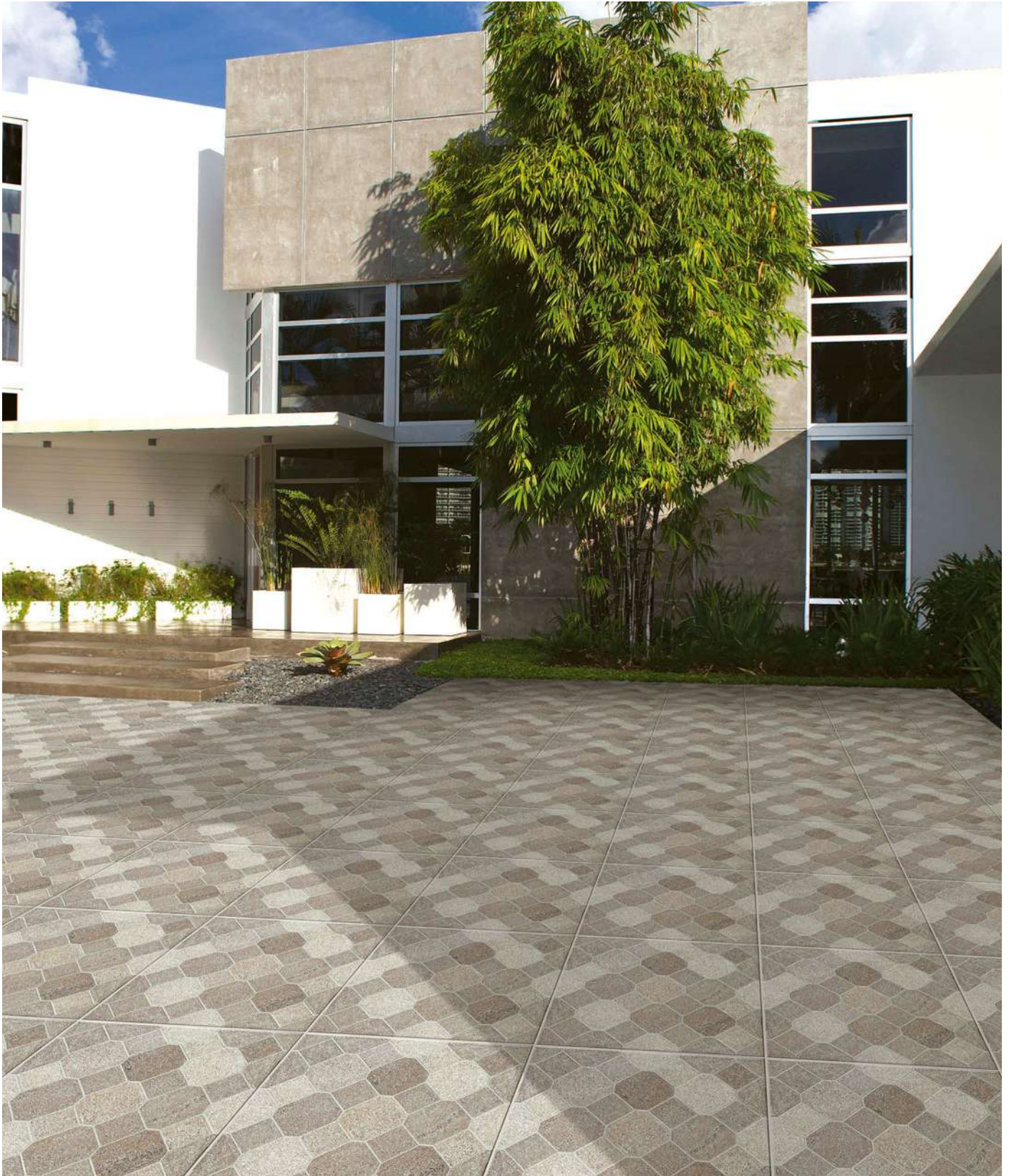

Produs / Product



Gresie porțelanată / Porcelain tile

45 x 45 x 0,9

EN 14411:2012, Annex G, Bla GL

7

1,42

52

73,84

26,3

1395





45 x 45



V3



**6046-0140**  
gri/gray | mat/matt PEI 4

**RECOMANDARE / RECOMMENDATION**

Înainte de a monta plăcile, vă sugerăm să selectați din mai multe cutii, să amestecați plăcile (inclusiv prin rotirea lor cu 180°) și să le aranjați așa cum este ilustrat în fotografia de inspirație sau să consultați site-ul [www.cesarom.ro](http://www.cesarom.ro).

Before laying the tiles, we suggest you select from several boxes and arrange them as illustrated in the inspiration photo above or consult the [www.cesarom.ro](http://www.cesarom.ro) website and mix the tiles to achieve the required result including turning them by 180°.



# Beauty



# Ceppo



Prodotto / Product



45 x 45 x 0,9



EN 14411-2:2012, Annex K, BIII GL



7



1,42



52



73,84



23,7



brutto kg  
1257



45 x 45



V4



**4046-0136**  
gri/gray | lucios/glossy PEI 3



45 x 45



V4



**4046-0126**  
gri/gray | lucios/glossy PEI 3

**RECOMANDARE / RECOMMENDATION**

Înainte de a monta plăcile, vă sugerăm să selectați din mai multe cutii, să amestecați plăcile (inclusiv prin rotirea lor cu 180°) și să le aranjați așa cum este ilustrat în fotografia de inspirație sau să consultați site-ul [www.cesarom.ro](http://www.cesarom.ro).

Before laying the tiles, we suggest you select from several boxes and arrange them as illustrated in the inspiration photo above or consult the [www.cesarom.ro](http://www.cesarom.ro) website and mix the tiles to achieve the required result including turning them by 180°.

# Decora



Produs / Product



EN



m<sup>2</sup>



m<sup>2</sup>

kg

brutto kg

Gresie porțelanată / Porcelain tile

45 x 45 x 0,9

EN 14411:2012, Annex G, Bla GL

7

1,42

52

73,84

26,3

1395

Gresie porțelanată / Porcelain tile

33 x 33 x 0,75

EN 14411:2012, Annex G, Bla GL

15

1,63

42

68,46

26

1120



**CESAROM®**

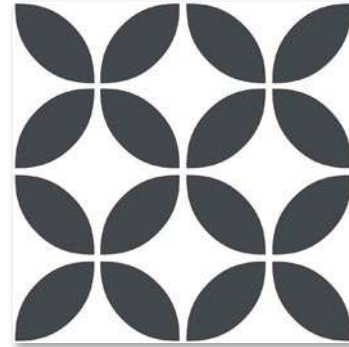

6046-0522  
alb-gri/white-gray | mat/matt PEI 4

45 x 45



6035-0361  
gri/gray | mat/matt PEI 5

33 x 33



#### RECOMANDARE / RECOMMENDATION

Înainte de a monta plăcile, vă sugerăm să selectați din mai multe cutii, să amestecați plăcile (inclusiv prin rotirea lor cu 180°) și să le aranjați așa cum este ilustrat în fotografia de inspirație sau să consultați site-ul [www.cesarom.ro](http://www.cesarom.ro).

Before laying the tiles, we suggest you select from several boxes and arrange them as illustrated in the inspiration photo above or consult the [www.cesarom.ro](http://www.cesarom.ro) website and mix the tiles to achieve the required result including turning them by 180°.



## Flakes



## Gardena



Produs / Product



45 x 45 x 0,9



EN 14411:2012, Annex G, Bla GL



7



1,42



52



73,84



26,3



1395



45 x 45

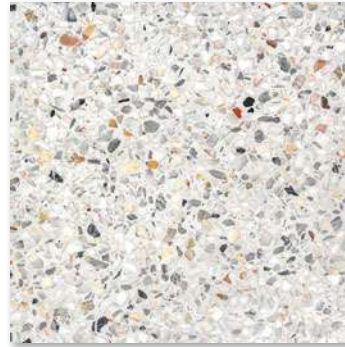

**6046-0439**  
multicolor/ multicolour | mat/matt PEI 5



45 x 45



**6046-0517**  
bej/beige | mat/matt PEI 5

**RECOMANDARE / RECOMMENDATION**

Înainte de a monta plăcile, vă sugerăm să selectați din mai multe cutii, să amestecați plăcile (inclusiv prin rotirea lor cu 180°) și să le aranjați așa cum este ilustrat în fotografia de inspirație sau să consultați site-ul [www.cesarom.ro](http://www.cesarom.ro).

Before laying the tiles, we suggest you select from several boxes and arrange them as illustrated in the inspiration photo above or consult the [www.cesarom.ro](http://www.cesarom.ro) website and mix the tiles to achieve the required result including turning them by 180°.



# Karo



# King



Prods / Product



45 x 45 x 0,9



EN 14411:2012, Annex K, Billi GL



7



1,42



52



73,84



23,7



brutto kg  
1257





**4046-0128 Karo**  
maro/brown | lucios/glossy PEI 3



45 x 45



V4



**4046-0130 King**  
maro/brown | lucios/glossy PEI 3



**4046-0129 King**  
gri/gray | lucios/glossy PEI 3

45 x 45



V4

**RECOMANDARE / RECOMMENDATION**

Înainte de a monta plăcile, vă sugerăm să selectați din mai multe cutii, să amestecați plăcile (inclusiv prin rotirea lor cu 180°) și să le aranjați așa cum este ilustrat în fotografia de inspirație sau să consultați site-ul [www.cesarom.ro](http://www.cesarom.ro).

Before laying the tiles, we suggest you select from several boxes and arrange them as illustrated in the inspiration photo above or consult the [www.cesarom.ro](http://www.cesarom.ro) website and mix the tiles to achieve the required result including turning them by 180°.

# Limestone



# Living

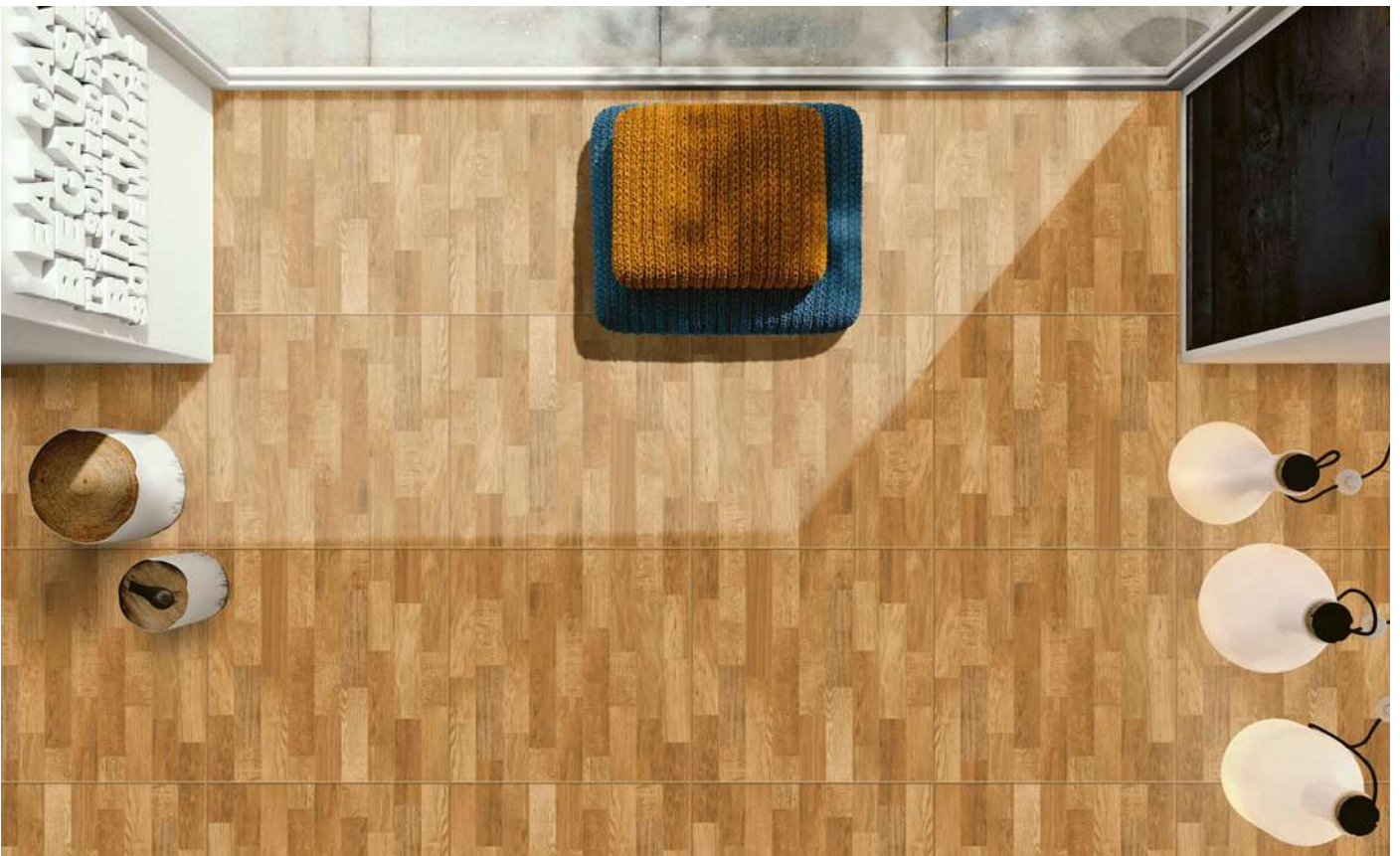

Prodotto / Product



45 x 45 x 0,9



EN 14411-2:2012, Annex K, BIII GL



7



1,42



52



73,84



23,7



1257



45 x 45



V4



**4046-0127**  
bej/beige | lucios/glossy PEI 3



45 x 45



V4

**4046-0122 Living**  
maro/brown | mat/matt PEI 3

**RECOMANDARE / RECOMMENDATION**

Înainte de a monta plăcile, vă sugerăm să selectați din mai multe cutii, să amestecați plăcile (inclusiv prin rotirea lor cu 180°) și să le aranjați așa cum este ilustrat în fotografia de inspirație sau să consultați site-ul [www.cesarom.ro](http://www.cesarom.ro).

Before laying the tiles, we suggest you select from several boxes and arrange them as illustrated in the inspiration photo above or consult the [www.cesarom.ro](http://www.cesarom.ro) website and mix the tiles to achieve the required result including turning them by 180°.



#### RECOMANDARE / RECOMMENDATION

Înainte de a monta plăcile, vă sugerăm să selectați din mai multe cutii, să amestecați plăcile (inclusiv prin rotirea lor cu 180°) și să le aranjați așa cum este ilustrat în fotografia de inspirație sau să consultați site-ul [www.cesarom.ro](http://www.cesarom.ro).

Before laying the tiles, we suggest you select from several boxes and arrange them as illustrated in the inspiration photo above or consult the [www.cesarom.ro](http://www.cesarom.ro) website and mix the tiles to achieve the required result including turning them by 180°.

Produs / Product



45 x 45 x 0,9



EN 14411-2012, Annex G, Bla GL



7



1,42



52



73,84



26,3



1395



45 x 45



**6046-0534**  
maro/brown | mat/matt PEI 4



# Mayenne



# Natura



Produs / Product



45 x 45 x 0,9



EN 14411-2012, Annex G, Bla GL



7



1,42



52



73,84



26,3



1395



45 x 45



**6046-0367**  
bej/beige | mat/matt PEI 5

**6046-0368**  
gri/gray | mat/matt PEI 5



45 x 45



**6046-0450 Natura**  
bej/beige | mat/matt PEI 4

**6046-0451 Natura**  
gri/greie | mat/matt PEI 4

**RECOMANDARE / RECOMMENDATION**

Înainte de a monta plăcile, vă sugerăm să selectați din mai multe cutii, să amestecați plăcile (inclusiv prin rotirea lor cu 180°) și să le aranjați așa cum este ilustrat în fotografia de inspirație sau să consultați site-ul [www.cesarom.ro](http://www.cesarom.ro).

Before laying the tiles, we suggest you select from several boxes and arrange them as illustrated in the inspiration photo above or consult the [www.cesarom.ro](http://www.cesarom.ro) website and mix the tiles to achieve the required result including turning them by 180°.



# Norway



# Terra



Produs / Product



45 x 45 x 0,9



EN 14411-2:2012, Annex G, Bla GL



7



1,42



52



73,84



26,3



1395





45 x 45



**6046-0137 Norway**  
maro/brown | mat/matt PEI 4



45 x 45



**6046-0518**  
multicolor/multicolour | mat/matt PEI 4

**RECOMANDARE / RECOMMENDATION**

Înainte de a monta plăcile, vă sugerăm să selectați din mai multe cutii, să amestecați plăcile (inclusiv prin rotirea lor cu 180°) și să le aranjați așa cum este ilustrat în fotografia de inspirație sau să consultați site-ul [www.cesarom.ro](http://www.cesarom.ro).

Before laying the tiles, we suggest you select from several boxes and arrange them as illustrated in the inspiration photo above or consult the [www.cesarom.ro](http://www.cesarom.ro) website and mix the tiles to achieve the required result including turning them by 180°.



# Yard

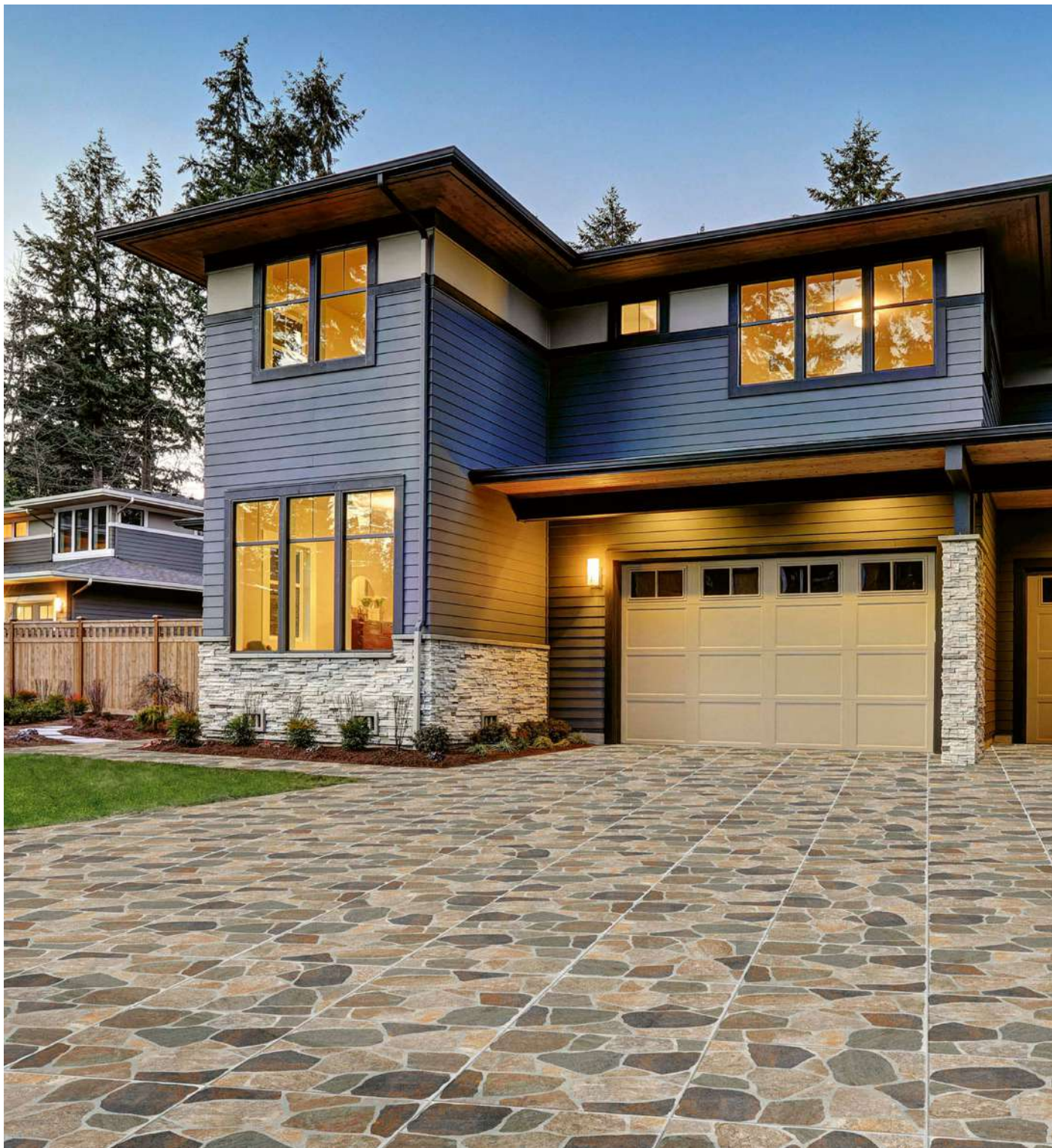

## RECOMANDARE / RECOMMENDATION

Înainte de a monta plăcile, vă sugerăm să selectați din mai multe cutii, să amestecați plăcile (inclusiv prin rotirea lor cu 180°) și să le aranjați așa cum este ilustrat în fotografia de inspirație sau să consultați site-ul [www.cesarom.ro](http://www.cesarom.ro).

Before laying the tiles, we suggest you select from several boxes and arrange them as illustrated in the inspiration photo above or consult the [www.cesarom.ro](http://www.cesarom.ro) website and mix the tiles to achieve the required result including turning them by 180°.

Produs / Product





45 x 45



**6046-0438**  
multicolor/multicolour | mat/matt PEI 4



# Ara



produs / product								
Faianță / Wall tile	50 x 25 x 0,9	EN 14411:2012, Annex K, BIII GL	11	1,38	45	62,10	21,0	970
Decor / Insert	50 x 25 x 0,9	EN 14411:2012, Annex K, BIII GL	10	1,25				
Brâu / Listel	50 x 2,5 x 0,9	EN 14411:2012, Annex K, BIII GL	20	0,25				
Gresie / Floor tile	33 x 33 x 0,8	EN 14411:2012, Annex K, BIII GL	15	1,63	42	68,46	24,0	1035

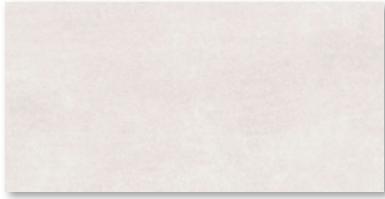

**2051-0179**  
ivoriu/ivory | lucios/glossy

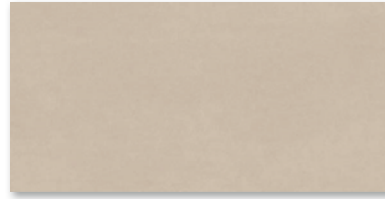
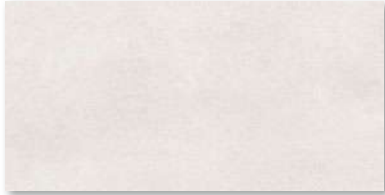

**2051-0180**  
bej închis/dark beige | lucios/glossy

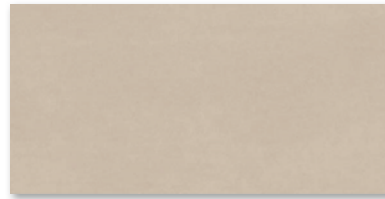
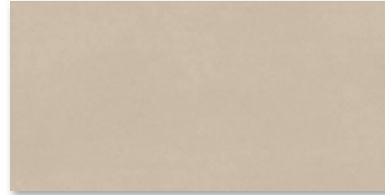

50 x 25



V2



**2051-0188**  
ivoriu/ivory | lucios/glossy



**2051-0187**  
ivoriu/ivory | lucios/glossy

SL



**2651-0092**  
ivoriu/ivory | lucios/glossy



**2651-0093**  
ivoriu/ivory | lucios/glossy



**2505-0120**  
auriu/gold | lucios/glossy



**2505-0123 Luster**  
bej închis/dark beige | lucios/glossy

50 x 2,5

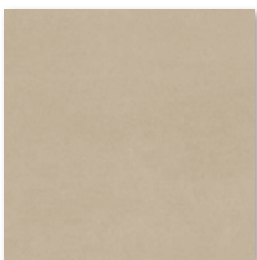

**4035-0230**  
bej închis/dark beige | lucios/glossy PEI 3



33 x 33





V2



# ColorLine



Produs / Product	cm	EN		m <sup>2</sup>		m <sup>2</sup>	kg	brutto kg
Faianță / Wall tile	50 x 25 x 0,9	EN 14411:2012, Annex K, BIII GL	11	1,38	45	62,10	21,0	970
Decor / Insert	50 x 25 x 0,9	EN 14411:2012, Annex K, BIII GL	10	1,25				
Brâu / Listel	50 x 4,75 x 0,9	EN 14411:2012, Annex K, BIII GL	20	0,48				
Brâu / Listel	50 x 2,5 x 0,9	EN 14411:2012, Annex K, BIII GL	20	0,25				
Gresie porțelanată rectificată / Porcelain rectified tile	60 x 15 x 0,9	EN 14411:2012, Annex G, Bla GL	11	0,99	48	47,52	18,7	922
Gresie / Floor tile	33 x 33 x 0,8	EN 14411:2012, Annex K, BIII GL	15	1,63	42	68,46	24,0	1035



50 x 25

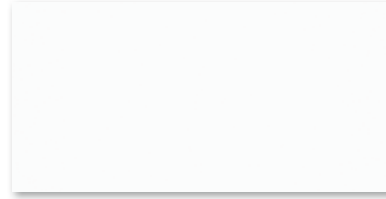

**2051-0153**  
alb/white | mat/matt

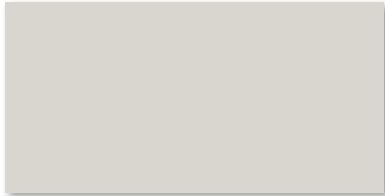

**2051-0200**  
gri deschis/light gray | mat/matt



**2051-0157**  
navy/navy | mat/matt

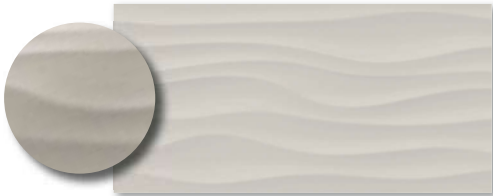

**2051-0201**  
gri deschis/light gray | mat/matt



**2051-0154**  
alb/white | mat/matt



**2651-0097**  
gri/gray | mat/matt



**2051-0169**  
multicolor/multicolour | mat/matt



**2505-0121 Platină**  
platină/platinum | lucios/glossy



**2505-0111**  
navy/navy | mat/matt

50 x 2.5  
50 x 4.75



60 x 15



**6463-0042 Legno Classico**  
maro-gri/brown-gray | mat/matt PEI 4

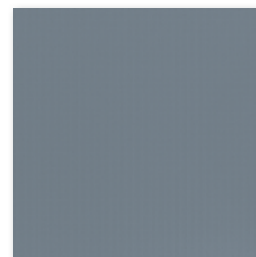

**4035-0236**  
navy/navy | mat/matt PEI 2

33 x 33





## RECOMANDARE / RECOMMENDATION

Înainte de a monta plăcile, vă sugerăm să selectați din mai multe cutii, să amestecați plăcile (inclusiv prin rotirea lor cu 180°) și să le aranjați așa cum este ilustrat în fotografia de inspirație sau să consultați site-ul [www.cesarom.ro](http://www.cesarom.ro).

Before laying the tiles, we suggest you select from several boxes and arrange them as illustrated in the inspiration photo above or consult the [www.cesarom.ro](http://www.cesarom.ro) website and mix the tiles to achieve the required result including turning them by 180°.

produs / product	cm	EN		m <sup>2</sup>		m <sup>2</sup>	kg	brutto kg
Faianță / Wall tile	50 x 25 x 0,9	EN 14411:2012, Annex K, BIII GL	11	1,38	45	62,10	21,0	970
Decor / Insert	50 x 25 x 0,9	EN 14411:2012, Annex K, BIII GL	10	1,25				
Brâu / Listel	50 x 2,5 x 0,9	EN 14411:2012, Annex K, BIII GL	20	0,25				
Gresie porțelanată / Porcelain tile	45 x 45 x 0,9	EN 14411:2012, Annex G, Bla GL	7	1,42	52	73,84	26,3	1395





**2051-0198**  
ivoriu/ivory | mat/matt



50 x 25



V3



**2051-0199**  
ivoriu/ivory | mat/matt



**2651-0099**  
ivoriu/ivory | mat/matt



**2505-0124**  
ivoriu/ivory | mat/matt

50 x 2,5



**6046-0452**  
ivoriu/ivory | mat/matt PEI 5



45 x 45





V3



# Cromatic Gloss



produs / product	cm	EN		m <sup>2</sup>		m <sup>2</sup>	kg	brutto kg
Faianță / Wall tile	50 x 25 x 0,9	EN 14411:2012, Annex K, BIII GL	11	1,38	45	62,10	21,0	970
Decor / Insert	50 x 25 x 0,9	EN 14411:2012, Annex K, BIII GL	10	1,25				
Brâu / Listel	50 x 2,5 x 0,9	EN 14411:2012, Annex K, BIII GL	20	0,25				
Gresie porțelanată rectificată / Porcelain rectified tile	60 x 15 x 0,9	EN 14411:2012, Annex G, BIa GL	11	0,99	48	47,52	18,7	922



50 x 25



V1

**2051-0210**  
alb/white | lucios/glossy

SL

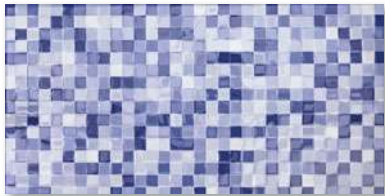

**2051-0212**  
albastru/blue | lucios/glossy

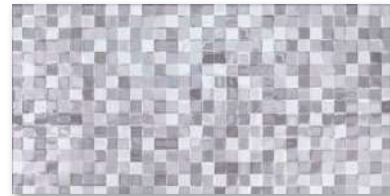

50 x 25



V2

**2051-0211**  
gri/gray | lucios/glossy



**2651-0108**  
alb/white | lucios/glossy



50 x 2,5



**2505-0121 Platină**  
platină/platinum | lucios/glossy



60 x 15



V3





**6463-0043 Rovere**  
gri/greige | mat/matt PEI 4



# Cromatic Gloss



produs / product	cm	EN		m <sup>2</sup>		m <sup>2</sup>	kg	brutto kg
Faianță / Wall tile	50 x 25 x 0,9	EN 14411:2012, Annex K, BIII GL	11	1,38	45	62,10	21,0	970
Decor / Insert	50 x 25 x 0,9	EN 14411:2012, Annex K, BIII GL	10 / 5 SET	1,25				
Gresie porțelanată rectificată / Rectified porcelain tile	60 x 30 x 0,9	EN 14411:2012, Annex G, BIIa GL	7	1,26	40	50,40	23,6	960
Gresie porțelanată rectificată / Porcelain rectified tile	60 x 15 x 0,9	EN 14411:2012, Annex G, BIIa GL	11	0,99	48	47,52	18,7	922



50 x 25

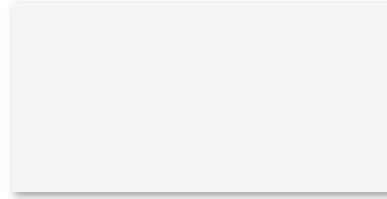

**2051-0152**  
alb/white | lucios/glossy

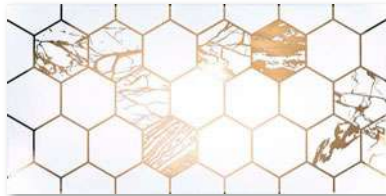

**2651-0101**  
alb/white | lucios/glossy



**2651-0102**  
alb/white | lucios/glossy



**2651-0103**  
alb/white | lucios/glossy

**SET**



**2651-0104**  
alb/white | lucios/glossy

**SET**



60 x 15



**6463-0031 Pavimento**  
bej/beige | mat/matt PEI 4



**6460-0270 Tanum**  
antracit/anthracite | mat/matt PEI 4

60 x 30



# Nalim







# Nalim



## RECOMANDARE / RECOMMENDATION

Înainte de a monta plăcile, vă sugerăm să selectați din mai multe cutii, să amestecați plăcile (inclusiv prin rotirea lor cu 180°) și să le aranjați așa cum este ilustrat în fotografia de inspirație sau să consultați site-ul [www.cesarom.ro](http://www.cesarom.ro).

Before laying the tiles, we suggest you select from several boxes and arrange them as illustrated in the inspiration photo above or consult the [www.cesarom.ro](http://www.cesarom.ro) website and mix the tiles to achieve the required result including turning them by 180°.

produs / product	cm	EN		m <sup>2</sup>		m <sup>2</sup>	kg	brutto kg
Faianță / Wall tile	50 x 25 x 0,9	EN 14411:2012, Annex K, BIII GL	11	1,38	45	62,10	21,0	970
Decor / Insert	50 x 25 x 0,9	EN 14411:2012, Annex K, BIII GL	10	1,25				
Brâu / Listel	50 x 2,5 x 0,9	EN 14411:2012, Annex K, BIII GL	20	0,25				
Gresie porțelanată / Porcelain tile	45 x 45 x 0,9	EN 14411:2012, Annex G, BIa GL	7	1,42	52	73,84	26,3	1395
Gresie porțelanată rectificată / Rectified porcelain tile	60 x 30 x 0,9	EN 14411:2012, Annex G, BIa GL	7	1,26	40	50,40	23,6	960





**2051-0176**  
gri deschis/light gray | mat/matt



SL



**2051-0175**  
gri deschis/light gray | mat/matt

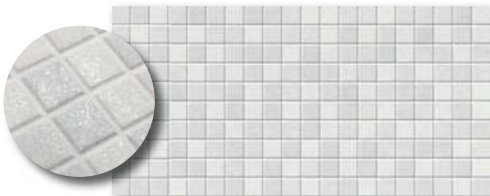

**2051-0178**  
gri deschis/light gray | mat/matt



**2051-0177**  
gri deschis/light gray | mat/matt



**2651-0091**  
multicolor/multicolour | mat/matt



**2505-0121 Platină**  
platină/platinum | lucios/glossy

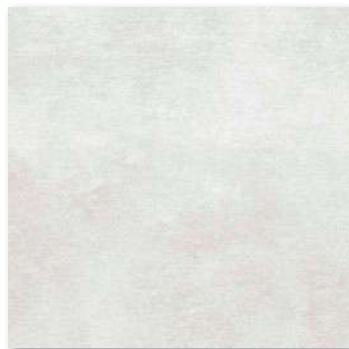

**6046-0437**  
gri deschis/light gray | mat/matt PEI 4

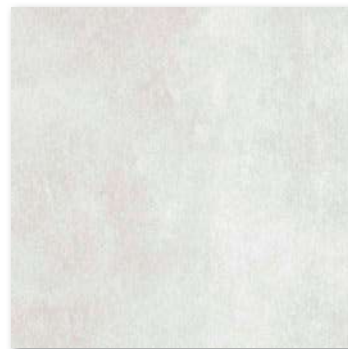

**6460-0281 Wright**  
gri/gray | mat/matt PEI 4



**6460-0284 Rovere**  
maro/brown | mat/matt PEI 4

50 x 25



V2

50 x 2,5



45 x 45



V2



V2

60 x 30



V3



# Stripes



## RECOMANDARE / RECOMMENDATION

Înainte de a monta plăcile, vă sugerăm să selectați din mai multe cutii, să amestecați plăcile (inclusiv prin rotirea lor cu 180°) și să le aranjați așa cum este ilustrat în fotografia de inspirație sau să consultați site-ul [www.cesarom.ro](http://www.cesarom.ro).

Before laying the tiles, we suggest you select from several boxes and arrange them as illustrated in the inspiration photo above or consult the [www.cesarom.ro](http://www.cesarom.ro) website and mix the tiles to achieve the required result including turning them by 180°.

Produs / Product	 cm	 EN		 m <sup>2</sup>		 m <sup>2</sup>	 kg	 brutto kg
Faianță / Wall tile	50 x 25 x 0,9	EN 14411:2012, Annex K, BIII GL	11	1,38	45	62,10	21,0	970
Decor / Insert	50 x 25 x 0,9	EN 14411:2012, Annex K, BIII GL	5 SET	1,25				
Brău / Listel	50 x 2,5 x 0,9	EN 14411:2012, Annex K, BIII GL	20	0,25				
Gresie / Floor tile	33 x 33 x 0,8	EN 14411:2012, Annex K, BIII GL	15	1,63	42	68,46	24,0	1035



50 x 25



V2

**2051-0108**  
gri deschis/light gray | lucios/glossy



**2051-0109**  
gri/gray | lucios/glossy

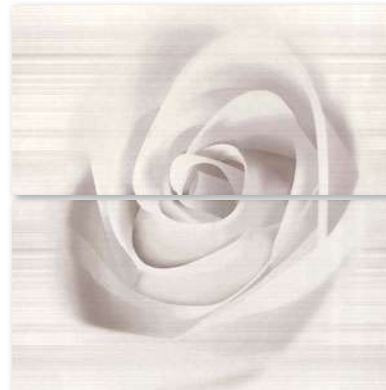

**2651-0069** SET  
gri/gray | lucios/glossy



**2505-0121 Platină**  
platină/platinum | lucios/glossy

50 x 2,5



**4035-0227**  
gri/gray | mat/matt PEI 3

33 x 33



V2



# Calacatta Oro



## RECOMANDARE / RECOMMENDATION

Înainte de a monta plăcile, vă sugerăm să selectați din mai multe cutii, să amestecați plăcile (inclusiv prin rotirea lor cu 180°) și să le aranjați așa cum este ilustrat în fotografia de inspirație sau să consultați site-ul [www.cesarom.ro](http://www.cesarom.ro).

Before laying the tiles, we suggest you select from several boxes and arrange them as illustrated in the inspiration photo above or consult the [www.cesarom.ro](http://www.cesarom.ro) website and mix the tiles to achieve the required result including turning them by 180°.

Produs / Product	cm	EN		m <sup>2</sup>		m <sup>2</sup>	kg	brutto kg
Faiantă / Wall tile	40,2 x 25,2 x 0,8	EN 14411:2012, Annex K, BIII GL	15	1,52	54	82,08	21,0	1160
Decor / Insert	40,2 x 25,2 x 0,8	EN 14411:2012, Annex K, BIII GL	10	1,01				
Brâu / Listel	40,2 x 3 x 0,75	EN 14411:2012, Annex K, BIII GL	48	0,46				
Gresie / Floor tile	45 x 45 x 0,9	EN 14411:2012, Annex K, BIII GL	7	1,42	52	73,84	23,7	1257



40.2 x 25.2



**2042-0571**  
alb/white | lucios/glossy



**2042-0572**  
alb/white | lucios/glossy



**2642-0490**  
alb-auriu/white-gold | lucios/glossy



**2504-0215**  
auriu/gold | lucios/glossy

40.2 x 3



**4046-0133**  
alb/white | lucios/glossy PEI 3



**4046-0132**  
alb/white | lucios/glossy PEI 3

45 x 45



# Carving



## RECOMANDARE / RECOMMENDATION

Înainte de a monta plăcile, vă sugerăm să selectați din mai multe cutii, să amestecați plăcile (inclusiv prin rotirea lor cu 180°) și să le aranjați așa cum este ilustrat în fotografia de inspirație sau să consultați site-ul [www.cesarom.ro](http://www.cesarom.ro).

Before laying the tiles, we suggest you select from several boxes and arrange them as illustrated in the inspiration photo above or consult the [www.cesarom.ro](http://www.cesarom.ro) website and mix the tiles to achieve the required result including turning them by 180°.

Produs / Product	cm	EN		m <sup>2</sup>		m <sup>2</sup>	kg	brutto kg
Faianță / Wall tile	40,2 x 25,2 x 0,8	EN 14411:2012, Annex K, BIII GL	15	1,52	54	82,08	21,0	1160
Gresie porțelanată / Porcelain tile	45 x 45 x 0,9	EN 14411:2012, Annex G, BIIa GL	7	1,42	52	73,84	26,3	1395



40.2 x 25.2



V4



**2042-0521**  
maro/brown | mat/matt



**6046-0451 Natura**  
grej/greige | mat/matt PEI 5



**6046-0450 Natura**  
bej/beige | mat/matt PEI 4

45 x 45



V2

# Cromatic 3D



Produs / Product



EN



Faianță / Wall tile

40,2 x 25,2 x 0,8

EN 14411:2012, Annex K, BIII GL

15

1,52

54

82,08

21,0

1160

Decor / Insert

40,2 x 25,2 x 0,8

EN 14411:2012, Annex K, BIII GL

10

1,01

Brâu / Listel

40,2 x 3 x 0,75

EN 14411:2012, Annex K, BIII GL

48

0,46

Gresie porțelanată / Porcelain tile

33 x 33 x 0,75

EN 14411:2012, Annex G, BIa GL

15

1,63

42

68,46

26

1120





SL



40.2 x 25.2



V1

**2042-0568**  
alb/white | lucios/glossy

SL

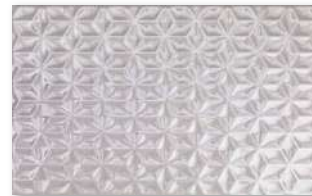

**2042-0570**  
gri/gray | lucios/glossy

SL



**2042-0569**  
roșu/red | lucios/glossy

SL



**2642-0489**  
alb/white | lucios/glossy



40.2 x 3



**2504-0215**  
auriu/gold | lucios/glossy



V2

**6035-0181 Tanum**  
gri deschis/light gray | mat/matt PEI 5



33 x 33



V1

**6035-0222 Romantica**  
roșu/red | lucios/glossy PEI 3

# Flavours



Produs / Product	cm	EN		m <sup>2</sup>		m <sup>2</sup>	kg	brutto kg
Faianță / Wall tile	40,2 x 25,2 x 0,8	EN 14411:2012, Annex K, BIII GL	15	1,52	54	82,08	21,0	1160
Decor / Insert	40,2 x 25,2 x 0,8	EN 14411:2012, Annex K, BIII GL	10	1,01				
Brâu / Listel	25,2 x 6,5 x 0,8	EN 14411:2012, Annex K, BIII GL	34	0,56				



SL



40.2 x 25.2



V2

**2042-0200**  
bej/beige | mat/matt

SL



**2642-0281**  
bej/beige | mat/matt

SL



25.2 x 6.5



**2502-0761**  
bej/beige | mat/matt

# Fresh



Produs / Product	cm	EN		m <sup>2</sup>		m <sup>2</sup>	kg	brutto kg
Faianță / Wall tile	40,2 x 25,2 x 0,8	EN 14411:2012, Annex K, BIII GL	15	1,52	54	82,08	21,0	1160
Decor / Insert	40,2 x 25,2 x 0,8	EN 14411:2012, Annex K, BIII GL	5 SET	1,01				
Brâu / Listel	40,2 x 5,0 x 0,8	EN 14411:2012, Annex K, BIII GL	22	0,44				
Gresie porțelanată / Porcelain tile	33 x 33 x 0,75	EN 14411:2012, Annex G, BIIa GL	15	1,63	42	68,46	26	1120



SL

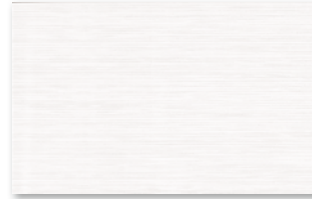

40.2 x 25.2



V2

**2042-0422**  
alb/white | lucios/glossy

SL



**2042-0425**  
roșu/red | lucios/glossy

SL



**2642-0441** (SET)  
roșu/red | lucios/glossy

SL



40.2 x 5



**2504-0180**  
roșu/red | lucios/glossy



33 x 33



V1

**6035-0222 Romantica**  
roșu/red | lucios/glossy PEI 3

# Marina



## RECOMANDARE / RECOMMENDATION

Înainte de a monta plăcile, vă sugerăm să selectați din mai multe cutii, să amestecați plăcile (inclusiv prin rotirea lor cu 180°) și să le aranjați așa cum este ilustrat în fotografia de inspirație sau să consultați site-ul [www.cesarom.ro](http://www.cesarom.ro).

Before laying the tiles, we suggest you select from several boxes and arrange them as illustrated in the inspiration photo above or consult the [www.cesarom.ro](http://www.cesarom.ro) website and mix the tiles to achieve the required result including turning them by 180°.

Produs / Product	cm	EN		m <sup>2</sup>		m <sup>2</sup>	kg	brutto kg
Faianță / Wall tile	40,2 x 25,2 x 0,8	EN 14411:2012, Annex K, BIII GL	15	1,52	54	82,08	21,0	1160
Brâu / Listel	40,2 x 6,0 x 0,8	EN 14411:2012, Annex K, BIII GL	24	0,60				
Gresie porțelanată / Porcelain tile	45 x 45 x 0,9	EN 14411:2012, Annex G, BIIa GL	7	1,42	52	73,84	26,3	1395



**2042-0517**  
alb/white | mat/matt



**2042-0518**  
maro/brown | mat/matt



**2042-0519**  
multicolor/multicolor | mat/matt



40.2 x 25.2



V2

V3

SL



**2042-0520**  
multicolor/multicolor | mat/matt



SL



**2504-0210**  
multicolor/multicolor | mat/matt

40.2 x 6



**6046-0451 Natura**  
grej/greige | mat/matt PEI 5



**6046-0450 Natura**  
bej/beige | mat/matt PEI 4

45 x 45



V2

# Nordic Wood



Produs / Product	cm	EN		m <sup>2</sup>		m <sup>2</sup>	kg	brutto kg
Faianță / Wall tile	40,2 x 25,2 x 0,8	EN 14411:2012, Annex K, BIII GL	15	1,52	54	82,08	21,0	1160
Decor / Insert	40,2 x 25,2 x 0,8	EN 14411:2012, Annex K, BIII GL	10	1,01				
Gresie porțelanată / Porcelain tile	45 x 45 x 0,9	EN 14411:2012, Annex G, BIIa GL	7	1,42	52	73,84	26,3	1395





**2042-0523**  
lucios/glossy

40.2 x 25.2



V3



**2042-0524**  
bej/beige | lucios/glossy



**2642-0481**  
bej/beige | lucios/glossy



**6046-0406**  
bej/beige | mat/matt PEI 4



45 x 45



V3



**6046-0513**  
maro/brown | mat/matt PEI 4











# Travertine



## RECOMANDARE / RECOMMENDATION

Înainte de a monta plăcile, vă sugerăm să selectați din mai multe cutii, să amestecați plăcile (inclusiv prin rotirea lor cu 180°) și să le aranjați așa cum este ilustrat în fotografia de inspirație sau să consultați site-ul [www.cesarom.ro](http://www.cesarom.ro).

Before laying the tiles, we suggest you select from several boxes and arrange them as illustrated in the inspiration photo above or consult the [www.cesarom.ro](http://www.cesarom.ro) website and mix the tiles to achieve the required result including turning them by 180°.

Produs / Product	 cm	 EN		 m <sup>2</sup>		 m <sup>2</sup>	 kg	 brutto kg
Faianță / Wall tile	40,2 x 25,2 x 0,8	EN 14411:2012, Annex K, BIII GL	15	1,52	54	82,08	21,0	1160
Decor / Insert	40,2 x 25,2 x 0,8	EN 14411:2012, Annex K, BIII GL	10	1,01				
Brâu / Listel	25,2 x 6,0 x 0,8	EN 14411:2012, Annex K, BIII GL	34	0,51				
Gresie porțelanată / Porcelain tile	45 x 45 x 0,9	EN 14411:2012, Annex G, BIa GL	7	1,42	52	73,84	26,3	1395
Decor gresie porțelanată / Insert porcelain tile	45 x 45 x 0,9	EN 14411:2012, Annex G, BIa GL	2 SET	0,81			15,5	



**2042-0365**  
bej/beige | mat/matt



40.2 x 25.2



V2



**2642-0449**  
bej/beige | mat/matt



**2642-0480**  
bej/beige | mat/matt

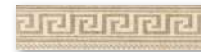

**2502-0899**  
bej/beige | mat/matt

25.2 x 6



**6046-0131**  
bej/beige | mat/matt PEI 5



45 x 45



V2



**6646-0009**  
bej/beige | mat/matt PEI 5

SET = 2 buc

# E-Project / Ivory



Produs / Product	cm	EN	cm	m <sup>2</sup>	cm	m <sup>2</sup>	kg	brutto kg
Faianță / Wall tile	40,2 x 20,2 x 0,75	EN 14411-2012, Annex K, BIII GL	16	1,30	54	70,20	15,5	865
Decor / Insert	40,2 x 20,2 x 0,75	EN 14411-2012, Annex K, BIII GL	10	0,81				
Gresie porțelanată / Porcelain tile	45 x 45 x 0,9	EN 14411-2012, Annex G, BIIa GL	7	1,42	52	73,84	26,3	1395



SL

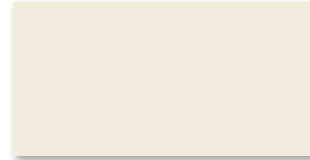
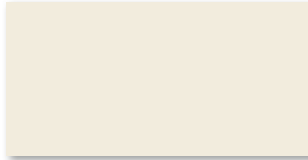

40.2 x 20.2



V1

**2041-0114**  
ivoriu/ivory | lucios/glossy

SL



**2041-0139**  
ivoriu/ivory | lucios/glossy



SL



**2041-0150**  
ivoriu/ivory | lucios/glossy

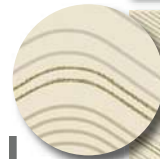

**2641-0127**  
ivoriu/ivory | lucios/glossy



SL



**2041-0151**  
ivoriu/ivory | lucios/glossy

45 x 45





V2



**6046-0450 Natura**  
bej/beige | mat/matt PEI 4

# Fabric



Produs / Product	cm	EN		m <sup>2</sup>		m <sup>2</sup>	kg	brutto kg
Faianță / Wall tile	40,2 x 20,2 x 0,75	EN 14411:2012, Annex K, BIII GL	16	1,30	54	70,20	15,5	865
Decor / Insert	40,2 x 20,2 x 0,75	EN 14411:2012, Annex K, BIII GL	10	0,81				
Brâu / Listel	40,2 x 3 x 0,75	EN 14411:2012, Annex K, BIII GL	46	0,55				
Gresie / Floor tile	33 x 33 x 0,8	EN 14411:2012, Annex K, BIII GL	15	1,63	42	68,46	24,0	1035
Gresie portelanată / Porcelain tile	45 x 45 x 0,9	EN 14411:2012, Annex G, BIa GL	7	1,42	52	73,84	26,3	1395



SL



**2041-0128**  
bej/beige | lucios/glossy

SL



**2041-0148**  
caramel/caramel | lucios/glossy

40.2 x 20.2



V2

SL

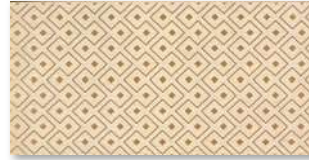

**2641-0121**  
bej/beige | lucios/glossy

SL



**2041-0147**  
bej/beige | lucios/glossy



SL



**2504-0206**  
cromato/cromato | mat/matt

40.2 x 3



SL



**4035-0231**  
caramel/caramel | mat/matt PEI 3

33 x 33



V2



**6046-0137 Norway**  
maro/brown | mat/matt PEI 4

45 x 45



V3

# Maiolica



Produs / Product



brutto kg

Faianță / Wall tile

40,2 x 20,2 x 0,75

EN 14411:2012, Annex K, BIII GL

16

1,30

54

70,20

15,5

865

222

Gresie porțelanată / Porcelain tile

45 x 45 x 0,9

EN 14411:2012, Annex G, BIIa GL

7

1,42

52

73,84

26,3

1395





SL

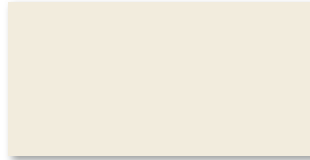

**2041-0114**  
ivoriu/ivory | lucios/glossy

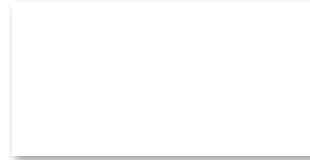

**2041-0086**  
alb/white | lucios/glossy

40.2 x 20.2



V1

SL



**2041-0139**  
ivoriu/ivory | lucios/glossy

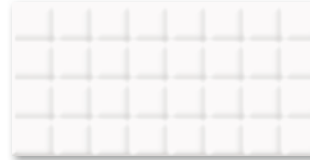

**2041-0138**  
alb/white | lucios/glossy

SL



**2041-0146**  
ivoriu/ivory | lucios/glossy

SL



**2041-0145**  
alb/white | lucios/glossy

45 x 45



V2



**6046-0366 Crust**  
gri/gray | mat/matt PEI 5



**6046-0450 Natura**  
bej/beige | mat/matt PEI 4



**6046-0451 Natura**  
grij/greige | mat/matt PEI 5

# Argila



Produs / Product





33 x 33



**6035-0358**  
maro/brown | mat/matt PEI 4

**RECOMANDARE / RECOMMENDATION**

Înainte de a monta plăcile, vă sugerăm să selectați din mai multe cutii, să amestecați plăcile (inclusiv prin rotirea lor cu 180°) și să le aranjați așa cum este ilustrat în fotografia de inspirație sau să consultați site-ul [www.cesarom.ro](http://www.cesarom.ro).

Before laying the tiles, we suggest you select from several boxes and arrange them as illustrated in the inspiration photo above or consult the [www.cesarom.ro](http://www.cesarom.ro) website and mix the tiles to achieve the required result including turning them by 180°.



## Garden



## Grecia

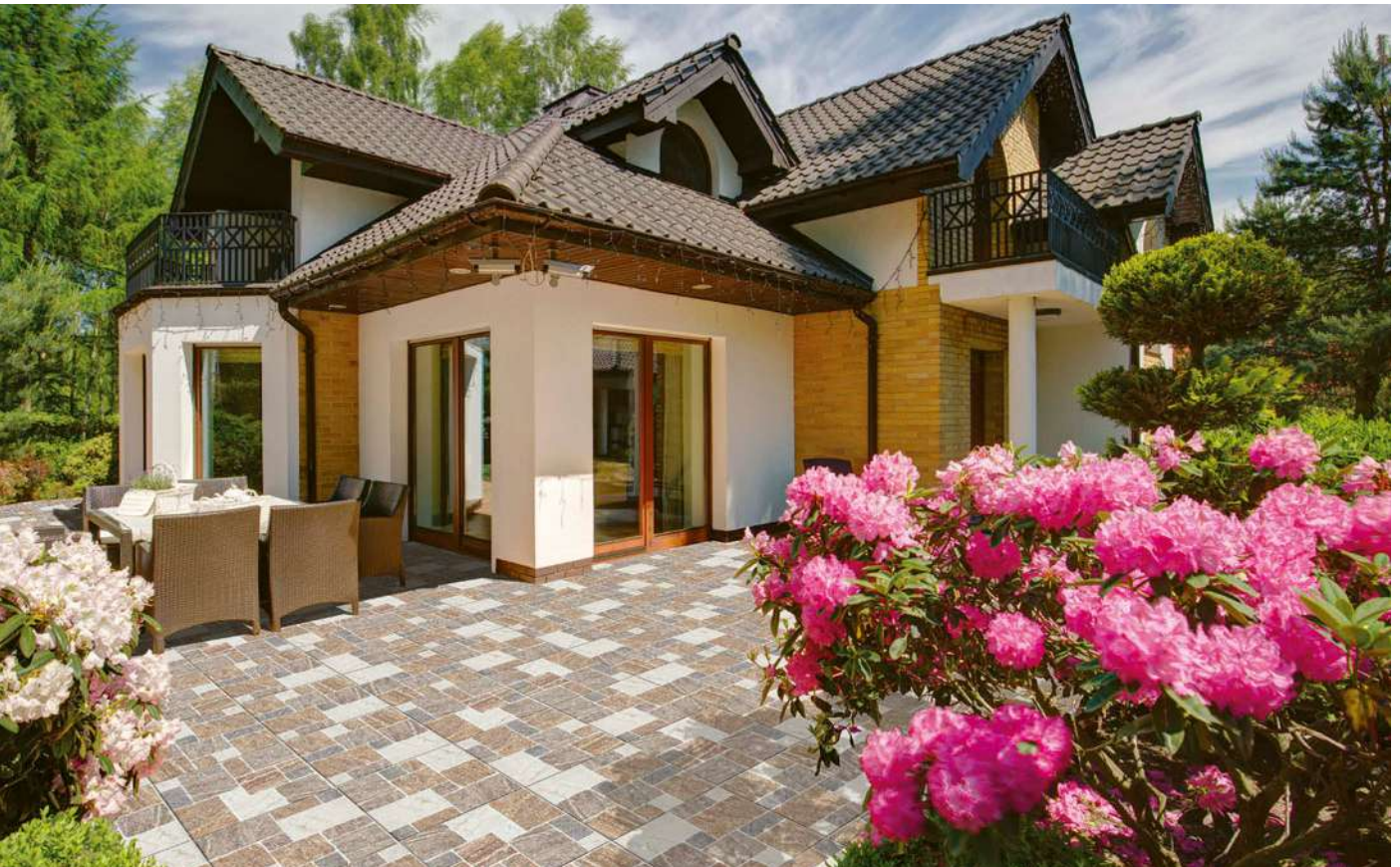

Produs / Product



Gresie porțelanată / Porcelain tile

33 x 33 x 0,75

EN 14411:2012, Annex G, Bla GL

15

1,63

42

68,46

26

1120



**6035-0328**  
multicolor/multicolor | mat/matt PEI 4

33 x 33



**6035-0241**  
multicolor/multicolor | mat/matt PEI 4

33 x 33



#### RECOMANDARE / RECOMMENDATION

Înainte de a monta plăcile, vă sugerăm să selectați din mai multe cutii, să amestecați plăcile (inclusiv prin rotirea lor cu 180°) și să le aranjați așa cum este ilustrat în fotografia de inspirație sau să consultați site-ul [www.cesarom.ro](http://www.cesarom.ro).

Before laying the tiles, we suggest you select from several boxes and arrange them as illustrated in the inspiration photo above or consult the [www.cesarom.ro](http://www.cesarom.ro) website and mix the tiles to achieve the required result including turning them by 180°.



# Quartzite



## RECOMANDARE / RECOMMENDATION

Înainte de a monta plăcile, vă sugerăm să selectați din mai multe cutii, să amestecați plăcile (inclusiv prin rotirea lor cu 180°) și să le aranjați așa cum este ilustrat în fotografia de inspirație sau să consultați site-ul [www.cesarom.ro](http://www.cesarom.ro).

Before laying the tiles, we suggest you select from several boxes and arrange them as illustrated in the inspiration photo above or consult the [www.cesarom.ro](http://www.cesarom.ro) website and mix the tiles to achieve the required result including turning them by 180°.

Produs / Product



EN



Gresie porțelanată / Porcelain tile

33 x 33 x 0,75

EN 14411:2012, Annex G, Bla GL

15

1,63

42

68,46

26

1120



**CESAROM®**



33 x 33



**6035-0197**  
maro/brown | mat/matt PEI 4







**RAKO**

Brand of lasselsbergergroup

**Home**

2024

# castone



produs / product



80×80



798×798×10

EN

EN 14411 - G Bla



2



1,6



1,28



42



53,76



28,0



21,9



1 202

gresie portelanată / porcelain tile



80x80

R10

B

V3



6485-0034 / DAK81858  
 PEI 5  83 l m<sup>2</sup>  
 mat | matt  
 color **dune**  
 bej / beige



6485-0032 / DAK81856  
 PEI 5  83 l m<sup>2</sup>  
 mat | matt  
 color **cement**  
 gri / grey



6485-0031 / DAK81855  
 PEI 5  83 l m<sup>2</sup>  
 mat | matt  
 color **paper**  
 alb-gri / white-grey

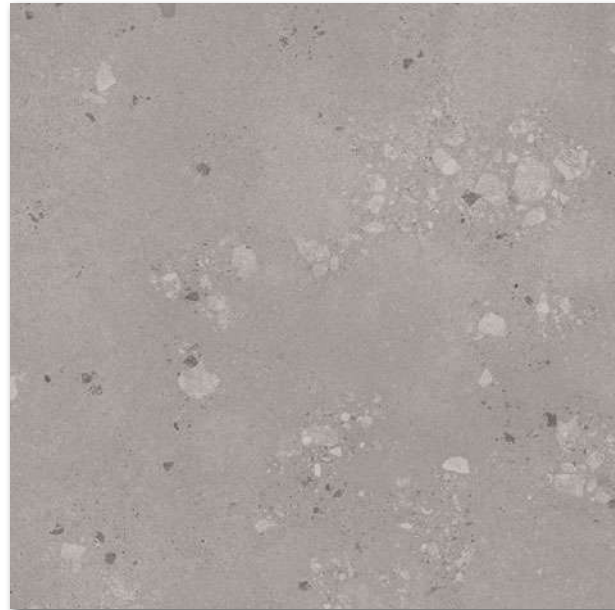

6485-0033 / DAK81857  
 PEI 4  83 l m<sup>2</sup>  
 mat | matt  
 color **ash**  
 gri închis / dark grey

Înainte de a monta plăcile, vă sugerăm să selectați din mai multe cutii, să amestecați plăcile (inclusiv prin rotirea lor cu 180°) și să le aranjați așa cum este ilustrat în fotografia de inspirație sau să consultați site-ul [www.cesarom.ro](http://www.cesarom.ro).

Before laying the tiles, we suggest you select from several cartons and arrange them as illustrated in the inspiration photo documentation in RAKO catalogues or website [www.cesarom.ro](http://www.cesarom.ro). There are two recommended laying patterns to choose from: one is a strictly one-way oriented design, and the other resembles a chessboard look achieved through a regular 90° turn tiling pattern

# castone



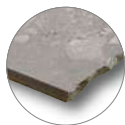

6461-0305 / DAK62858  
 PEI 5 ○ 82 l m<sup>2</sup>  
 mat | matt  
 color **dune**  
 bej / beige



6461-0303 / DAK62856  
 PEI 5 ○ 82 l m<sup>2</sup>  
 mat | matt  
 color **cement**  
 gri / grey



6461-0302 / DAK62855  
 PEI 5 ○ 82 l m<sup>2</sup>  
 mat | matt  
 color **paper**  
 alb-gri / white-grey

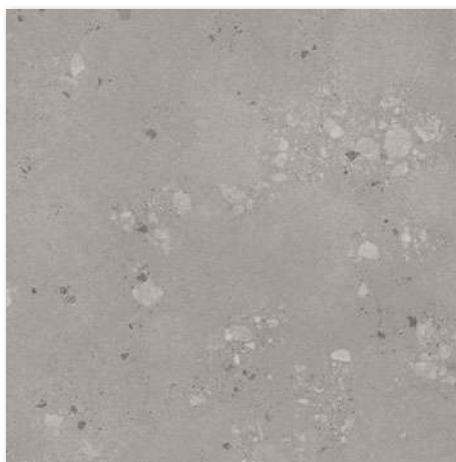

6461-0304 / DAK62857  
 PEI 4 ○ 82 l m<sup>2</sup>  
 mat | matt  
 color **ash**  
 gri închis / dark grey

product / product



60x60



598x598+9



EN 14411 - G B1a



4



2,8



1,44



32



46,08



27,6



19,2



908



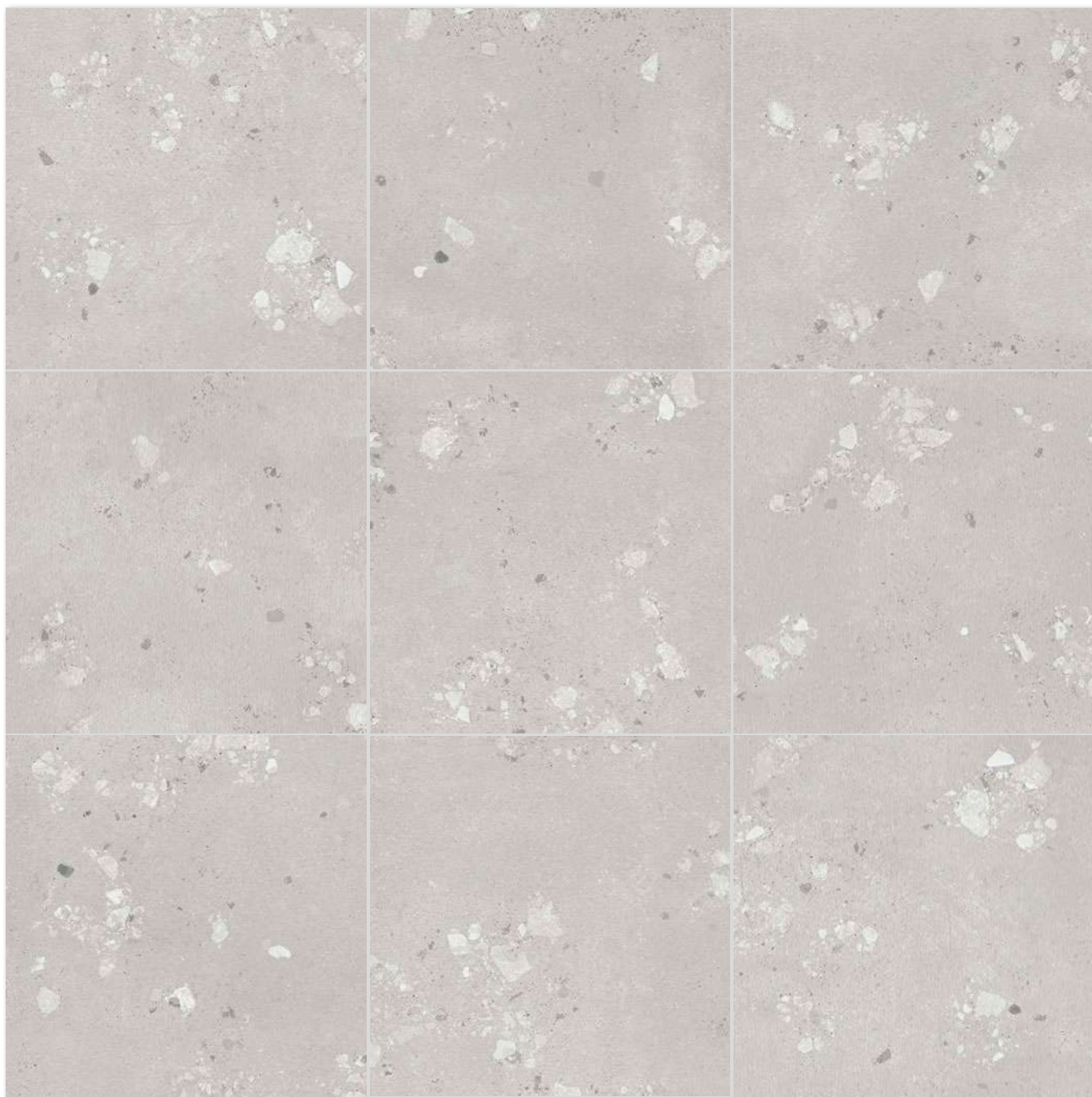







gresie porțelanată / porcelain tile



Înainte de a monta plăcile, vă sugerăm să selectați din mai multe cutii, să amestecați plăcile (inclusiv prin rotirea lor cu 180°) și să le aranjați așa cum este ilustrat în fotografia de inspirație sau să consultați site-ul [www.cesarom.ro](http://www.cesarom.ro).

Before laying the tiles, we suggest you select from several cartons and arrange them as illustrated in the inspiration photo documentation in RAKO catalogues or website [www.cesarom.ro](http://www.cesarom.ro).

There are two recommended laying patterns to choose from: one is a strictly one-way oriented design, and the other resembles a chessboard look achieved through a regular 90° turn tiling pattern.

produs / product											
gresie porțelanată / porcelain tile	10×10	98×98×9	EN 14411 - G B Ia	11	11	1,00	56	56,00	19,2	19,2	1 125
mozaic set 30×30 cm / mosaic sheet 30×30 cm	5×5	48×48×8	STO Ę. 030 - 059826	4	11	0,36	-	-	5,2	14,8	-
treaptă / step tile	60×60	598×597×9	STO Ę. 030 - 059824	3	2,8	1,08	-	-	20,7	19,2	-
treaptă / step tile	40×80	398×798×10	STO Ę. 030 - 059824	2	3,1	0,64	-	-	14,1	21,9	-
plintă / skirting plinth	80×9,5	798×95×10	STO Ę. 030 - 059824	10	13,2	0,76	-	-	16,7	21,9	-
plintă / skirting plinth	60×7,2	598×72×9	STO Ę. 030 - 059824	14	23,1	0,60	-	-	11,5	19,2	-
treaptă specială / special step tile	40×80	398×798×10	STO Ę. 030 - 059824	2	-	-	-	-	-	-	-



10x10 | 30x30



DAK11858 (SET)  
PEI 5 ○ 94 | m<sup>2</sup>  
mat | matt  
color **dune**  
bej / beige



DAK11855 (SET)  
PEI 5 ○ 94 | m<sup>2</sup>  
mat | matt  
color **paper**  
gri deschis / light grey

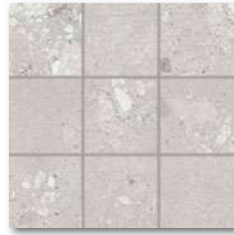

DAK11856 (SET)  
PEI 5 ○ 94 | m<sup>2</sup>  
mat | matt  
color **cement**  
gri / grey

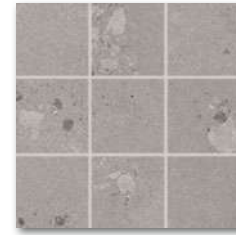

DAK11857 (SET)  
PEI 4 ○ 94 | m<sup>2</sup>  
mat | matt  
color **ash**  
gri închis / dark grey

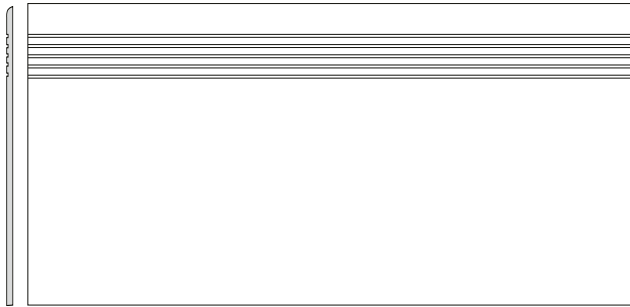

DCP84855 color **paper** | gri deschis / light grey  
DCP84856 color **cement** | gri / grey  
DCP84857 color **ash** | gri închis / dark grey  
DCP84858 color **dune** | bej / beige  
PEI 4-5 ○ 78 | ks  
mat | matt

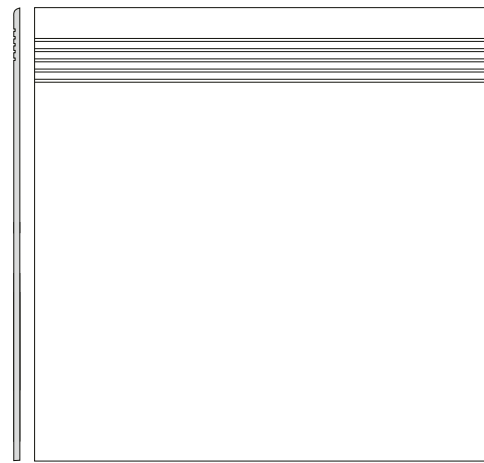

DCP62855 color **paper** | gri deschis / light grey  
DCP62856 color **cement** | gri / grey  
DCP62857 color **ash** | gri închis / dark grey  
DCP62858 color **dune** | bej / beige  
PEI 4-5 ○ 76 | ks  
mat | matt



DSA89855 color **paper** | gri deschis / light grey  
DSA89856 color **cement** | gri / grey  
DSA89857 color **ash** | gri închis / dark grey  
DSA89858 color **dune** | bej / beige  
○ 72 | ks  
mat | matt

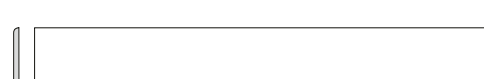

DSAS3855 color **paper** | gri deschis / light grey  
DSAS3856 color **cement** | gri / grey  
DSAS3857 color **ash** | gri închis / dark grey  
DSAS3858 color **dune** | bej / beige  
○ 56 | ks  
mat | matt

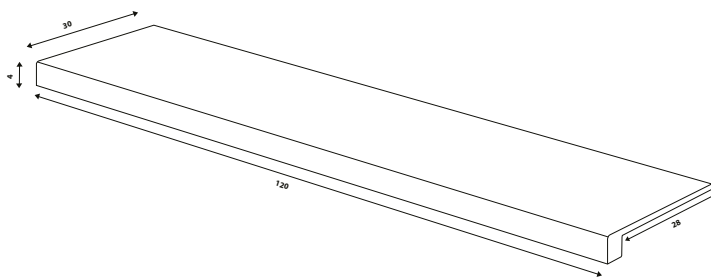

DCF84855 color **paper** | gri deschis / light grey  
DCF84856 color **cement** | gri / grey  
DCF84857 color **ash** | gri închis / dark grey  
DCF84858 color **dune** | bej / beige  
PEI 4-5 ○ 108 | ks  
mat | matt

40x80  
60x60



News

Home

**RAKO**

80x9,5  
60x7,2



40x80



**castone** outdoor

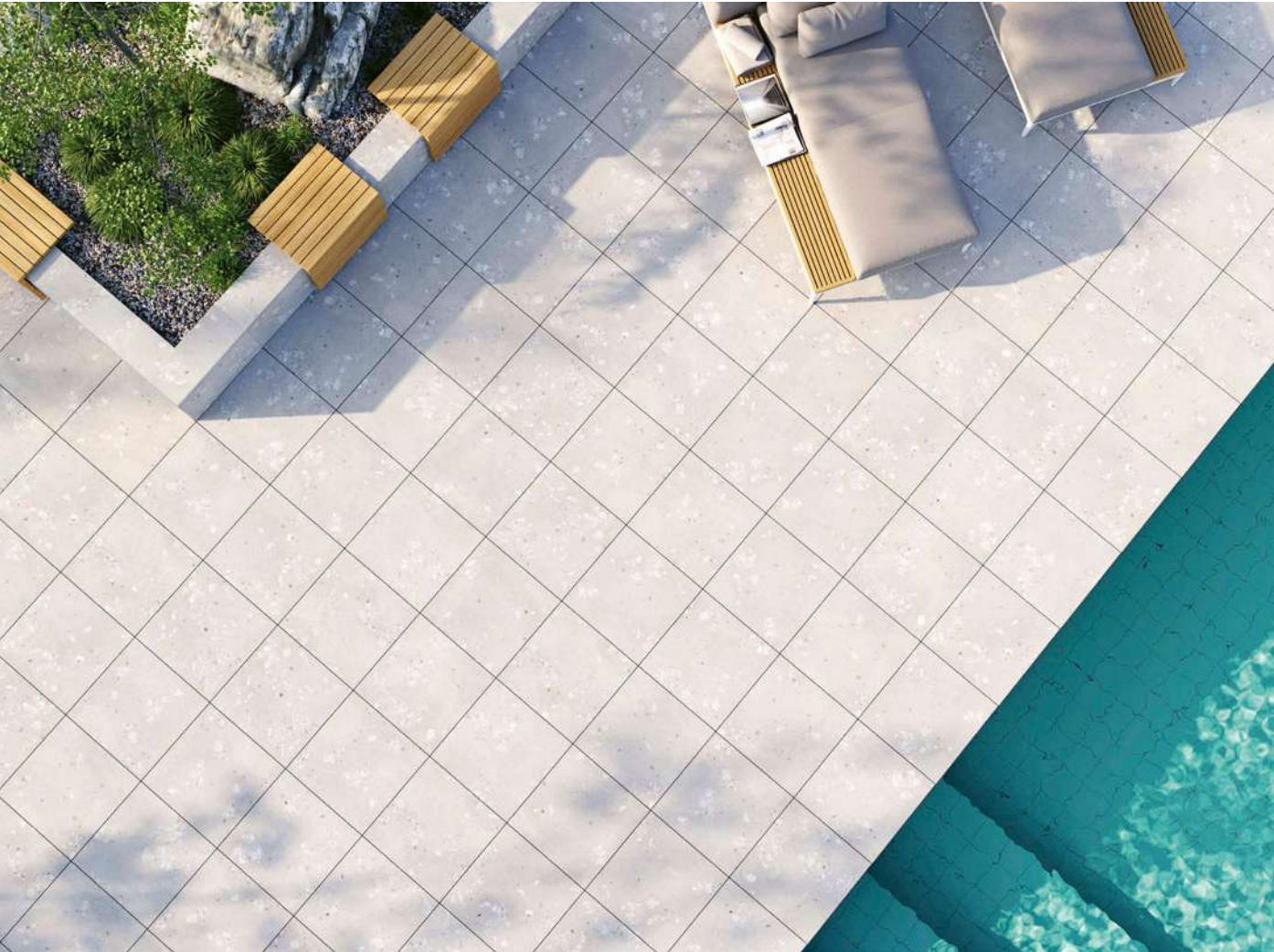



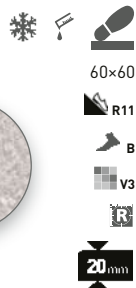
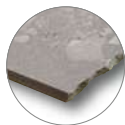

6461-0315 / DAR66858  
 PEI 5 ○ 89 | m<sup>2</sup>  
 mat | matt  
 color **dune**  
 bej / beige

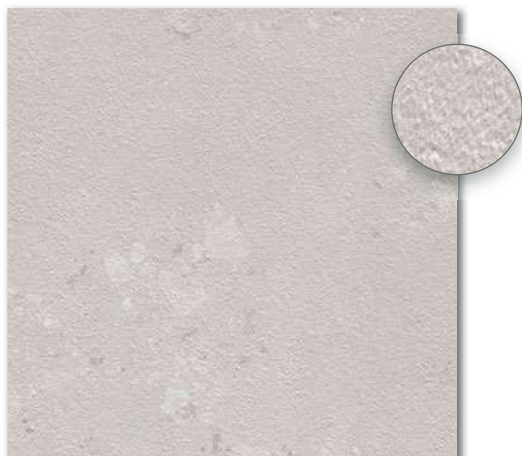

6461-0313 / DAR66856  
 PEI 5 ○ 89 | m<sup>2</sup>  
 mat | matt  
 color **cement**  
 gri / grey

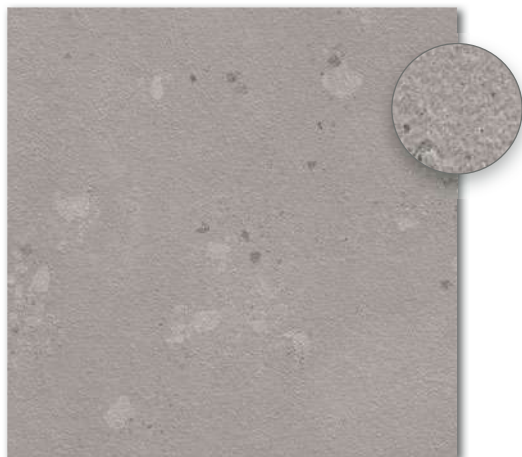

6461-0314 / DAR66857  
 PEI 4 ○ 89 | m<sup>2</sup>  
 mat | matt  
 color **ash**  
 gri închis / dark grey

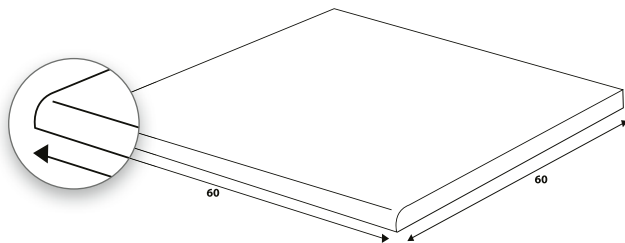

DCH66856 color **cement** | gri / grey  
 DCH66857 color **ash** | bej închis / dark grey  
 DCH66858 color **dune** | bej / beige  
 PEI 4-5 ○ 92 | ks  
 mat | matt

produs / product



gresie porțelanată / porcelain tile  
 treaptă / step tile

60×60 598-598×20  
 60×60 598-598×20

EN EN 14411 - G B1a  
 ST0 c. 030 - 059824

2  
 2

2,8  
 -

0,72  
 -

30  
 -

21,60  
 -

32,0  
 32,0

44,4  
 -

985  
 -

vals

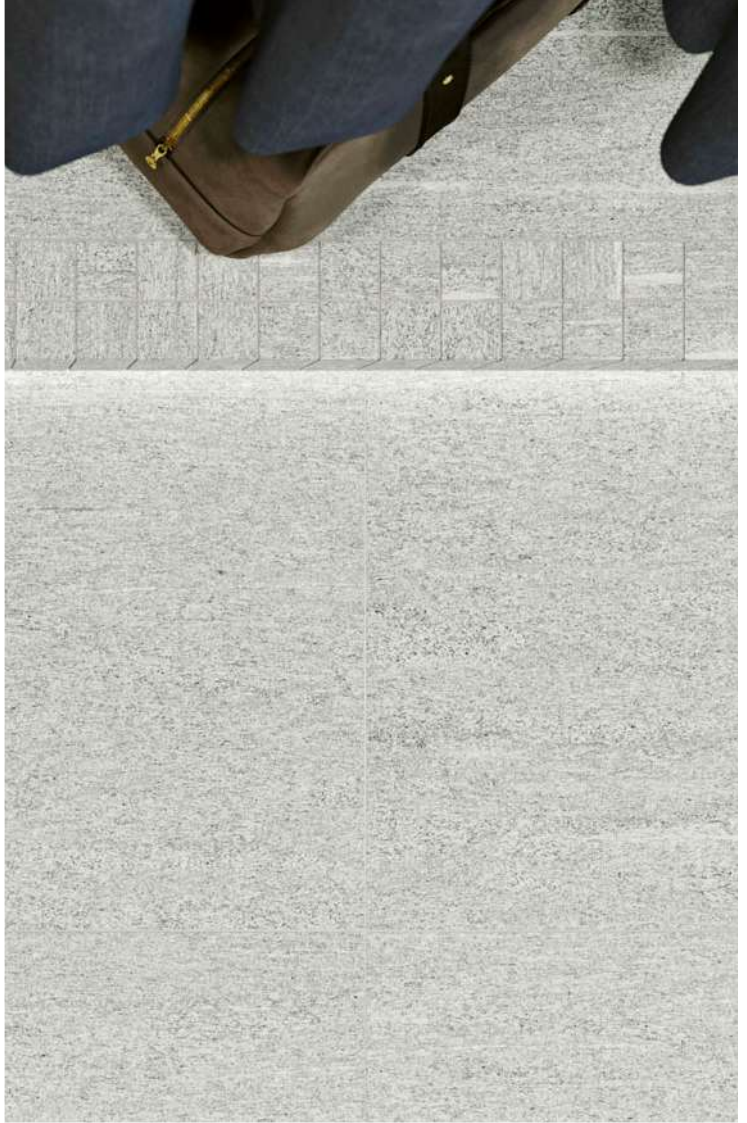



News

Home

**RAKO**



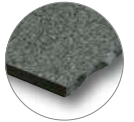

60x120

R10

B

V3

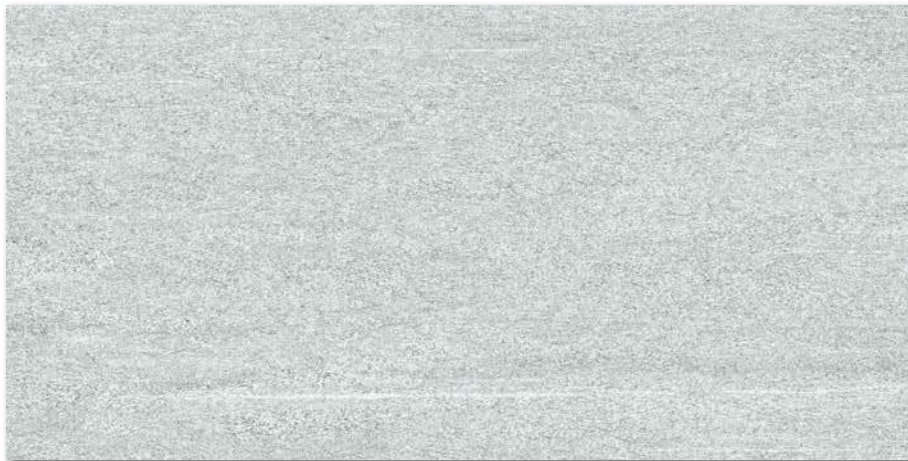

6493-0063 / DAKV1846

PEI 5 ○ 87 l m<sup>2</sup>

mat | matt

color **fog**

gri deschis / light grey

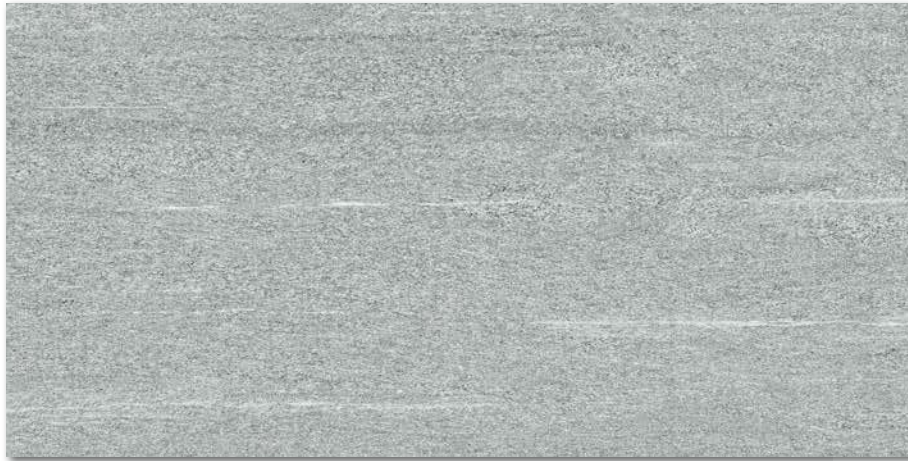

6493-0064 / DAKV1847

PEI 4 ○ 87 l m<sup>2</sup>

mat | matt

color **natural**

gri / grey



6493-0065 / DAKV1848

PEI 4 ○ 87 l m<sup>2</sup>

mat | matt

color **pepper**

gri închis / dark grey

produs / product



produs / product	60x120	60x60	60x15/10/5	598x1198x10	598x598x9	598x148/98/48x9	EN	2	1,4	1,44	27	38,88	32,7	22,7	908
gresie porțelanată / porcelain tile				EN 14411 - G Bla	EN 14411 - G Bla	EN 14411 - G Bla		4	2,8	1,44	32	46,08	27,6	19,2	908
gresie porțelanată / porcelain tile				EN 14411 - G Bla	EN 14411 - G Bla	EN 14411 - G Bla		15	16,7	0,90	36	32,40	17,5	19,2	655

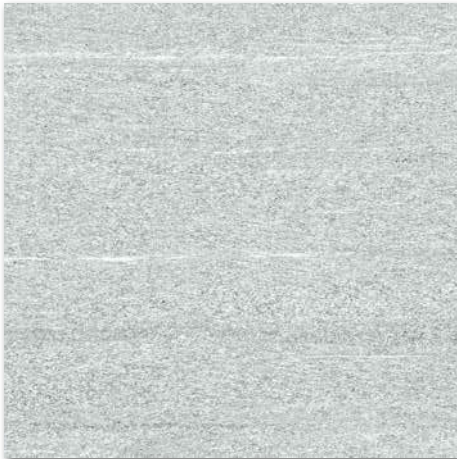
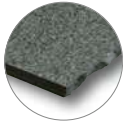

6461-0299 / DAK62846  
 PEI 5 ○ 80 l m<sup>2</sup>  
 mat | matt  
 color **fog**  
 gri deschis / light grey



DAKSV846  
 PEI 5 ○ 94 l m<sup>2</sup>  
 mat | matt

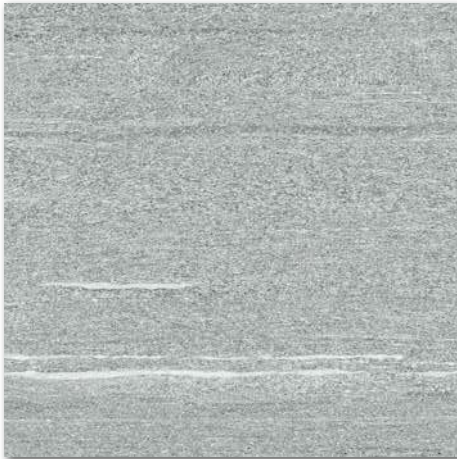

6461-0300 / DAK62847  
 PEI 4 ○ 80 l m<sup>2</sup>  
 mat | matt  
 color **natural**  
 gri / grey

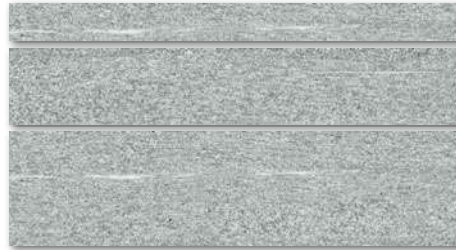

DAKSV847  
 PEI 4 ○ 94 l m<sup>2</sup>  
 mat | matt

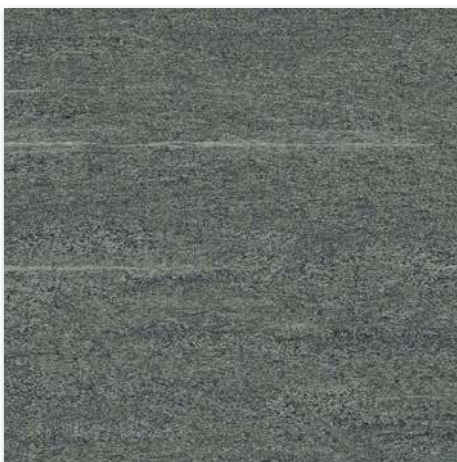

6461-0301 / DAK62848  
 PEI 4 ○ 80 l m<sup>2</sup>  
 mat | matt  
 color **pepper**  
 gri închis / dark grey

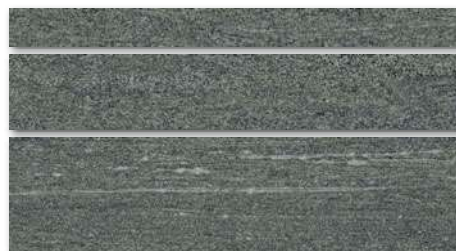



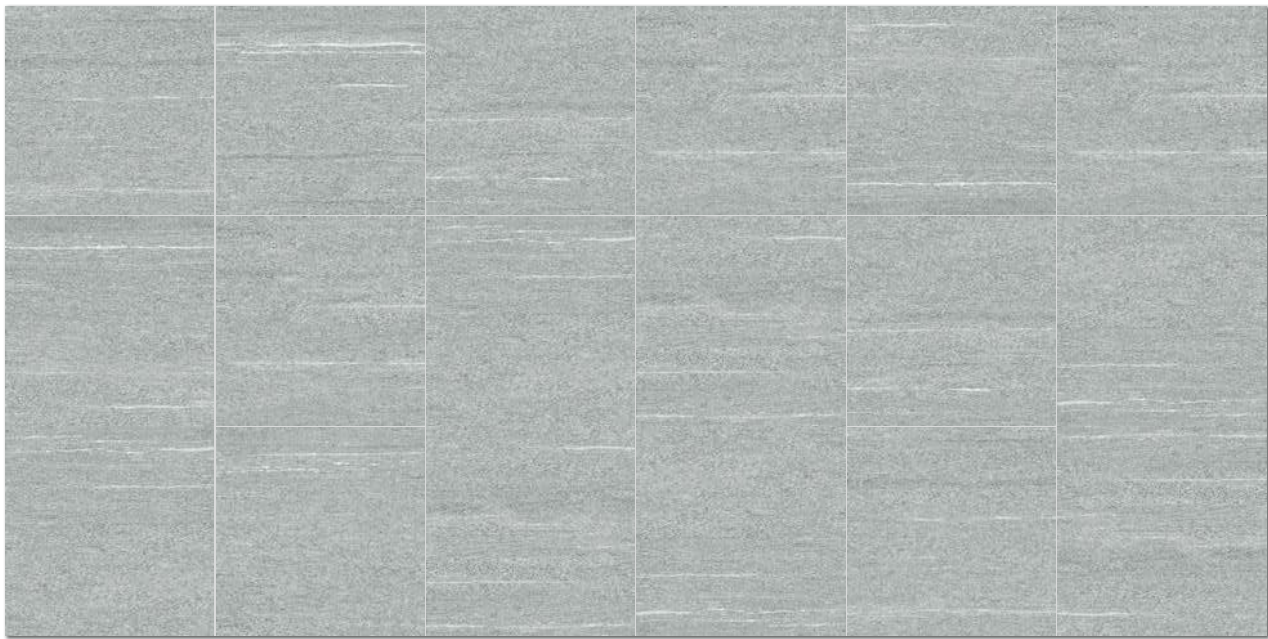







DAKSV848  
 PEI 4 ○ 94 l m<sup>2</sup>  
 mat / matt





Înainte de a monta plăcile, vă sugerăm să selectați din mai multe cutii, să amestecați plăcile (inclusiv prin rotirea lor cu 180°) și să le aranjați așa cum este ilustrat în fotografia de inspirație sau să consultați site-ul [www.cesarom.ro](http://www.cesarom.ro).

Before laying the tiles, we suggest you select from several cartons and arrange them as illustrated in the inspiration photo documentation in RAKO catalogues or website [www.cesarom.ro](http://www.cesarom.ro).

There are two recommended laying patterns to choose from: one is a strictly one-way oriented design, and the other resembles a chessboard look achieved through a regular 90° turn tiling pattern.

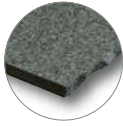
produs / product										
mozaic set 30x30 cm / mosaic sheet 30x30 cm	5x5	48x48x9	EN 14411 - G Bla	3	11	0,27	-	5,2	19,2	-
treaptă / step tile	30x120	298x1198x10	STO č. 030 - 059824	3	2,8	1,08	-	24,6	22,7	-
treaptă / step tile	60x60	598x597x9	STO č. 030 - 059824	3	2,8	1,08	-	20,7	19,2	-
plintă / skirting plinth	60x7,2	598x72x9	STO č. 030 - 059824	14	23,1	0,60	-	11,5	19,2	-
treaptă specială / special step tile	30x120	298x1198x10	STO č. 030 - 059824	2	-	-	-	-	-	-



DDM05846 (SET)  
PEI 5  72 | set  
mat | matt  
color **fog**  
gri deschis / light grey

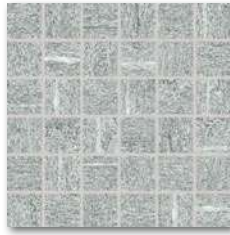

DDM05847 (SET)  
PEI 4  72 | set  
mat | matt  
color **natural**  
gri / grey



DDM05848 (SET)  
PEI 4  72 | set  
mat | matt  
color **pepper**  
gri închis / dark grey



5x5 | 30x30

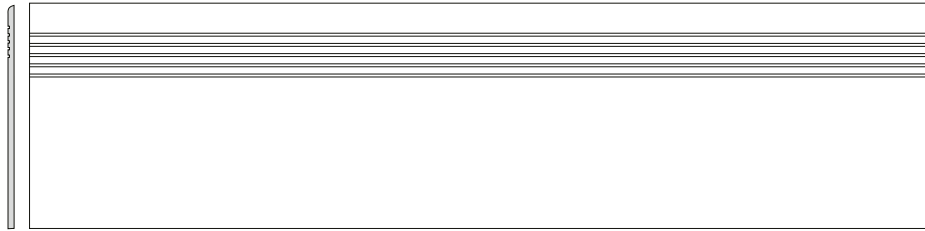
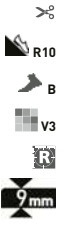

DCPVF846 color **fog** | gri deschis / grey-white  
DCPVF847 color **natural** | gri / grey  
DCPVF848 color **pepper** | gri închis / dark grey  
PEI 4-5  86 | ks  
mat | matt



DCP62846 color **fog** | gri deschis / grey-white  
DCP62847 color **natural** | gri / grey  
DCP62848 color **pepper** | gri închis / dark grey  
PEI 4-5  76 | ks  
mat | matt



DSAS3846 color **fog** | gri deschis / grey-white  
DSAS3847 color **natural** | gri / grey  
DSAS3848 color **pepper** | gri închis / dark grey  
 56 | ks  
mat | matt

30x120

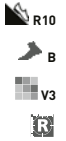

60x60  
60x7,2

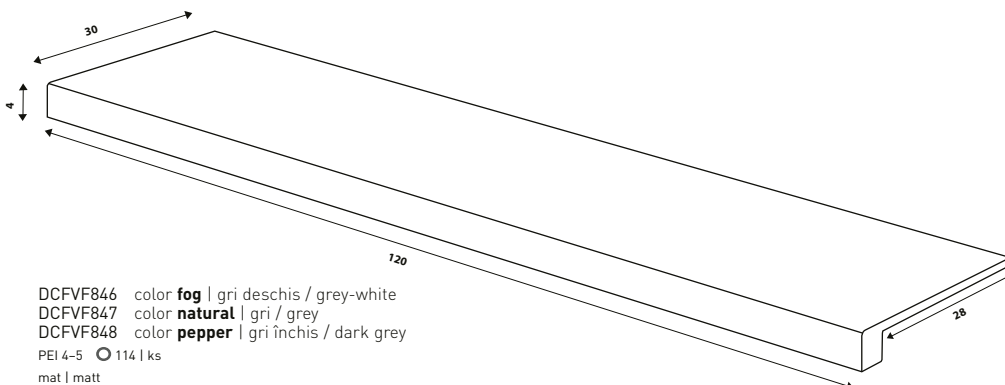

DCFVF846 color **fog** | gri deschis / grey-white  
DCFVF847 color **natural** | gri / grey  
DCFVF848 color **pepper** | gri închis / dark grey  
PEI 4-5  114 | ks  
mat | matt

30x120



News

Home

RAKO

# vals outdoor





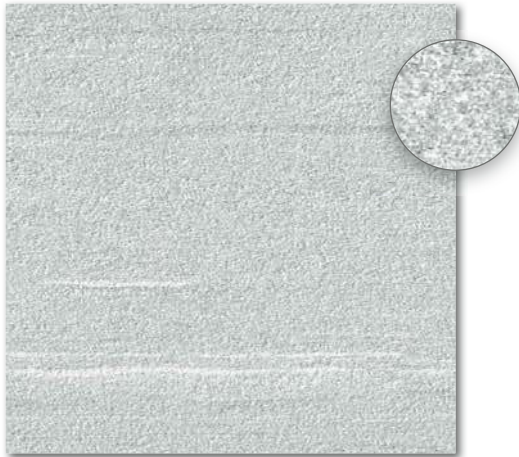
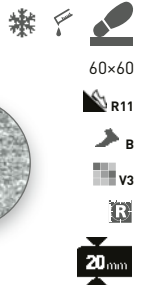

6461-0316 / DAR66846  
 PEI 5 ○ 89 | m<sup>2</sup>  
 mat | matt  
 color **fog**  
 gri deschis / light grey

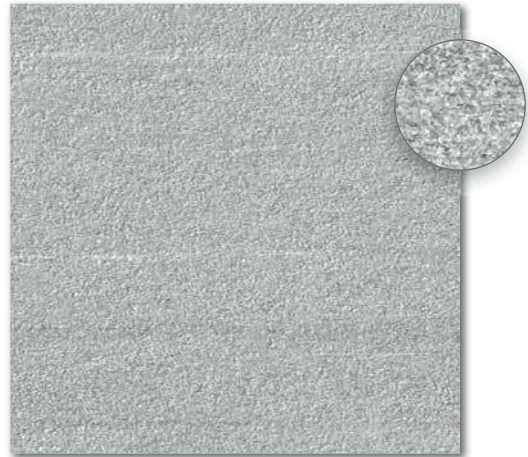

6461-0317 / DAR66847  
 PEI 4 ○ 89 | m<sup>2</sup>  
 mat | matt  
 color **natural**  
 gri / grey

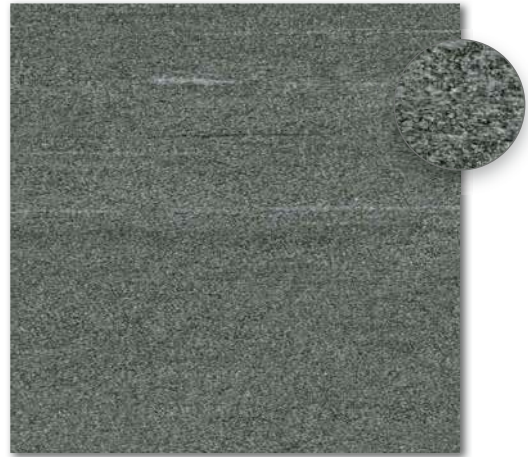

6461-0318 / DAR66848  
 PEI 4 ○ 89 | m<sup>2</sup>  
 mat | matt  
 color **pepper**  
 gri închis / dark grey

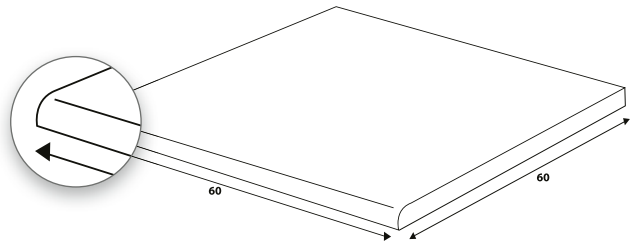

DCH66846 color **fog** | gri deschis / grey-white  
 DCH66847 color **natural** | gri / grey  
 DCH66848 color **pepper** | gri închis / dark grey  
 PEI 4-5 ○ 92 | ks  
 mat | matt

produs / product	cm	mm	EN	ks/m <sup>2</sup>	m <sup>2</sup>	kg	kg/m <sup>2</sup>	brutto kg			
gresie porțelanată / porcelain tile	60x60	598x598x20	EN 14411 - G Bla	2	2,8	0,72	30	21,60	32,0	44,4	985
treaptă / step tile	60x60	598x598x20	STO c. 030 - 059824	2	-	-	-	-	32,0	-	-

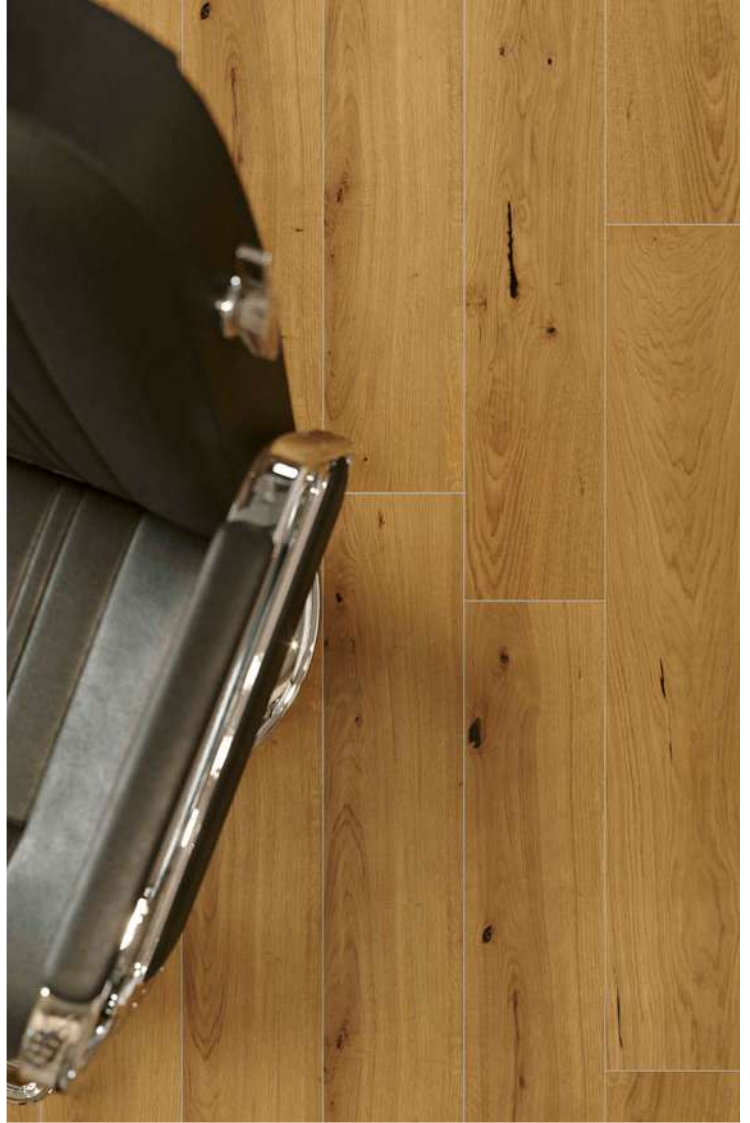



News

Home

**RAKO**





60x120  
20x120



6493-0055 / DAKV1850  
PEI 5  87 l m<sup>2</sup>  
mat | matt



6494-0010 / DAKVG850  
PEI 5  87 l m<sup>2</sup>  
mat | matt  
color **ale**  
bej / beige



6493-0056 / DAKV1851  
PEI 4  87 l m<sup>2</sup>  
mat | matt



6494-0011 / DAKVG851  
PEI 4  87 l m<sup>2</sup>  
mat | matt  
color **cognac**  
maro / brown

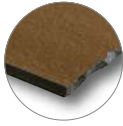

6493-0057 / DAKV1852  
PEI 4  87 | m<sup>2</sup>  
mat | matt



6494-0012 / DAKVG852  
PEI 4  87 | m<sup>2</sup>  
mat | matt  
color **barrique**  
maro închis / dark brown

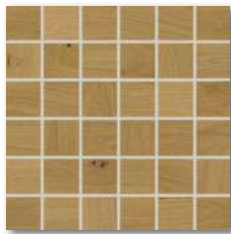

6132-0161 / DDM06850 (SET)  
PEI 5  72 | set  
mat | matt  
color **ale**  
bej / beige

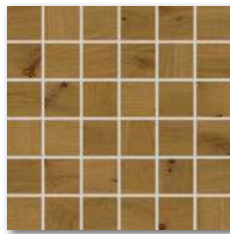

6132-0162 / DDM06851 (SET)  
PEI 4  72 | set  
mat | matt  
color **cognac**  
maro / brown

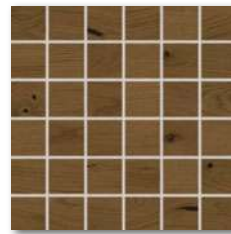

6132-0163 / DDM06852 (SET)  
PEI 4  72 | set  
mat | matt  
color **barrique**  
maro închis / dark brown

5x5 | 30x30



News

Home

**RAKO**

produs / product





produs / product	L (cm)	W (mm)	EN	cm	ks/m <sup>2</sup>	m <sup>2</sup>	m <sup>2</sup>	m <sup>2</sup>	kg	kg/m <sup>2</sup>	brutto kg
gresie porțelanată / porcelain tile	60x120	598x1198x10	EN 14411 - G Bla	2	1,4	1,44	27	38,88	32,7	22,7	908
gresie porțelanată / porcelain tile	20x120	198x1198x10	EN 14411 - G Bla	4	4,2	0,96	32	30,72	21,8	22,7	723
mozaic set 30x30 cm / mosaic sheet 30x30 cm	5x5	48x48x10	EN 14411 - G Bla	3	11	0,27	-	-	-	-	-



Înainte de a monta plăcile, vă sugerăm să selectați din mai multe cutii, să amestecați plăcile (inclusiv prin rotirea lor cu 180°) și să le aranjați așa cum este ilustrat în fotografia de inspirație sau să consultați site-ul [www.cesarom.ro](http://www.cesarom.ro).

Before laying the tiles, we suggest you select from several cartons and arrange them as illustrated in the inspiration photo documentation in RAKO catalogues or website [www.cesarom.ro](http://www.cesarom.ro). There are two recommended laying patterns to choose from: one is a strictly one-way oriented design, and the other resembles a chessboard look achieved through a regular 90° turn tiling pattern.

produs / product										
treaptă / step tile	30x120	298x1198x10	STO ě. 030 - 059824	3	2,8	1,08	-	24,6	22,7	-
plintă / skirting plinth	60x7,2	598x72x10	STO ě. 030 - 059824	13	23,2	0,56	-	12,3	21,9	-
traptă specială / special step tile	30x120	298x1198x10	STO ě. 030 - 059824	2	-	-	-	-	-	-

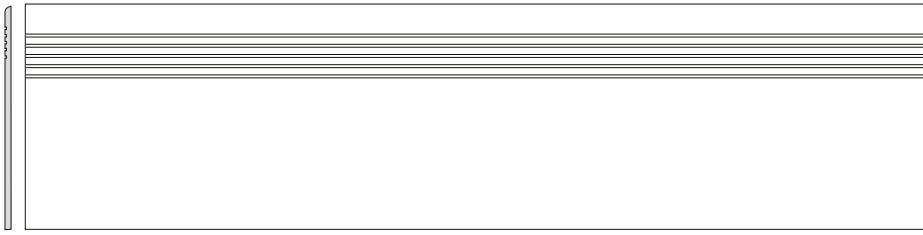
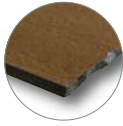

DCPVF850 color **ale** | bej / beige  
 DCPVF851 color **cognac** | maro / brown  
 DCPVF852 color **barrique** | maro închis / dark brown  
 PEI 4-5  86 | ks  
 mat | matt



DSASP850 color **ale** | bej / beige  
 DSASP851 color **cognac** | maro / brown  
 DSASP852 color **barrique** | maro închis | dark brown  
 56 | ks  
 mat | matt

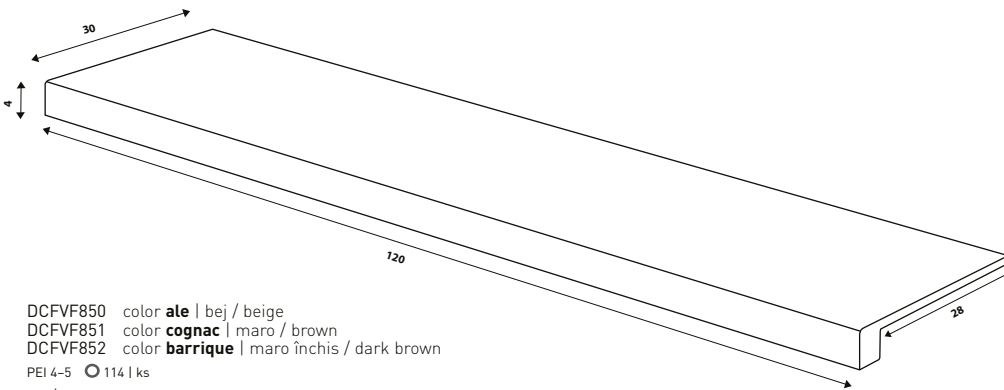

DCFVF850 color **ale** | bej / beige  
 DCFVF851 color **cognac** | maro / brown  
 DCFVF852 color **barrique** | maro închis / dark brown  
 PEI 4-5  114 | ks  
 mat | matt



30x120



60x7,2



30x120



News

Home

**RAKO**

**bricola** outdoor









# plywood



News

Home

**RAKO**

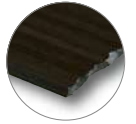

60x120

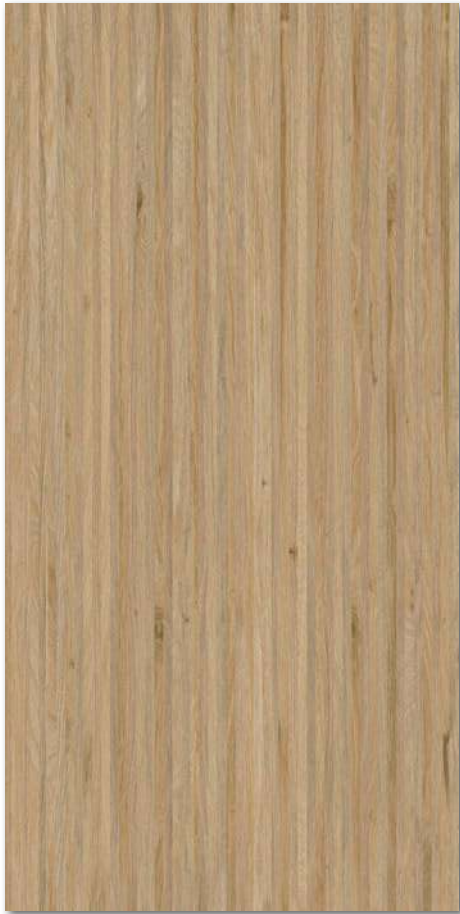

6493-0059 / DAKV1842  
 PEI 5  87 l m<sup>2</sup>  
 mat | matt  
 color **straw**  
 bej | beige



6493-0060 / DAKV1843  
 PEI 4  87 l m<sup>2</sup>  
 mat | matt  
 color **honey**  
 maro / brown



6493-0058 / DAKV1841  
 PEI 5  87 l m<sup>2</sup>  
 mat | matt  
 color **latte**  
 alb | white



6493-0061 / DAKV1844  
 PEI 4  87 l m<sup>2</sup>  
 mat | matt  
 color **burn**  
 maro închis / dark brown

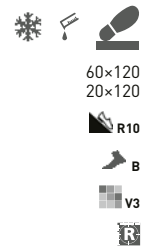
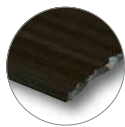

6493-0062 / DAKV1845  
 PEI 4 ○ 90 l m<sup>2</sup>  
 mat | matt  
 color **doppio**  
 multicolor / multicoloured



6494-0014 / DAKVG842  
 PEI 5 ○ 87 l m<sup>2</sup>  
 mat | matt  
 color **straw**  
 bej / beige

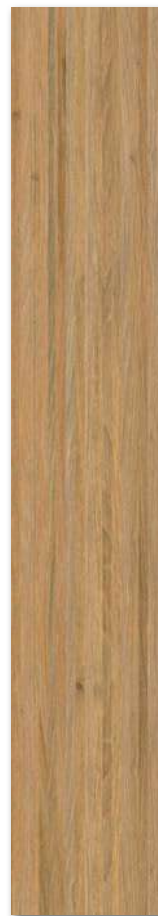

6494-0015 / DAKVG843  
 PEI 4 ○ 87 l m<sup>2</sup>  
 mat | matt  
 color **honey**  
 maro / brown



6494-0013 / DAKVG841  
 PEI 5 ○ 87 l m<sup>2</sup>  
 mat | matt  
 color **latte**  
 alb / white



6494-0016 / DAKVG844  
 PEI 4 ○ 87 l m<sup>2</sup>  
 mat | matt  
 color **burn**  
 maro închis / dark brown

# plywood

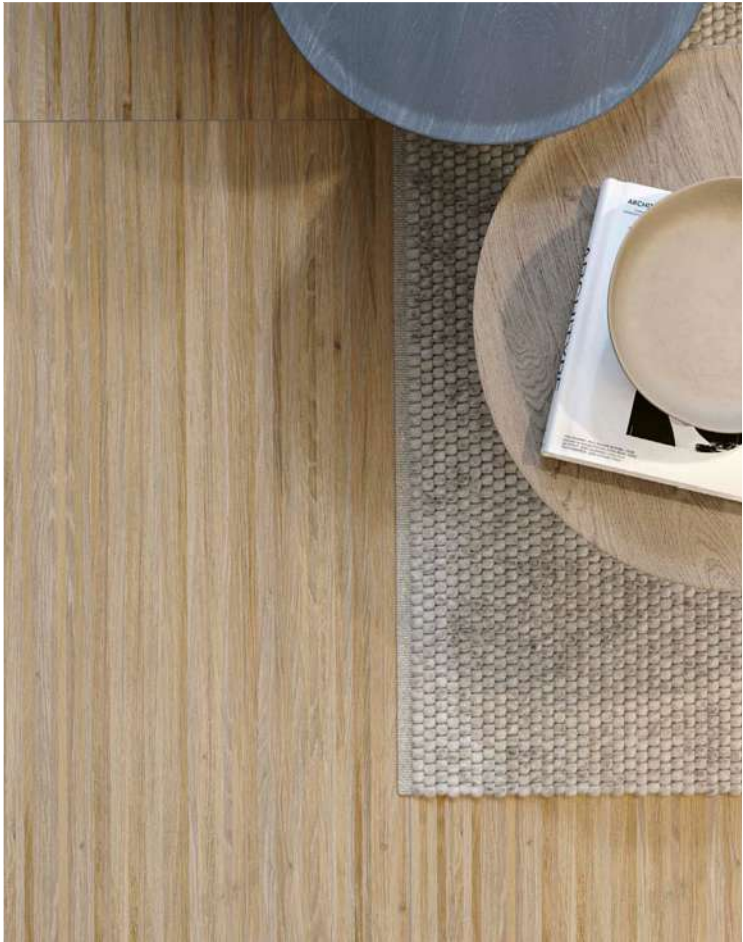

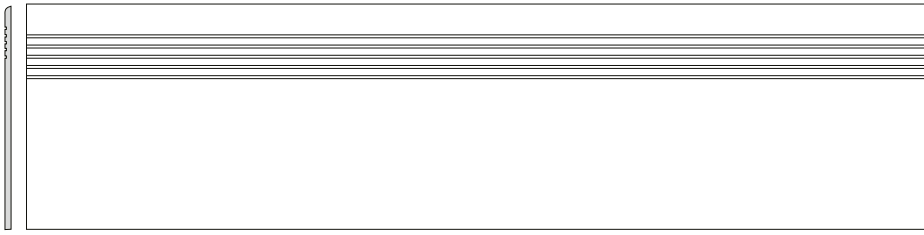
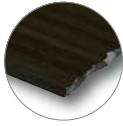

DCPVF841 color **latte** | alb / white  
 DCPVF842 color **straw** | bej / beige  
 DCPVF843 color **honey** | maro / brown  
 DCPVF844 color **burn** | maro închis / dark brown  
 PEI 4-5 ○ 86 | ks  
 mat | matt



DSASP841 color **latte** | alb / white  
 DSASP842 color **straw** | bej / beige  
 DSASP843 color **honey** | maro / brown  
 DSASP844 color **burn** | maro închis / dark brown  
 ○ 56 | ks  
 mat | matt

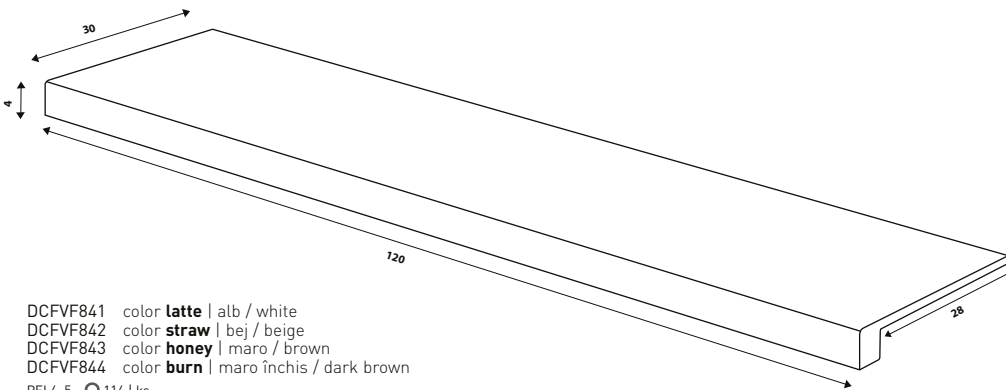

DCFVF841 color **latte** | alb / white  
 DCFVF842 color **straw** | bej / beige  
 DCFVF843 color **honey** | maro / brown  
 DCFVF844 color **burn** | maro închis / dark brown  
 PEI 4-5 ○ 114 | ks  
 mat | matt



30×120



60×7,2











30×120



News

Home

**RAKO**

produs / product											
gresie porțelanată / porcelain tile	60×120	598×1198×10	EN 14411 - G Bla	2	1,4	1,44	27	38,88	32,7	22,7	908
gresie porțelanată / porcelain tile	20×120	198×1198×10	EN 14411 - G Bla	4	4,2	0,96	32	30,72	21,8	22,7	723
treaptă / step tile	30×120	298×1198×10	STO č. 030 - 059824	3	2,8	1,08	-	-	24,6	22,7	-
plintă / skirting plinth	60×7,2	598×72×10	STO č. 030 - 059824	13	23,2	0,56	-	-	12,3	21,9	-
treaptă specială / special step tile	30×120	298×1198×10	STO č. 030 - 059824	2	-	-	-	-	-	-	-









120x120

R10

B

V3



6498-0101 / DAK92790  
PEI 5  102 | m<sup>2</sup>  
mat | matt  
alb-gri / white-grey



6498-0102 / DAK92791  
PEI 4  102 | m<sup>2</sup>  
mat | matt  
gri / grey

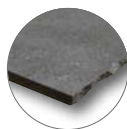

120x120



B



6498-0104 / DAK92793

PEI 5 ○ 102 | m<sup>2</sup>

mat | matt

bej deschis / light beige



6498-0103 / DAK92792

PEI 4 ○ 102 | m<sup>2</sup>

mat | matt

negru / black

News

Home

**RAKO**



60x120

R10

B

V3

R

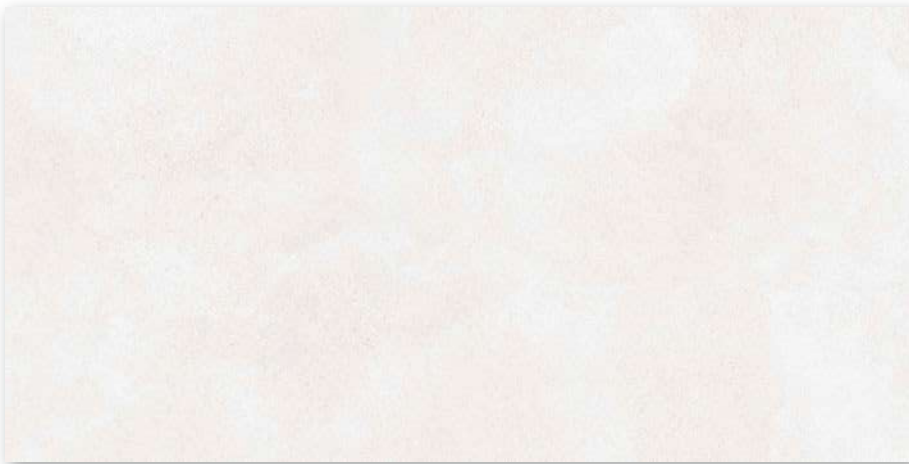

6493-0046 / DAKV1790

PEI 5  
mat | matt

alb-gri / white-gray



6493-0043 / DAKV1791

PEI 4  
mat | matt

gri / gray



6493-0044 / DAKV1792

PEI 4  
mat | matt

negru / black

produs / product



EN



pcs/m<sup>2</sup>

m<sup>2</sup>



kg

kg/m<sup>2</sup>

brutto kg

produs / product	cm	mm	EN	mm	pcs/m <sup>2</sup>	m <sup>2</sup>	kg	kg/m <sup>2</sup>	brutto kg		
gresie porțelanată / porcelain tile	120x120	1198x1198x10	EN 14411-2016, annex G Bla GL	2	0,7	2,88	18	51,84	57,6	20,0	1077
gresie porțelanată / porcelain tile	60x120	598x1198x10	EN 14411-2016, annex G Bla GL	2	1,4	1,44	27	38,88	32,7	22,7	908
treaptă / step tile	30x120	298x1198x10	STO € 030 - 059824	5	2,8	1,80	-	-	40,9	22,7	-
plintă / skirting plinth	120x7	1198x70x10	STO € 030 - 059824	10	11,9	0,84	-	-	19,1	22,7	-

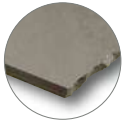

6493-0045 / DAKV1793  
PEI 5  
mat | matt  
bej deschis / light beige



6493-0040 / DAKV1794  
PEI 4  
mat | matt  
bej închis / dark beige

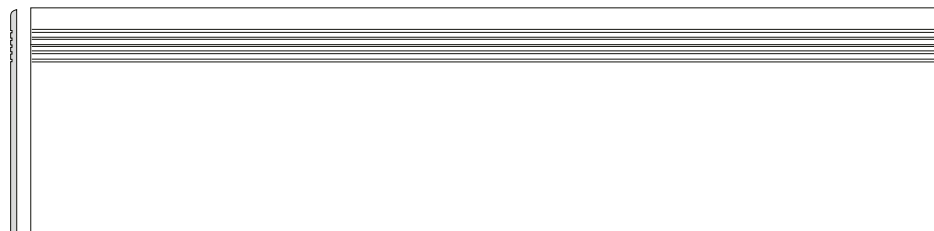

6895-0030 / DCPVF790 alb-gri / white-gray  
6895-0006 / DCPVF791 gri / gray  
6895-0027 / DCPVF792 negru / black  
6895-0029 / DCPVF793 bej deschis / light beige  
6895-0002 / DCPVF794 bej închis / dark beige  
mat | matt



6709-0101 / DSA97790 alb-gri / white-gray  
6709-0102 / DSA97791 gri / gray  
6709-0103 / DSA97792 negru / black  
6709-0104 / DSA97793 bej deschis / light beige  
6709-0105 / DSA97794 bej închis / dark beige  
mat | matt

60x120



30x120



120x7





6461-0232 / DAK63795  
 PEI 5 ○ 88 | m²  
 mat | matt | ■ V4  
 alb-gri / white-grey



6461-0236 / DAK63796  
 PEI 4 ○ 88 | m²  
 mat | matt | ■ V4  
 gri / grey



6461-0235 / DAK63797  
 PEI 5 ○ 88 | m²  
 mat | matt | ■ V4  
 bej / beige

produs / product



gresie portelanată / porcelain tile  
 gresie portelanată / porcelain tile

60×60  
 60×120

598×598×10  
 598×1198×10

EN 14411 - G Bla  
 EN 14411 - G Bla

3  
 2

2,8  
 1,4

1,08  
 1,44

32  
 27

34,56  
 38,88

23,7  
 32,7

21,9  
 22,7

782  
 908

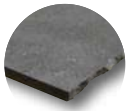

60×60  
60×120

R10

B

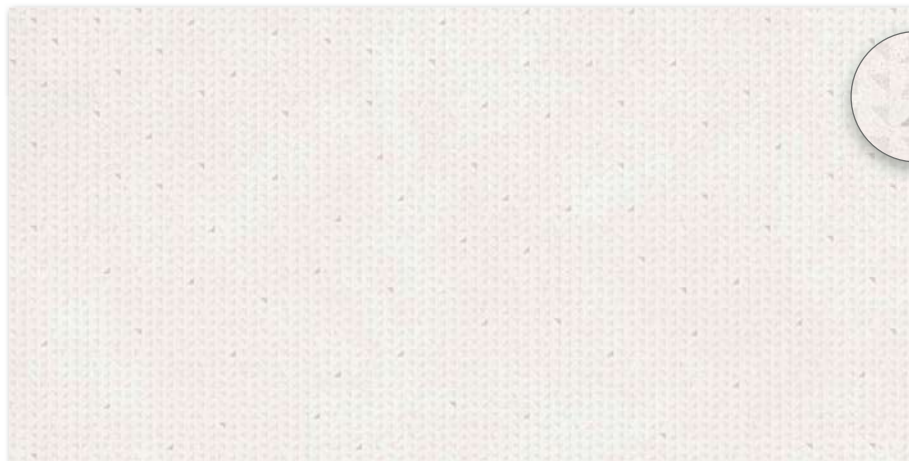

6493-0033 / DAKV1795  
PEI 5 ○ 90 l m<sup>2</sup>  
mat | matt | ■ V3  
alb-gri / white-grey

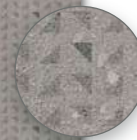
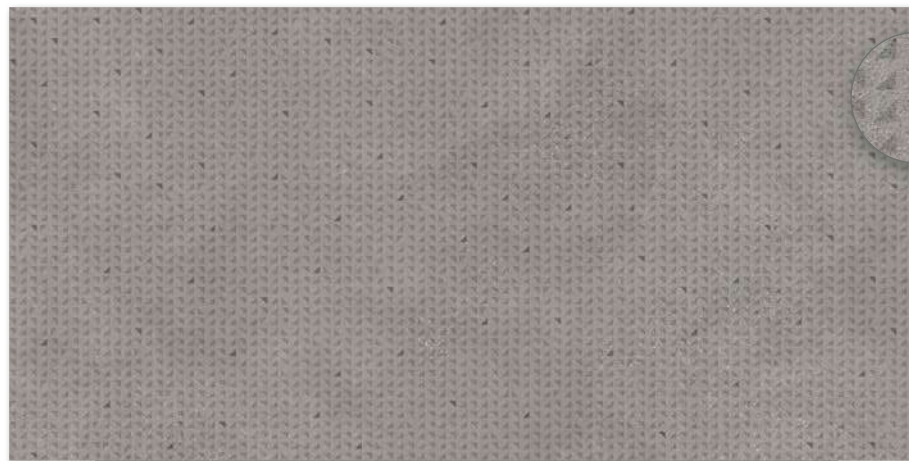

6493-0034 / DAKV1796  
PEI 4 ○ 90 l m<sup>2</sup>  
mat | matt | ■ V3  
gri / grey



6493-0035 / DAKV1797  
PEI 5 ○ 90 l m<sup>2</sup>  
mat | matt | ■ V3  
bej / beige

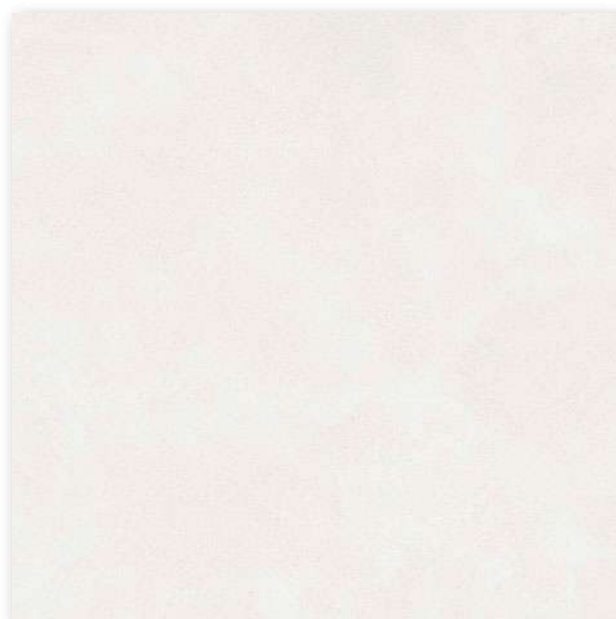

6485-0021 / DAK81790  
 PEI 5  
 mat | matt  
 alb-gri / white-gray

produs / product



gresie porțelanată / porcelain tile  
 plintă / skirting plinth

80×80  
 80×9,5

798×798×10  
 798×95×10

EN 14411:2016, anex G Bla GL  
 STO ě. 030 - 059824

2  
 10

1,6  
 13,2

1,28  
 0,76

42  
 -

53,76  
 -

28,0  
 16,7

21,9  
 21,9

1 202  
 -



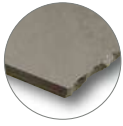

6485-0023 / DAK81791  
PEI 4  
mat | matt  
gri / gray



6485-0020 / DAK81792  
PEI 4  
mat | matt  
negru / black

80x80



6485-0024 / DAK81793  
PEI 5  
mat | matt  
bej deschis / light beige



6485-0018 / DAK81794  
PEI 4  
mat | matt  
bej închis / dark beige

RAKO Home



80x9.5



6708-0016 / DSA89790 alb-gri / white-gray  
6708-0017 / DSA89791 gri / gray  
6708-0018 / DSA89792 negru / black  
6708-0019 / DSA89793 bej deschis / light beige  
6708-0020 / DSA89794 bej închis / dark beige  
mat | matt



60x60

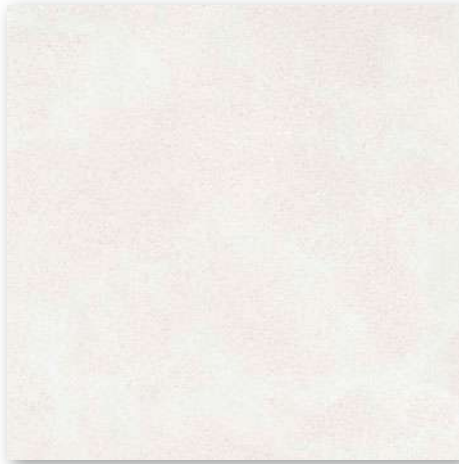

6461-0230 / DAK63790  
PEI 5 R10 mat | matt  
alb-gri / white-gray

6461-0270 / DAF63790  
PEI 5 R11 mat | matt  
alb-gri / white-gray



6461-0228 / DAK63793  
PEI 5 R10 mat | matt  
bej deschis / light beige

6461-0274 / DAF63793  
PEI 5 R11 mat | matt  
bej deschis / light beige

30x30

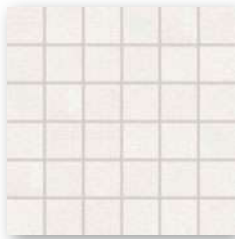

6100-0083 / DDM06790  
PEI 5 mat | matt alb-gri / white-gray

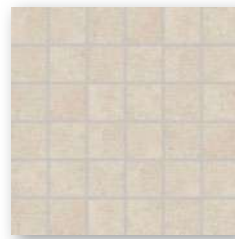

6100-0099 / DDM06793  
PEI 5 mat | matt bej deschis / light beige

60x60



6461-0231 / DAK63791  
PEI 4 R10 mat | matt  
gri / gray

6461-0272 / DAF63791  
PEI 4 R11 mat | matt  
gri / gray



6461-0237 / DAK63792  
PEI 4 R10 mat | matt  
negru / black

6461-0273 / DAF63792  
PEI 4 R11 mat | matt  
negru / black

30x30

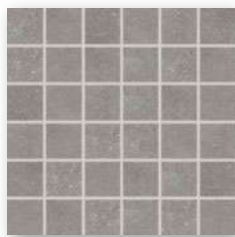

6100-0103 / DDM06791  
PEI 4 mat | matt gri / gray

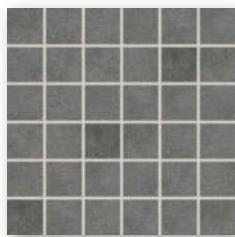

6100-0098 / DDM06792  
PEI 4 mat | matt negru / black

produs / product



EN



pcs/m<sup>2</sup>



kg/m<sup>2</sup>



kg



kg/m<sup>2</sup>



brutto kg

produs / product	cm	mm	EN	pcs/m <sup>2</sup>	kg/m <sup>2</sup>	kg	kg/m <sup>2</sup>	brutto kg
gresie portelanată / porcelain tile	60x60	598x598x10	EN 14411-2016, annex G Bla GL	3	2,8	1,08	32	34,56
treaptă / step tile	30x60	298x598x10	STO ě. 030 - 059824	6	5,6	1,08	40	-
plintă / skirting plinth	60x9,5	598x95x10	STO ě. 030 - 059824	13	17,5	0,74	-	16,2
mozaic / mosaic sheet 30x30 cm	5x5	48x48x10	EN 14411-2016, annex G Bla GL	3	11	0,27	-	5,9

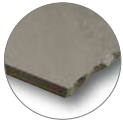

6461-0239 / DAK63794  
PEI 4 R10 mat | matt  
bej închis / dark beige

6461-0275 / DAF63794  
PEI 4 R11 mat | matt  
bej închis / dark beige



6100-0104 / DDM06794  
PEI 4 mat | matt bej închis / dark beige

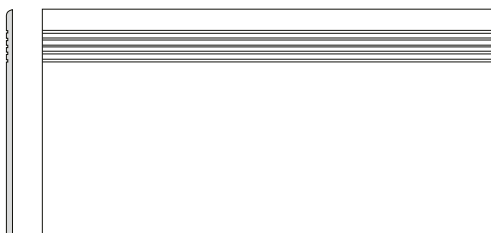

30x60



6860-0048 / DCPSE790 alb-gri / white-gray  
6860-0041 / DCPSE791 gri / gray  
6860-0057 / DCPSE792 negru / black  
6860-0039 / DCPSE793 bej deschis / light beige  
6860-0056 / DCPSE794 bej închis / dark beige  
PEI 4-5  
mat | matt



60x9,5



6706-0088 / DSAS4790 alb-gri / white-gray  
6706-0083 / DSAS4791 gri / gray  
6706-0109 / DSAS4792 negru / black  
6706-0071 / DSAS4793 bej deschis / light beige  
6706-0110 / DSAS4794 bej închis / dark beige  
mat | matt



Înainte de a monta plăcile, vă sugerăm să selectați din mai multe cutii, să amestecați plăcile (inclusiv prin rotirea lor cu 180°) și să le aranjați așa cum este ilustrat în fotografia de inspirație sau să consultați site-ul [www.cesarom.ro](http://www.cesarom.ro).

Before laying the tiles, we suggest you select from several cartons and arrange them as illustrated in the inspiration photo documentation in RAKO catalogues or website [www.cesarom.ro](http://www.cesarom.ro).

There are two recommended laying patterns to choose from: one is a strictly one-way oriented design, and the other resembles a chessboard look achieved through a regular 90° turn tiling pattern.



produs / product



60x60  
60x60



598x598x20  
598x598x20

EN

EN 14411 - G B1a  
STO č. 030 - 059824



2  
2



2,8



0,72



30



21,60



32,0  
32,0



44,4



985

gresie portelanată / porcelain tile  
treaptă / step tile

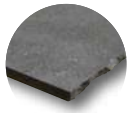

60x60

R11

B

V3

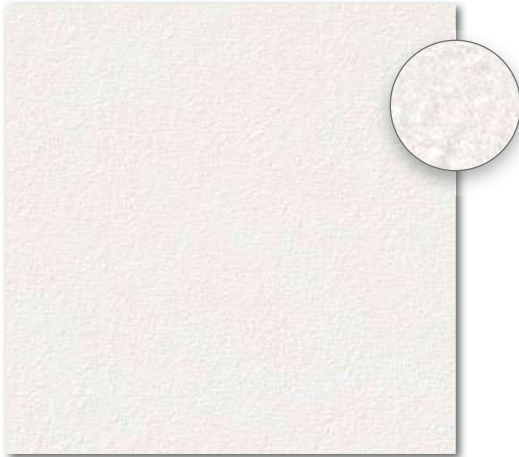

6461-0306 / DAR66790  
PEI 5 ○ 89 | m<sup>2</sup>  
mat | matt  
alb-gri / white-grey



6461-0309 / DAR66793  
PEI 5 ○ 89 | m<sup>2</sup>  
mat | matt  
bej deschis / light beige



6461-0307 / DAR66791  
PEI 4 ○ 89 | m<sup>2</sup>  
mat | matt  
gri / grey



6461-0310 / DAR66794  
PEI 4 ○ 89 | m<sup>2</sup>  
mat | matt  
bej închis / dark beige



6461-0308 / DAR66792  
PEI 4 ○ 89 | m<sup>2</sup>  
mat | matt  
negru / black

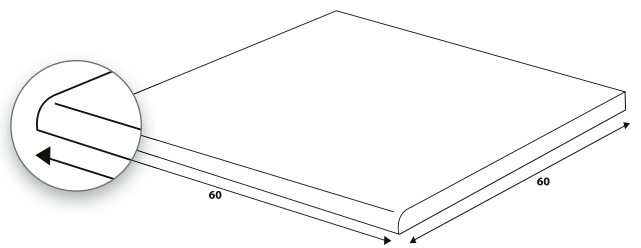

DCH66790 alb-gri / white-grey  
DCH66791 gri / grey  
DCH66792 negru / black  
DCH66793 bej deschis / light beige  
DCH66794 bej închis / dark beige  
PEI 4-5 ○ 92 | ks  
mat | matt







60x120

 R10

 B

 V3

 R



6493-0016 / DARV1722

PEI 5  
mat | matt  
alb / white



6493-0014 / DARV1720

PEI 5  
mat | matt  
ivoriu / ivory



6493-0015 / DARV1721

PEI 4  
mat | matt  
maro-gri / brown-gray

produs / product



EN



pcs/m<sup>2</sup>



m<sup>2</sup>



kg/m<sup>2</sup>



brutto kg





60x120

 R10

 B

 V3

 R

6493-0017 / DARV1723  
PEI 4  
mat | matt  
gri deschis / light gray



6493-0018 / DARV1724  
PEI 4  
mat | matt  
gri închis / dark gray



6493-0019 / DARV1725  
PEI 4  
mat | matt  
negru / black

Înainte de a monta plăcile, vă sugerăm să selectați din mai multe cutii, să amestecați plăcile (inclusiv prin rotirea lor cu 180°) și să le aranjați așa cum este ilustrat în fotografia de inspirație sau să consultați site-ul [www.cesarom.ro](http://www.cesarom.ro).

Before laying the tiles, we suggest you select from several cartons and arrange them as illustrated in the inspiration photo documentation in RAKO catalogues or website [www.cesarom.ro](http://www.cesarom.ro). There are two recommended laying patterns to choose from: one is a strictly one-way oriented design, and the other resembles a chessboard look achieved through a regular 90° turn tiling pattern.

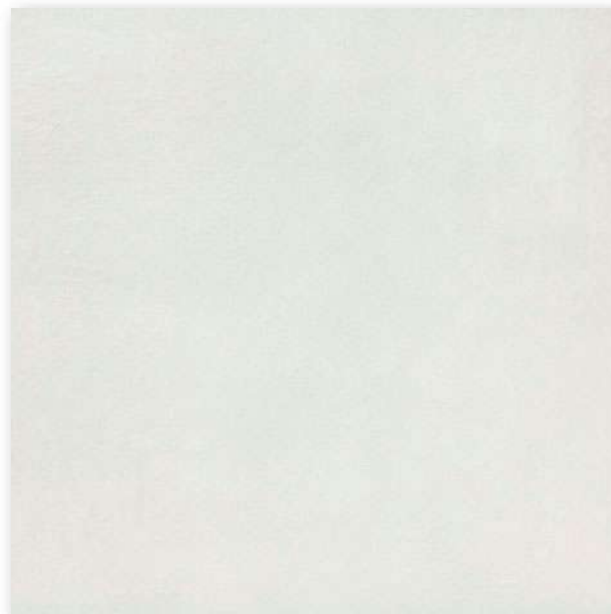

6485-0002 / DAR81722  
PEI 5  
mat | matt  
alb / white

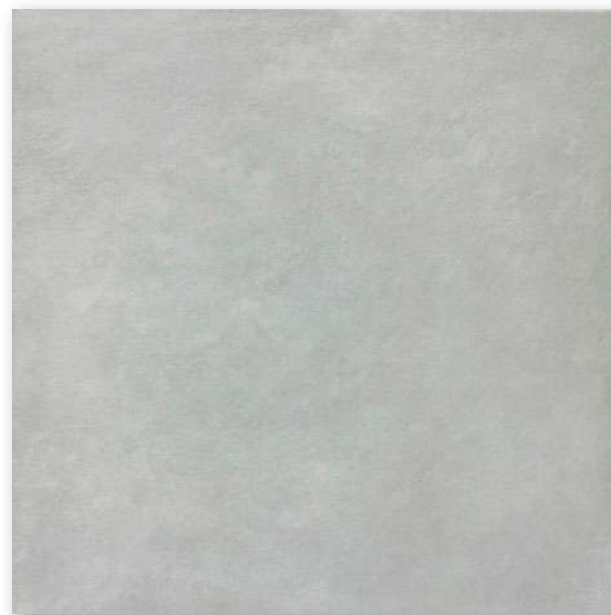

6485-0003 / DAR81723  
PEI 4  
mat | matt  
gri deschis / light gray

produs / product



gresie porțelanată / porcelain tile  
plintă / skirting plinth

80×80  
80×9,5

798×798×10  
798×95×10

EN 14411:2016, anex G Bla GL  
STO E. 030 - 059824

2  
10

1,6  
13,2

1,28  
0,76

42  
-

53,76  
-

28,0  
16,7

21,9  
21,9

1 202  
-

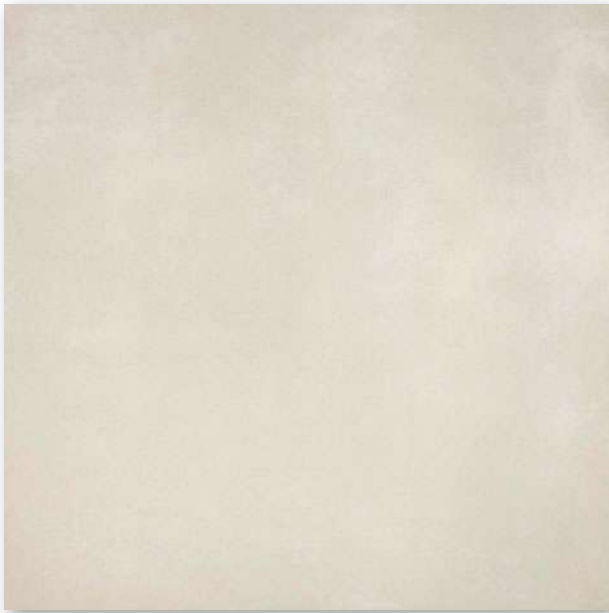
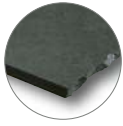

6485-0025 / DAR81720  
PEI 5  
mat | matt  
ivoriu | ivory

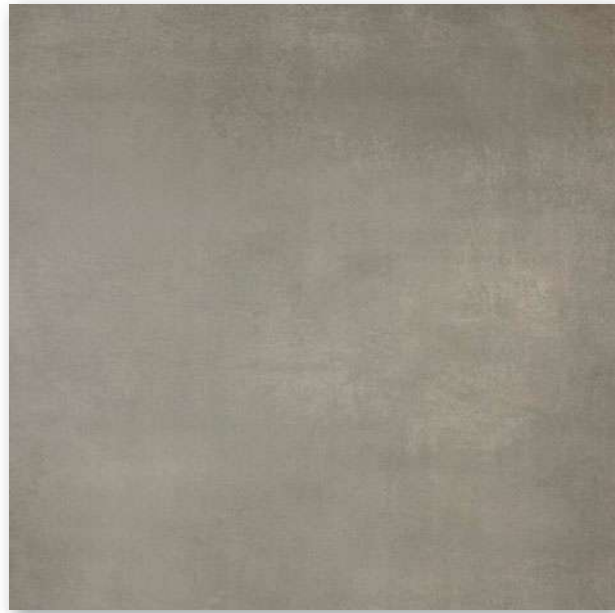

6485-0001 / DAR81721  
PEI 4  
mat | matt  
maro-gri / brown-gray

80x80  
R10  
B  
V3  
R



6485-0004 / DAR81724  
PEI 4  
mat | matt  
gri / gray

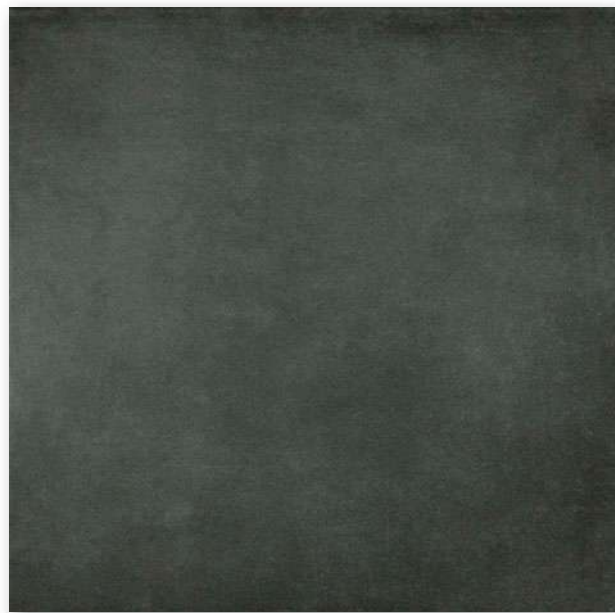

6485-0005 / DAR81725  
PEI 4  
mat | matt  
negru / black



6708-0001 / DSA89720 ivoriu / ivory  
6708-0002 / DSA89721 maro-gri / brown-gray  
6708-0003 / DSA89722 alb / white  
6708-0004 / DSA89723 gri deschis / light gray  
6708-0005 / DSA89724 gri / gray  
6708-0006 / DSA89725 negru / black  
mat | matt

80x9.5  
V3  
R



60x60

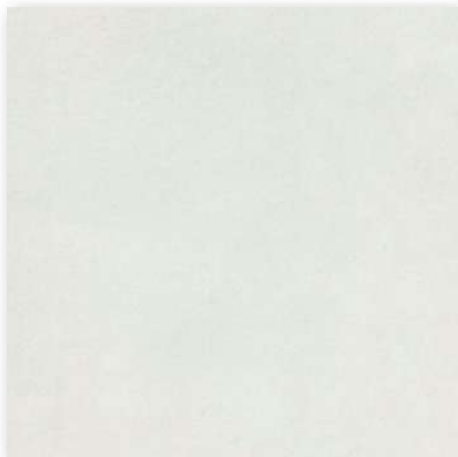

6461-0169 / DAR63722  
PEI 5 mat | matt alb / white



6461-0167 / DAR63720  
PEI 5 mat | matt ivoriu / ivory

30x45



6604-0051 / DDVP4722  
PEI 5 mat | matt alb / white



6604-0052 / DDVP4720  
PEI 5 mat | matt ivoriu / ivory

60x60

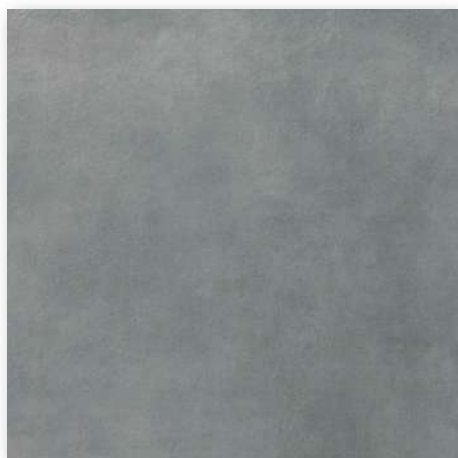

6461-0171 / DAR63724  
PEI 4 mat | matt gri închis / dark gray



6461-0172 / DAR63725  
PEI 4 mat | matt negru / black

30x45



6604-0055 / DDVP4724  
PEI 4 mat | matt gri închis / dark gray

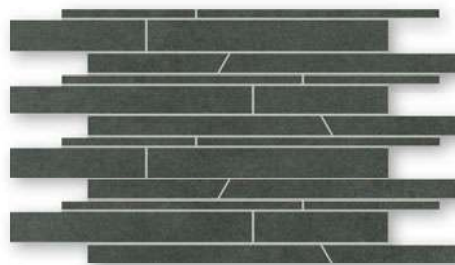

6604-0056 / DDVP4725  
PEI 4 mat | matt negru / black

produs / product



produs / product	60x60	30x45	30x120	30x60	60x9,5	598x598x10	298x445x8	298x1198x10	298x598x10	598x95x10	EN	3	5	5	6	13	2,8	7,4	2,8	5,6	17,5	1,08	0,68	1,80	1,08	0,74	32	36	-	40	-	23,7	10,5	40,9	23,7	16,2	21,9	17,4	22,7	21,9	21,9	782	-	-	-	-			
gresie porțelanată / porcelain tile																																																	
decor (set) / decor (sheet)																																																	
treaptă / step tile																																																	
treaptă / step tile																																																	
plintă / skirting plinth																																																	

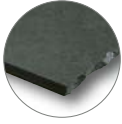

6461-0168 / DAR63721  
PEI 4 mat | matt maro-gri / brown-gray



6604-0053 / DDVP4721  
PEI 4 mat | matt maro-gri / brown-gray



6461-0170 / DAR63723  
PEI 4 mat | matt gri deschis / light gray



6604-0054 / DDVP4723  
PEI 4 mat | matt gri deschis / light gray



6895-0009 / DCPVF722 alb / white  
6895-0008 / DCPVF720 ivoriu / ivory  
6895-0003 / DCPVF723 gri deschis / light gray  
6895-0010 / DCPVF724 gri închis / dark gray

6895-0012 / DCPVF725 negru / black  
6895-0011 / DCPVF721 maro-gri / brown-gray  
PEI 4-5  
mat | matt



RAKO Home

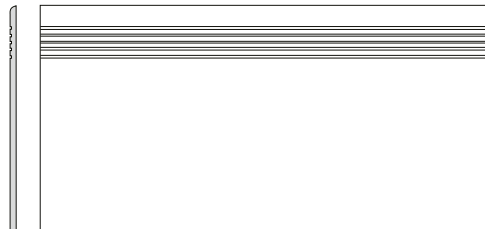

6860-0053 / DCPSE722 alb / white  
6860-0020 / DCPSE720 ivoriu / ivory  
6860-0021 / DCPSE723 gri deschis / light gray  
6860-0025 / DCPSE724 gri închis / dark gray  
6860-0026 / DCPSE725 negru / black  
6860-0050 / DCPSE721 maro-gri / brown-gray  
PEI 4-5  
mat | matt



6706-0095 / DSAS4720 ivoriu / ivory  
6706-0096 / DSAS4721 maro-gri / brown-gray  
6706-0097 / DSAS4722 alb / white  
6706-0089 / DSAS4723 gri deschis / light gray  
6706-0060 / DSAS4724 gri închis / dark gray  
6706-0098 / DSAS4725 negru / black  
mat | matt





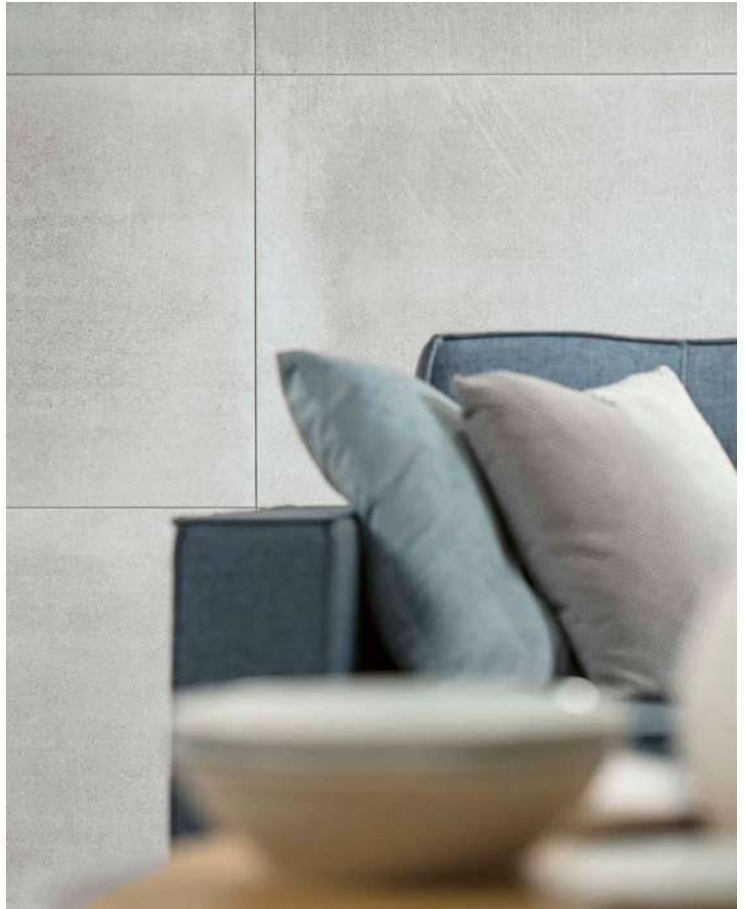



60x120

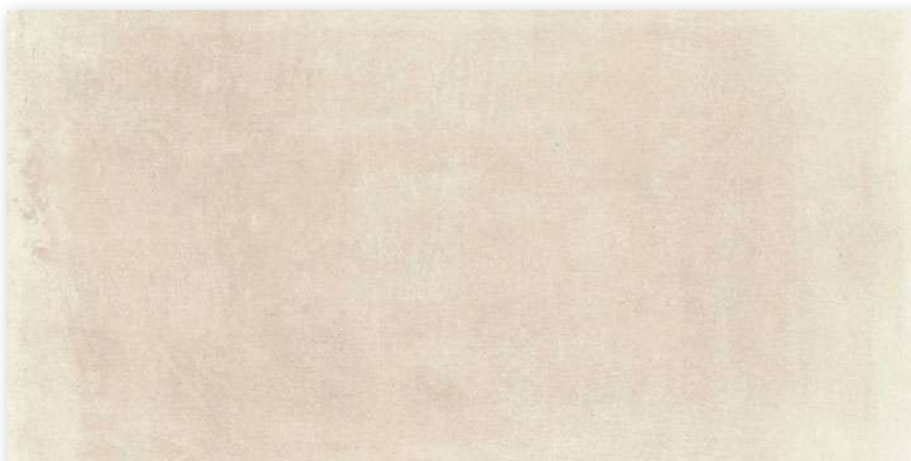

6493-0010 / DAKV1743

PEI 5  
mat | matt  
bej / beige

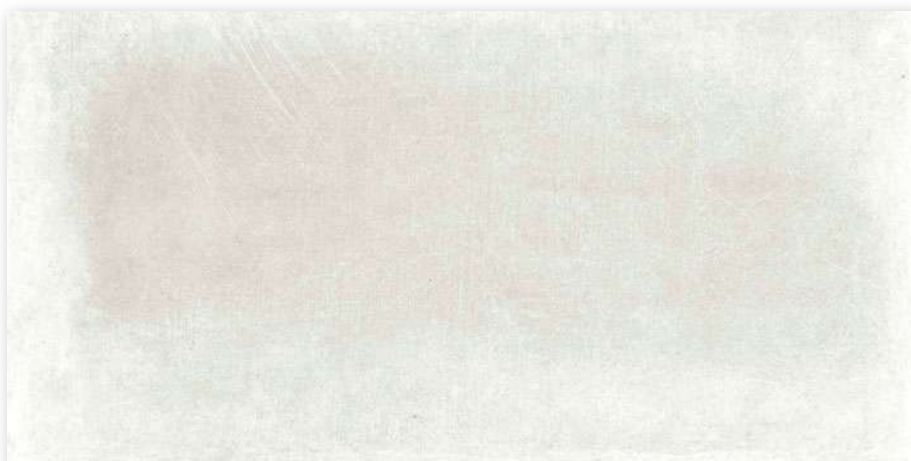

6493-0007 / DAKV1740

PEI 5  
mat | matt  
alb-gri / white-gray

produs / product



gresie porțelanată / porcelain tile  
treaptă / step tile

60×120  
30×120

598×1198×10  
298×1198×10

EN 14411:2016, anex G Bla GL  
STO č. 030 - 059824

2  
5

1,4  
2,8

1,44  
1,80

27  
-

38,88  
-

32,7  
40,9

22,7  
22,7

908  
-



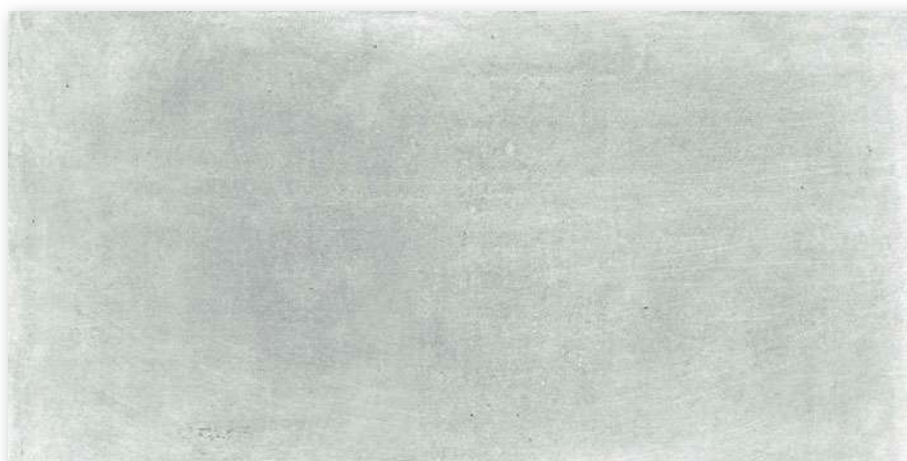
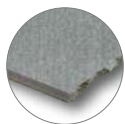

60x120



6493-0008 / DAKV1741  
PEI 5  
mat | matt  
gri / gray

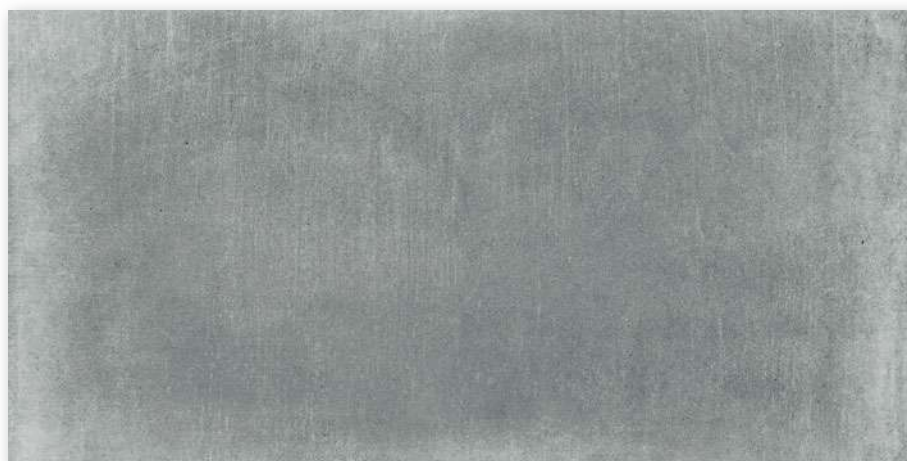

6493-0009 / DAKV1742  
PEI 4  
mat | matt  
gri închis / dark gray

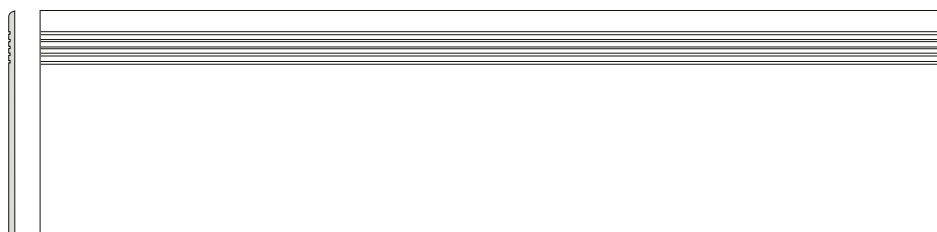

30x120



6895-0016 / DCPVF740 alb-gri / white-grey  
6895-0017 / DCPVF741 gri / gray  
6895-0018 / DCPVF742 gri închis / dark gray  
6895-0019 / DCPVF743 bej / beige  
PEI 4-5  
mat | matt

Toate plăcile unui lot prezintă variații intenționate de nuanță. / All products of the entire batch show big deviations in shade difference.

Înainte de a monta plăcile, vă sugerăm să selectați din mai multe cutii, să amestecați plăcile (inclusiv prin rotirea lor cu 180°) și să le aranjați așa cum este ilustrat în fotografia de inspirație sau să consultați site-ul [www.cesarom.ro](http://www.cesarom.ro).

Before laying the tiles, we suggest you select from several cartons and arrange them as illustrated in the inspiration photo documentation in RAKO catalogues or website [www.cesarom.ro](http://www.cesarom.ro).

There are two recommended laying patterns to choose from: one is a strictly one-way oriented design, and the other resembles a chessboard look achieved through a regular 90° turn tiling pattern.



80x80

R9

A

V3

R

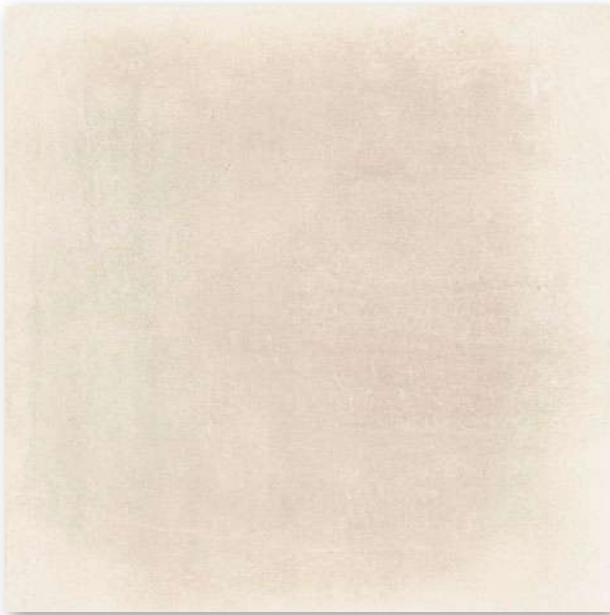

6485-0008 / DAK81743  
PEI 5  
mat | matt  
bej / beige

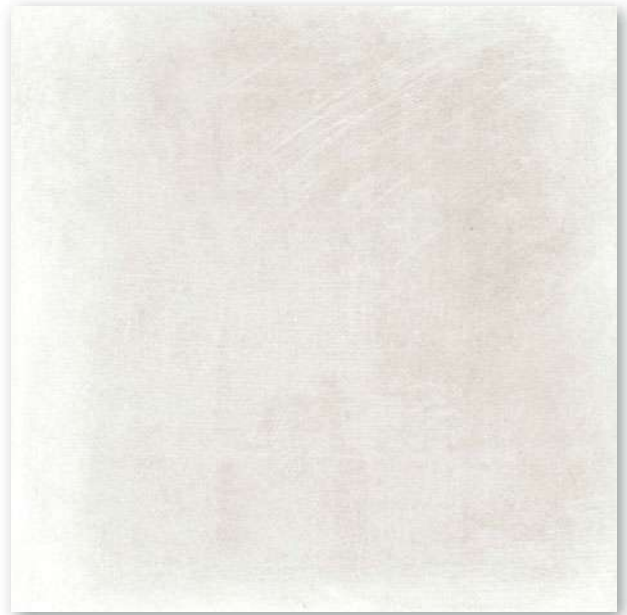

6485-0014 / DAK81740  
PEI 5  
mat | matt  
gri deschis / light gray

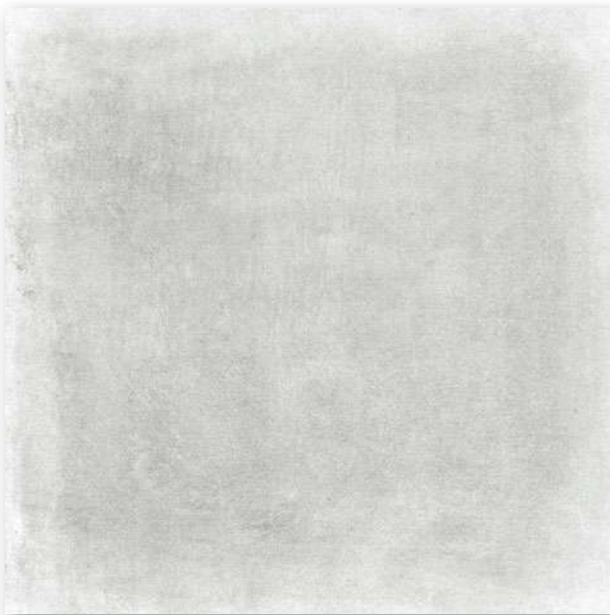

6485-0007 / DAK81741  
PEI 5  
mat | matt  
gri / gray

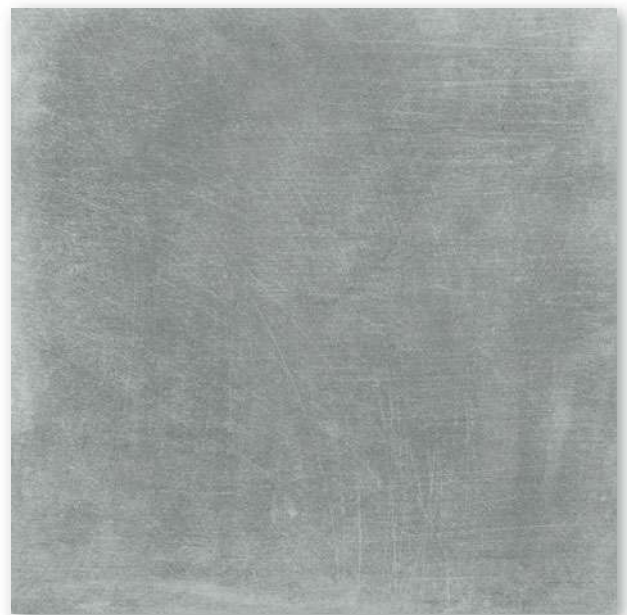

6485-0015 / DAK81742  
PEI 4  
mat | matt  
gri închis / dark gray

80x9.5

V3

R



6708-0009 / DSA89740 alb-gri / white-gray  
6708-0010 / DSA89741 gri / gray  
6708-0007 / DSA89742 gri închis / dark grey  
6708-0011 / DSA89743 bej / beige  
mat | matt

produs / product



EN



pcs/m<sup>2</sup>

m<sup>2</sup>



kg

kg/m<sup>2</sup>

brutto kg

gresie porțelanată / porcelain tile  
plintă / skirting plinth

80x80  
80x9,5

798x798x10  
798x95x10

EN 14411:2016, anex G Bla GL  
STO E. 030 - 059824

2  
10

1,6  
13,2

1,28  
0,76

42  
-

53,76  
-

28,0  
16,7

21,9  
21,9

1 202  
-

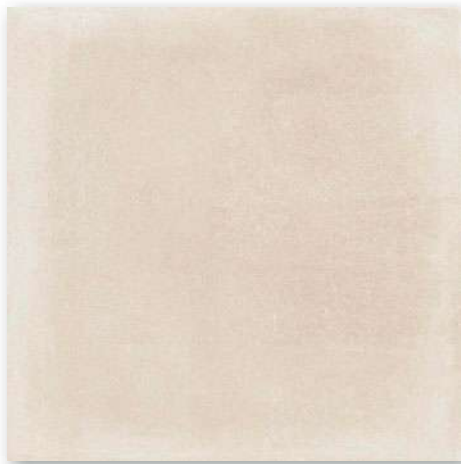
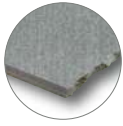

6441-0186 / DAK63743  
PEI 5  
mat | matt  
bej / beige

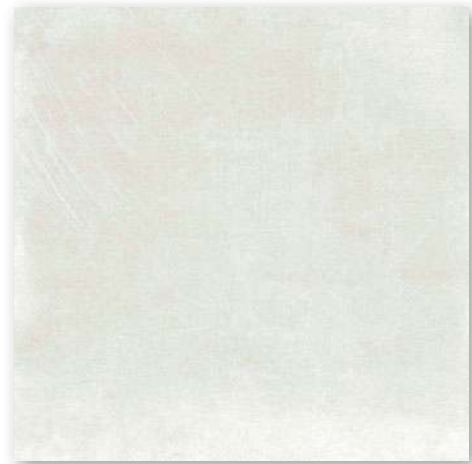

6441-0183 / DAK63740  
PEI 5  
mat | matt  
alb-gri / white-gray

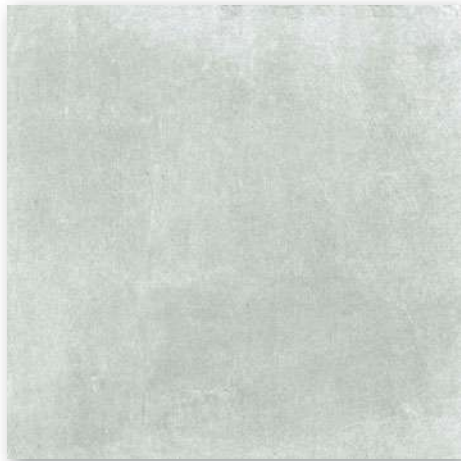

6441-0184 / DAK63741  
PEI 5  
mat | matt  
gri / gray

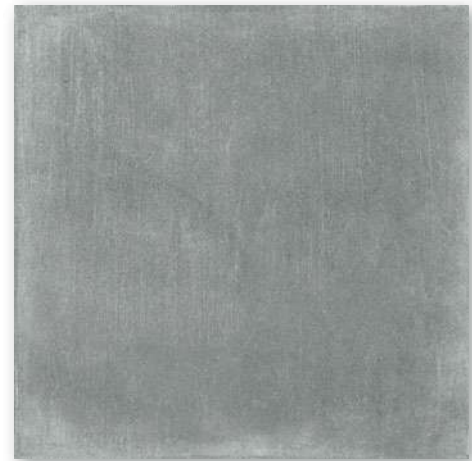

6441-0185 / DAK63742  
PEI 4  
mat | matt  
gri închis / dark gray

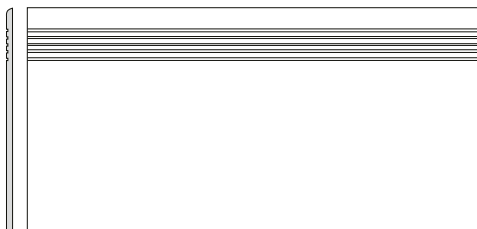

6860-0054 / DCPSE740 alb-gri / white-gray  
6860-0030 / DCPSE741 gri / gray  
6860-0029 / DCPSE742 gri închis / dark gray  
6860-0055 / DCPSE743 bej / beige  
PEI 4-5  
mat | matt



6706-0099 / DSAS4740 alb-gri / white-gray  
6706-0065 / DSAS4741 gri / gray  
6706-0058 / DSAS4742 gri închis / dark gray  
6706-0100 / DSAS4743 bej / beige  
mat | matt

30x60  
60x9,5



produs / product



produs / product	cm	mm	EN	pcs/m <sup>2</sup>	m <sup>2</sup>	m <sup>2</sup>	kg	kg/m <sup>2</sup>	brutto kg		
gresie porțelanată / porcelain tile	60x60	598x598x10	EN 14411:2016, annex G Bla GL	3	2,8	1,08	32	34,56	24,9	23,0	820
treaptă / step tile	30x60	298x598x10	STO č. 030 - 059824	6	5,6	1,08	40	-	23,7	21,9	971
plintă / skirting plinth	60x9,5	598x95x10	STO č. 030 - 059824	13	17,5	0,74	-	-	16,2	21,9	-

# cemento



produs / product



EN



gresie portelanată / porcelain tile  
mozaic set 5×5 cm / mosaic sheet 5×5 cm  
treaptă / step tile

60×60  
30×30  
30×60

598×598×10  
48×48×10  
298×598×10

EN 14411:2016, annex G Bla GL  
EN 14411:2016, annex G Bla GL  
STO č. 030 - 059824

3

2,8

1,08

32

34,56

24,9

23,0

820

3

11

0,27

-

5,8

21,5

-

6

5,6

1,08

40

-

23,7

21,9

971

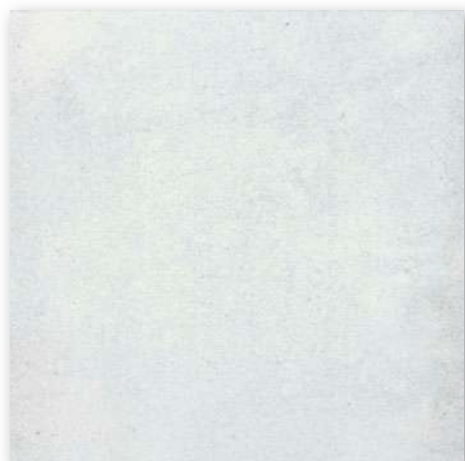

6461-0165 / DAK63660  
PEI 5  
mat | matt  
gri deschis / light gray



6461-0156 / DAK63661  
PEI 5  
mat | matt  
gri / gray

60x60

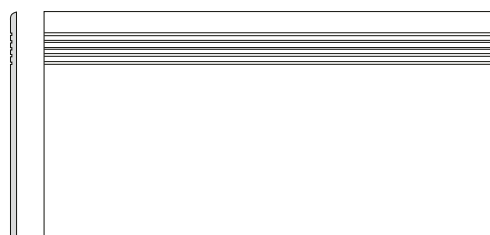

6860-0012 / DCPSE660 gri deschis / light gray  
6860-0019 / DCPSE661 gri / gray  
PEI 5  
mat | matt

30x60



6706-0064 / DSAS4660 gri deschis / light gray  
6706-0066 / DSAS4661 gri / gray  
mat | matt

60x9,5



6100-0110 / DDM06660 (SET)  
PEI 5 mat | matt  
gri deschis / light gray



6100-0052 / DDM06661 (SET)  
PEI 5 mat | matt  
gri / gray

30x30



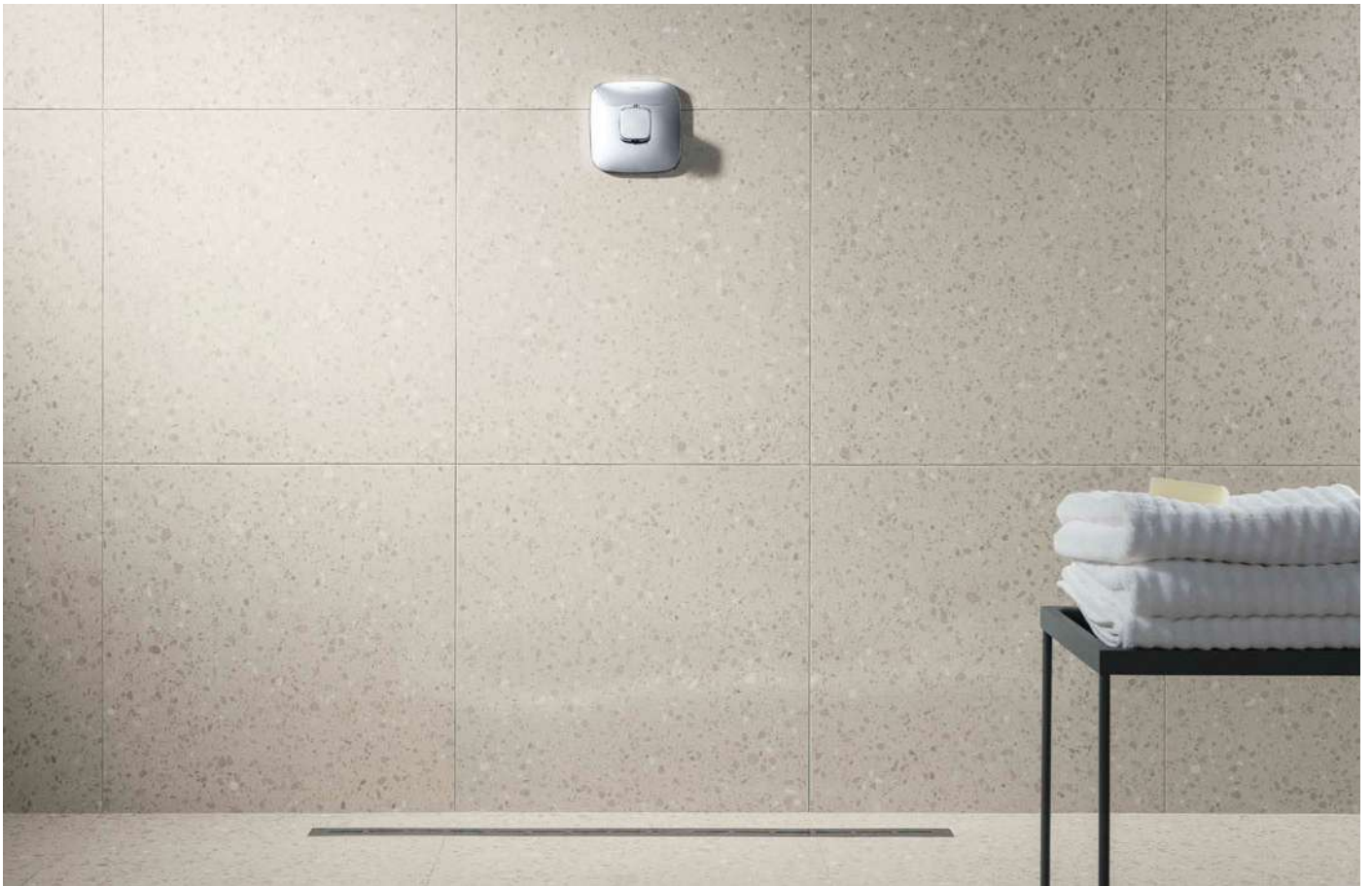



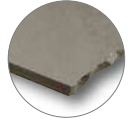

60x120

R10

B

V3

R



6493-0039 / DASV1810

PEI 5  
mat-lucios | matt-glossy  
alb / white

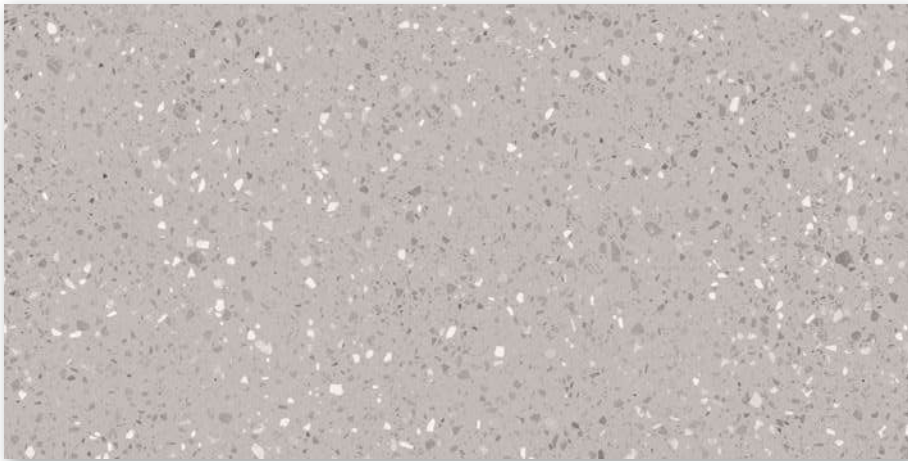

6493-0036 / DASV1811

PEI 4  
mat-lucios | matt-glossy  
gri / gray



6493-0037 / DASV1812

PEI 4  
mat-lucios | matt-glossy  
negru / black

produs / product



EN



pcs/m<sup>2</sup>



m<sup>2</sup>



kg/m<sup>2</sup>



gresie porțelanată / porcelain tile

60x120

598x1198x10

EN 14411-2016, annex G Bla GL

2

1,4

1,44

27

38,88

32,7

22,7

908





60x120  
 R10  
 B  
 V3  
 R

6493-0052 / DASV1813  
 PEI 5  
 mat-lucios | matt-glossy  
 bej / beige



6493-0047 / DASV1814  
 PEI 4  
 mat-lucios | matt-glossy  
 ocru / ochre

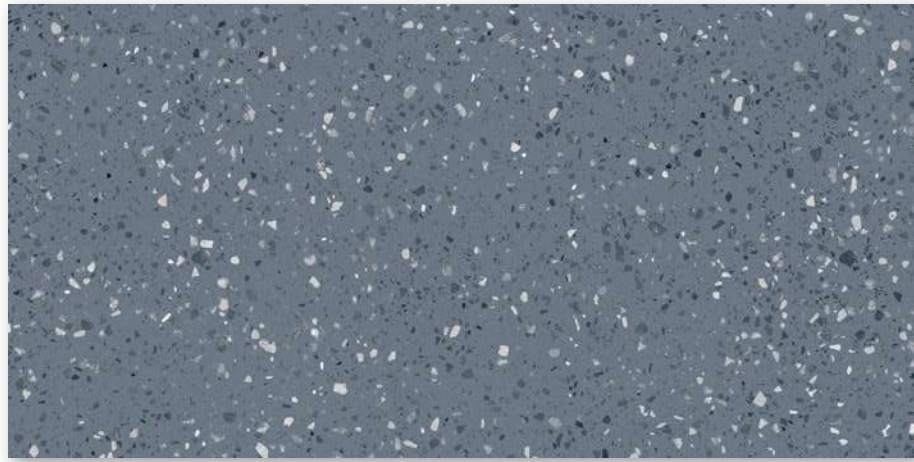

6493-0038 / DASV1815  
 PEI 4  
 mat-lucios | matt-glossy  
 albastru / blue

Înainte de a monta plăcile, vă sugerăm să selectați din mai multe cutii, să amestecați plăcile (inclusiv prin rotirea lor cu 180°) și să le aranjați așa cum este ilustrat în fotografia de inspirație sau să consultați site-ul [www.cesarom.ro](http://www.cesarom.ro).

Before laying the tiles, we suggest you select from several cartons and arrange them as illustrated in the inspiration photo documentation in RAKO catalogues or website [www.cesarom.ro](http://www.cesarom.ro). There are two recommended laying patterns to choose from: one is a strictly one-way oriented design, and the other resembles a chessboard look achieved through a regular 90° turn tiling pattern.



60x60

R10

B

V3

R



6461-0246 / DAS63810

PEI 5  
mat-lucios | matt-glossy  
alb / white



6461-0247 / DAS63813

PEI 5  
mat-lucios | matt-glossy  
bej / beige

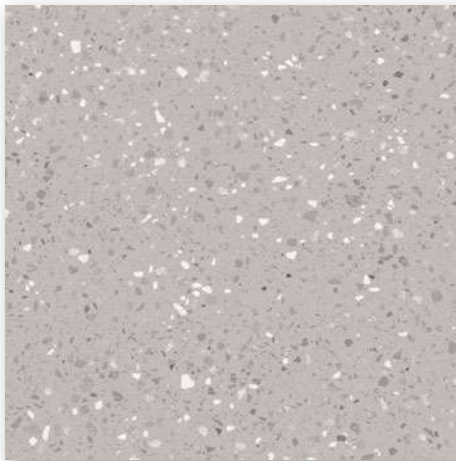

6461-0252 / DAS63811

PEI 4  
mat-lucios | matt-glossy  
gri / gray



6461-0248 / DAS63814

PEI 4  
mat-lucios | matt-glossy  
ocru / ochre

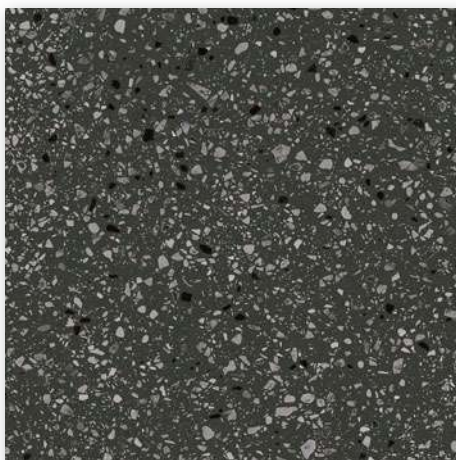

6461-0253 / DAS63812

PEI 4  
mat-lucios | matt-glossy  
negru / black

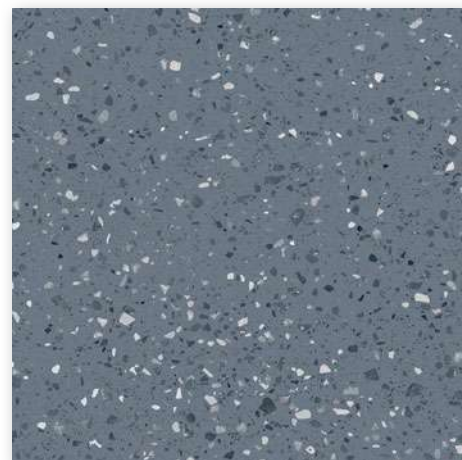

6461-0261 / DAS63815

PEI 4  
mat-lucios | matt-glossy  
albastru / blue



6432-0007 / DDM06810  
PEI 5  
mat-lucios | matt-glossy  
alb / white

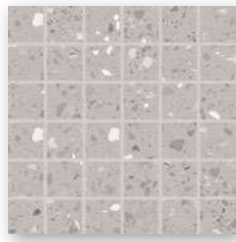

6432-0008 / DDM06811  
PEI 4  
mat-lucios | matt-glossy  
gri / gray

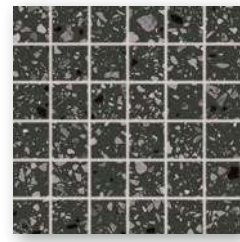

6432-0009 / DDM06812  
PEI 4  
mat-lucios | matt-glossy  
negru / black



6432-0006 / DDM06813  
PEI 5  
mat-lucios | matt-glossy  
bej / beige

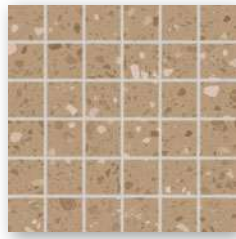

6432-0010 / DDM06814  
PEI 4  
mat-lucios | matt-glossy  
ocru / ochre

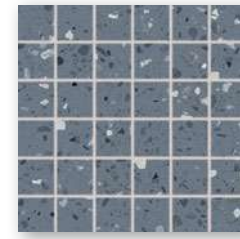

6432-0005 / DDM06815  
PEI 4  
mat-lucios | matt-glossy  
albastru / blue

30x30  
✂️  
R10  
B  
V3  
R

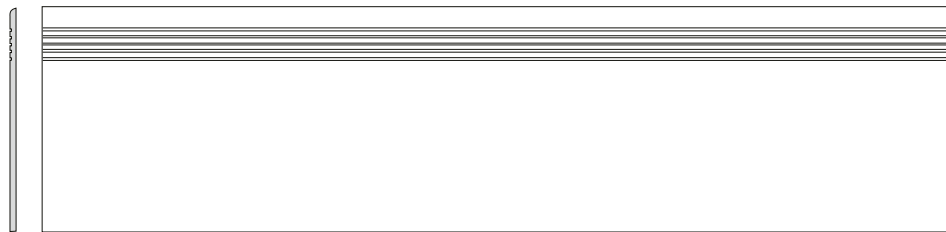

6895-0039 / DCPVF810 alb / white  
6895-0041 / DCPVF811 gri / grey  
6895-0042 / DCPVF812 negru / black  
6895-0040 / DCPVF813 bej / beige  
PEI 4-5  
mat-lucios | matt-glossy

30x120  
R10  
B  
V3  
R



6706-0102 / DSAS4810 alb / white  
6706-0103 / DSAS4811 gri / gray  
6706-0107 / DSAS4812 gri închis / dark grey  
6706-0108 / DSAS4813 bej / beige  
mat-lucios | matt-glossy

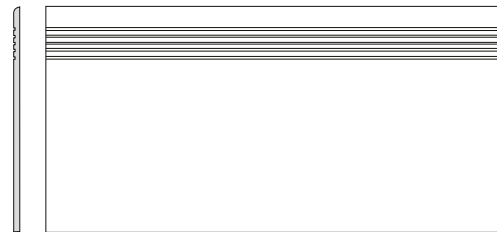

6860-0058 / DCPSE810 alb / white  
6860-0059 / DCPSE811 gri / gray  
6860-0060 / DCPSE812 gri închis / dark grey  
6860-0061 / DCPSE813 bej / beige  
PEI 4-5  
mat-lucios | matt-glossy

30x60  
60x9,5  
R10  
B  
V3  
R

produs / product



EN



pcs/m<sup>2</sup>



m<sup>2</sup>



kg



kg/m<sup>2</sup>



brutto kg

produs / product	cm	mm	EN	pcs/m <sup>2</sup>	m <sup>2</sup>	kg	kg/m <sup>2</sup>	brutto kg			
gresie portelanată / porcelain tile	60x60	598x598x10	EN 14411:2016, annex G Bla GL	3	2,8	1,08	32	34,56	24,9	23,0	820
mozaic set 5x5 cm / mosaic sheet 5x5 cm	5x5	48x48x10	EN 14411:2016, annex G Bla GL	3	11	0,27	-	-	5,8	21,5	-
treaptă / step tile	30x120	298x1198x10	STO ě. 030 - 059824	5	2,8	1,80	-	-	40,9	22,7	-
treaptă / step tile	30x60	298x598x10	STO ě. 030 - 059824	6	5,6	1,08	40	-	23,7	21,9	-
plintă / skirting plinth	60x9,5	598x95x10	STO ě. 030 - 059824	13	17,5	0,74	-	-	16,2	21,9	-

# piazzetta outdoor

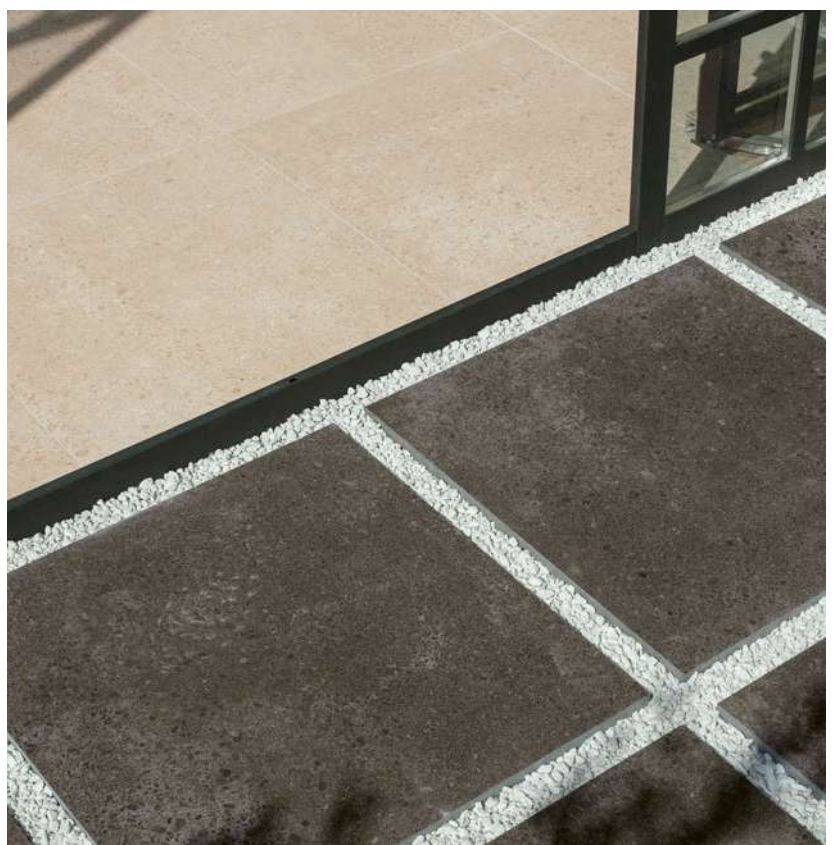

produs / product



gresie portelanată / porcelain tile  
treaptă / step tile

60×60  
60×60

598×598×20  
598×598×20

EN 14411 - G Bla  
STO č. 030 - 059824

2  
2

2,8  
-

0,72  
-

30  
-

21,60  
-

32,0  
32,0

44,4  
-

985  
-



5461-0039 / DAR66787  
mat | matt relief SR  
bej / beige



5461-0040 / DAR66788  
mat | matt relief SR  
gri / gray



5461-0035 / DAR66789  
mat | matt relief SR  
negru / black



60x60



UGL



60x60



6461-0262 / DAL63830

PEI 4

full lapatto

alb / white

60x9,5



6706-0091 / DSKS4830

full lapatto

alb / white

30x30



6132-0149 / DDL06830 (SET)

PEI 4

full lapatto

alb / white

produs / product



EN



gresie porțelanată / porcelain tile  
mozaic set 5x5 cm / mosaic sheet 5x5 cm  
plintă / skirting plinth

60x60

30x30

598x598x10

EN 14411:2016, annex G Bla GL

EN 14411:2016, annex G Bla GL

STO E. 030 - 059824

3

2,8

1,08

32

34,56

24,9

23,0

820

3

11

0,27

-

-

5,8

21,5

-

13

17,5

0,74

-

-

16,2

21,9

-



60x60  
 V4

6461-0266 / DAL63835  
 PEI 4  
 full lapatto  
 bej închis / dark beige



60x9,5

6706-0101 / DSKS4835  
 full lapatto  
 bej închis / dark beige



30x30  
 V4

6132-0150 / DDL06835 (SET)  
 PEI 4  
 full lapatto  
 bej închis / dark beige

produs / product



EN



gresie porțelanată / porcelain tile  
 mozaic set 5x5 cm / mosaic sheet 5x5 cm  
 plintă / skirting plinth

60x60 598x598x10  
 30x30 48x48x10  
 60x9,5 598x95x10

EN 14411:2016, annex G Bla GL  
 EN 14411:2016, annex G Bla GL  
 STO c. 030 - 059824

	pcs/m <sup>2</sup>	m <sup>2</sup>	kg/m <sup>2</sup>	kg	kg/m <sup>2</sup>	brutto kg		
gresie porțelanată / porcelain tile	3	2,8	1,08	32	34,56	24,9	23,0	820
mozaic set 5x5 cm / mosaic sheet 5x5 cm	3	11	0,27	-	-	5,8	21,5	-
plintă / skirting plinth	13	17,5	0,74	-	-	16,2	21,9	-









80x80

R9

A

V3



6485-0010 / DAK81735

PEI 5  
mat | matt

bej / beige



6485-0011 / DAK81736

PEI 4  
mat | matt

maro / brown

30x30



R10

B

V3



6132-0157 / DDM06735 (SET)

PEI 5 mat | matt  
bej / beige



6132-0156 / DDM06736 (SET)

PEI 4 mat | matt  
maro închis / dark brown

80x9.5

V3



6708-0012 / DSA89735 bej / beige  
6708-0013 / DSA89736 maro / brown  
6708-0014 / DSA89737 gri / gray  
6708-0015 / DSA89738 gri închis / dark gray  
6708-0008 / DSA89739 negru / black  
mat | matt

produs / product



EN



pcs/m<sup>2</sup>

m<sup>2</sup>



m<sup>2</sup>

kg

kg/m<sup>2</sup>

brutto kg

produs / product	cm	mm	EN	pcs/m <sup>2</sup>	m <sup>2</sup>	m <sup>2</sup>	kg	kg/m <sup>2</sup>	brutto kg		
gresie porțelanată / porcelain tile	80x80	798x798x10	EN 14411:2016, annex G Bla GL	2	1,6	1,28	42	53,76	28,0	21,9	1202
mozaic set 5x5 cm / mosaic sheet 5x5 cm	30x30	48x48x10	EN 14411:2016, annex G Bla GL	3	11	0,27	-	-	5,8	21,5	-
plintă / skirting plinth	80x9,5	798x95x10	STO E. 030 - 059824	10	13,2	0,76	-	-	16,7	21,9	-

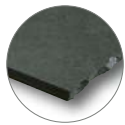

6485-0012 / DAK81737  
PEI 5  
mat | matt  
gri / gray



6485-0009 / DAK81738  
PEI 4  
mat | matt  
gri închis / dark gray



6132-0155 / DDM06737 (SET)  
PEI 5 mat | matt  
gri / gray



6132-0154 / DDM06738 (SET)  
PEI 4 mat | matt  
gri închis / dark gray



6485-0013 / DAK81739  
PEI 4  R9  A  
mat | matt  
negru / black



6132-0158 / DDM06739(SET)  
PEI 4 mat | matt  
negru / black



# quarzit outdoor



produs / product



60×60



598×598×20



EN 14411.2016, annex G B1a UGL



2



2,8



0,72



30



21,60



32,0



44,4



985

gresie portelanată / porcelain tile



60x60

R11

B

V3



6461-0191 / DAR66735  
mat | matt  
bej / beige

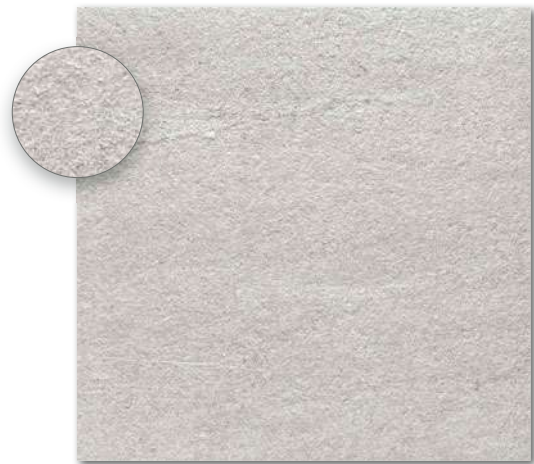

6461-0204 / DAR66737  
mat | matt  
gri / gray



6461-0203 / DAR66736  
mat | matt  
maro / brown



6461-0205 / DAR66738  
mat | matt  
gri inchis / dark gray



6461-0206 / DAR66739  
mat | matt  
negru / black



# random



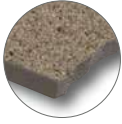

6061-0008 / DAK63676  
PEI 5  
mat | matt  
bej deschis / light beige



6061-0009 / DAK63677  
PEI 5  
mat | matt  
maro / brown



6061-0010 / DAK63678  
PEI 5  
mat | matt  
gri deschis / light gray



6061-0011 / DAK63679  
PEI 5  
mat | matt  
gri închis / dark gray



6100-0071 / DDM06679 (SET)  
PEI 5  
mat | matt |  
gri / gray



Înainte de a monta plăcile, vă sugerăm să selectați din mai multe cutii, să amestecați plăcile (inclusiv prin rotirea lor cu 180°) și să le aranjați așa cum este ilustrat în fotografia de inspirație sau să consultați site-ul [www.cesarom.ro](http://www.cesarom.ro).

Before laying the tiles, we suggest you select from several cartons and arrange them as illustrated in the inspiration photo documentation in RAKO catalogues or website [www.cesarom.ro](http://www.cesarom.ro).

There are two recommended laying patterns to choose from: one is a strictly one-way oriented design, and the other resembles a chessboard look achieved through a regular 90° turn tiling pattern.

produs / product											
gresie porțelanată / porcelain tile	60x60	598x598x10	EN 14411:2016, annex G Bla GL	3	2,8	1,08	32	34,56	24,9	23,0	820
mozaic set 5x5 cm / mosaic sheet 5x5 cm	30x30	48x48x10	EN 14411:2016, annex G Bla GL	3	11	0,27	-	-	5,8	21,5	-







1096-0011 / WARV5431  
mat | matt  
bej deschis / light beige



1260-0022 / WARV4431      1260-0151 / WARVK431  
mat | matt  
bej deschis / light beige

30x90  
30x60



1296-0002 / WR1V5431  
mat | matt  
bej deschis / light beige



1260-0112 / WR1VK431  
mat | matt  
bej deschis / light beige



1296-0003 / WR1V5434  
mat | matt  
maro / brown



1260-0024 / WR1V4434      1260-0138 / WARVK434  
mat | matt  
maro / brown

30x30

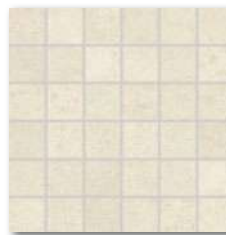
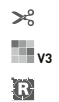

1600-0033 / WDM06431(SET)  
mat | matt  
bej deschis / light beige



1506-0169 / WLRSP431  
mat | matt

60x7



produs / product



produs / product	cm	mm	EN	Box	pcs/m <sup>2</sup>	m <sup>2</sup>	Box	m <sup>2</sup>	kg	kg/m <sup>2</sup>	Brutto kg
faianță / wall tile	30-90	298-898-10	EN 14411-2016, annex L BIII GL	4	3,7	1,08	30	32,40	20	18,5	625
faianță / wall tile	30-60	298-598-10	EN 14411-2016, annex L BIII GL	6	5,56	1,08	40	43,20	20,0	18,5	825
faianță / wall tile	30-60	298-598-0,8	EN 14411-2016, annex L BIII GL	8	5,56	1,44	40	57,60	21,3	14,8	876
brău relief / relief listel	60-7	598-70-10	EN 14411-2016, annex L BIII GL	4	23,8	0,17	-	-	3,4	20,1	-
mozaic set 5x5 cm / mosaic sheet 5x5 cm	30-30	48-48-10	EN 14411-2016, annex L BIII GL	3	11	0,27	-	-	5,0	18,5	-



produs / product



EN



gresie porțelanată / floor tile  
treaptă / step tile  
plintă / skirting plinth

60×60  
60×60  
60×9,5

598×598×10  
598×598×10  
598×95×10

EN 14411:2016, annex G Bla GL  
EN 14411:2016, annex G Bla GL  
STO ě. 030 - 059824

3  
6  
13

2,8  
5,6  
17,5

1,08  
1,08  
0,74

32  
40  
-

34,56  
--

23,7  
23,7  
16,2

21,9  
21,9  
21,9

782  
-  
-

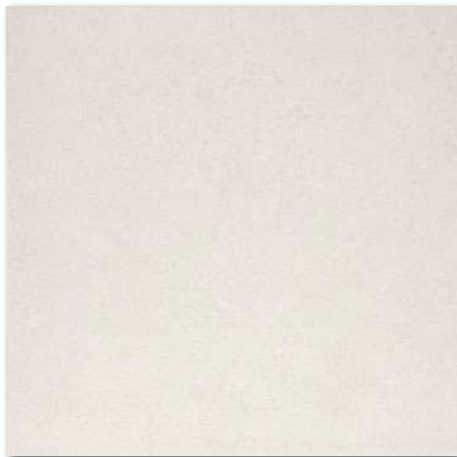

6461-0160 / DAK63430  
PEI 5  
mat | matt  
ivoriu / ivory

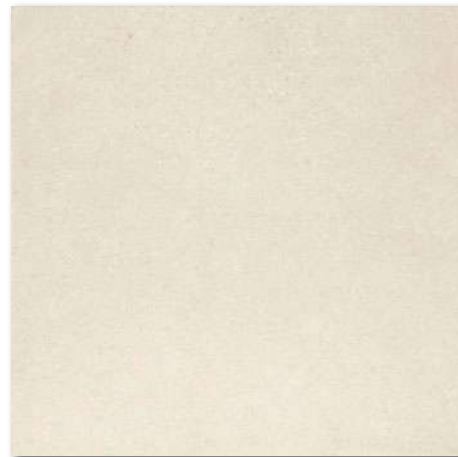

6461-0157 / DAK63431  
PEI 5  
mat | matt  
bej deschis / light beige



6461-0162 / DAK63432  
PEI 4  
mat | matt  
gri deschis / light gray



6461-0163 / DAK63433  
PEI 4  
mat | matt  
negru / black

60x60  
R9  
A  
V4  
E

30x60  
60x9,5  
R9  
A  
V4  
E

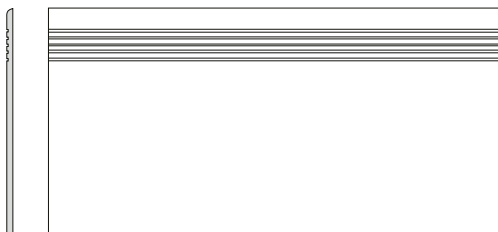

6860-0051 / DCPSE430 ivoriu / ivory  
6860-0063 / DCPSE431 bej deschis / light beige  
6860-0024 / DCPSE432 gri deschis / light grey  
6860-0052 / DCPSE433 negru / black  
PEI 4-5  
mat | matt



6706-0093 / DSAS4430 ivoriu / ivory  
6706-0122 / DSAS4431 bej deschis / light beige  
6706-0086 / DSAS4432 gri deschis / light grey  
6706-0094 / DSAS4433 negru / black  
mat | matt

Toate plăcile unui lot prezintă variații intenționate de nuanță. / All products of the entire batch show big deviations in shade difference.

Înainte de a monta plăcile, vă sugerăm să selectați din mai multe cutii, să amestecați plăcile (inclusiv prin rotirea lor cu 180°) și să le aranjați așa cum este ilustrat în fotografia de inspirație sau să consultați site-ul [www.cesarom.ro](http://www.cesarom.ro).

Before laying the tiles, we suggest you select from several cartons and arrange them as illustrated in the inspiration photo documentation in RAKO catalogues or website [www.cesarom.ro](http://www.cesarom.ro).

There are two recommended laying patterns to choose from: one is a strictly one-way oriented design, and the other resembles a chessboard look achieved through a regular 90° turn tiling pattern.





30x90



1096-0008 / WAKV5525  
mat | matt  
alb / white



1096-0009 / WAKV5526  
mat | matt  
gri deschis / light gray



30x90



1296-0005 / WR1V5000  
lucios | glossy  
alb / white

Home

**RAKO**

produs / product



30x90



298x898x10



EN 14411-2016, annex L BIII GL



4



3,7



1,08



30



32,40



20



18,5



625

faianță / wall tile





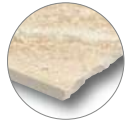

60x120

V3



6493-0013 / DARV1730

PEI 5

mat | matt    
ivoriu / ivory

6493-0031 / DAPV1730



PEI 5

mat | matt  



6493-0011 / DARV1732

PEI 5

mat | matt    
maro-gri / brown-gray

6493-0021 / DAPV1732

PEI 5

mat | matt  

30x120

R10

A

V3

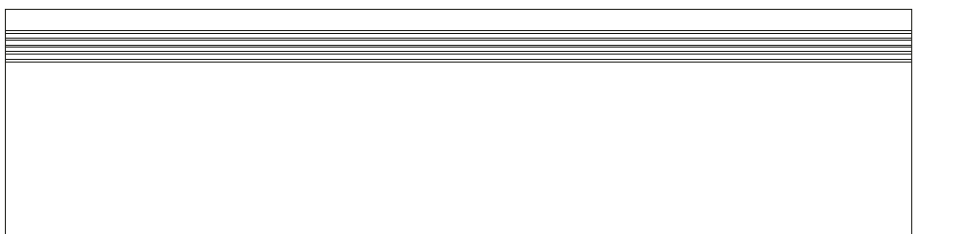

6895-0013 / DCPVF730

ivoriu / ivory

6895-0005 / DCPVF731

bej / beige

6895-0014 / DCPVF732

gri-maró / brown-gray

6895-0015 / DCPVF733

gri / grey

PEI 4-5

mat | matt

produs / product



EN



pcs/m<sup>2</sup>

m<sup>2</sup>



m<sup>2</sup>

kg

kg/m<sup>2</sup>

brutto kg

produs / product	cm	mm	EN	pcs/m <sup>2</sup>	m <sup>2</sup>	kg	kg/m <sup>2</sup>	brutto kg
gresie porțelanată / porcelain tile	60x120	598x1198x10	EN 14411-2016, annex G Bla GL	2	1,4	1,44	27	38,88
treaptă / step tile	30x120	298x1198x10	STO Ț. 030 - 059824	5	2,8	1,8	-	40,9
plintă / skirting plinth	60x9,5	598x95x10	STO Ț. 030 - 059824	13	17,5	0,74	-	16,2





60x120

V3



6493-0012 / DARV1731  
PEI 5  
mat | matt bej / beige

6493-0025 / DAPV1731  
PEI 5  
mat | matt lappato



6493-0020 / DARV1733  
PEI 4  
mat | matt gri / gray

6493-0022 / DAPV1733  
PEI 4  
mat | matt lappato



60x9,5

V3



- 6706-0114 / DSAS4730 ivoriu / ivory
- 6706-0115 / DSAS4731 bej / beige
- 6706-0116 / DSAS4732 maro-gri / brown-gray
- 6706-0117 / DSAS4733 gri / gray
- 6706-0118 / DSKS4730 ivoriu / ivory lappato
- 6706-0119 / DSKS4731 bej / beige lappato
- 6706-0120 / DSKS4732 maro-gri / brown-gray lappato
- 6706-0121 / DSKS4733 gri / gray lappato
- mat | matt

Toate plăcile unui lot prezintă variații intenționate de nuanță / All products of the entire batch show big deviations in shade difference.

Înainte de a monta plăcile, vă sugerăm să selectați din mai multe cutii, să amestecați plăcile (inclusiv prin rotirea lor cu 180°) și să le aranjați așa cum este ilustrat în fotografia de inspirație sau să consultați site-ul [www.cesarom.ro](http://www.cesarom.ro).

Before laying the tiles, we suggest you select from several cartons and arrange them as illustrated in the inspiration photo documentation in RAKO catalogues or website [www.cesarom.ro](http://www.cesarom.ro).

There are two recommended laying patterns to choose from: one is a strictly one-way oriented design, and the other resembles a chessboard look achieved through a regular 90° turn tiling pattern.



produs / product



EN



pcs/m<sup>2</sup>



m<sup>2</sup>



kg

kg/m<sup>2</sup>



brutto kg

gresie porțelanată / porcelain tile  
mozaic set 5x5 cm / mosaic sheet 5x5 cm

60x60  
30x30

598x598x10  
48x48x10

EN 14411:2016, annex G Bla GL  
EN 14411:2016, annex G Bla GL

3  
3

2,8  
11

1,08  
0,27

32  
-

34,56  
-

24,9  
5,8

23,0  
21,5

820  
-



30x30



6100-0047 / DDM06668 (SET)  
PEI 5  
mat | matt  
bej / beige



60x60

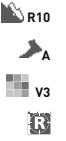

6061-0003 / DAK63668  
PEI 5  
mat | matt  
bej / beige



6100-0070 / DDM06666 (SET)  
PEI 5  
mat | matt  
gri deschis / light gray



6461-0150 / DAK63666  
PEI 5  
mat | matt  
gri deschis / light gray

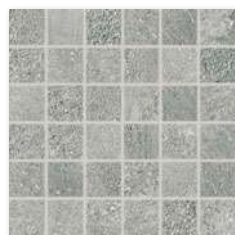

6100-0049 / DDM06667 (SET)  
PEI 5  
mat | matt  
gri / gray



6461-0158 / DAK63667  
PEI 5  
mat | matt  
gri / gray

# saloon

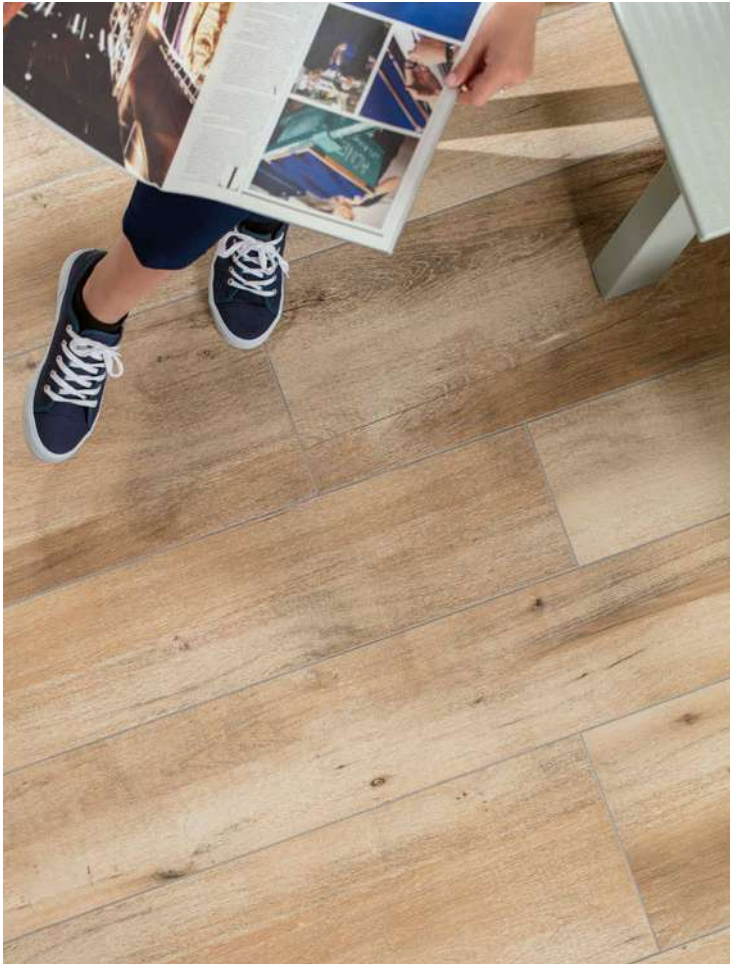





30x120



6495-0007 / DAKVF745  
PEI 5 mat | matt

20x120

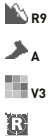

6494-0008 / DAKVG745  
PEI 5 mat | matt

20x80



6408-0102 / DAK82745  
PEI 5 mat | matt  
alb-gri / white-gray



6132-0130 / DDM06745 (SET)  
PEI 5 mat | matt

30x30



30x120



6495-0008 / DAKVF746  
PEI 4 mat | matt

20x120



6494-0005 / DAKVG746  
PEI 4 mat | matt

20x80



6408-0103 / DAK82746  
PEI 4 mat | matt  
bej / beige



6132-0131 / DDM06746 (SET)  
PEI 4 mat | matt

30x30



30x120

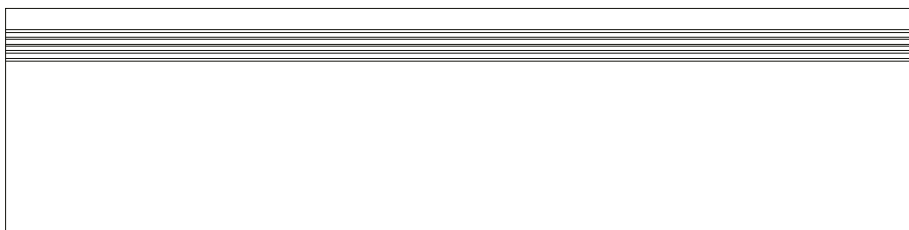

6895-0031 / DCPVF745 alb-gri / white-gray  
6895-0032 / DCPVF746 bej / beige  
6895-0033 / DCPVF747 maro deshis / light brown  
6895-0034 / DCPVF748 maro inchis / dark brown  
PEI 4-5 mat | matt





6495-0009 / DAKVF747  
PEI 4 mat | matt

30x120  
R9  
A  
V3  
R



6494-0006 / DAKVG747  
PEI 4 mat | matt

20x120  
R9  
A  
V3  
R

20x80

R9  
A  
V3  
R



6408-0104 / DAK82747  
PEI 4 mat | matt  
maro deschis / light brown



6132-0137 / DDM06747 (SET)  
PEI 4 mat | matt

30x30  
R10  
A  
V3  
R



6495-0010 / DAKVF748  
PEI 4 mat | matt

30x120  
R9  
A  
V3  
R



6494-0007 / DAKVG748  
PEI 4 mat | matt

20x120  
R9  
A  
V3  
R

20x80

R9  
A  
V3  
R



6408-0105 / DAK82748  
PEI 4 mat | matt  
maro închis / dark brown



6132-0135 / DDM06748 (SET)  
PEI 4 mat | matt

30x30  
R10  
A  
V3  
R

60x7,2  
R



6706-0111 / DSASP745 alb-gri / white-gray  
6706-0112 / DSASP746 bej / beige  
6706-0113 / DSASP747 maro deschis / light brown  
6706-0059 / DSASP748 maro închis / dark brown  
mat | matt

produs / product



produs / product	cm	mm	EN	pcs/m <sup>2</sup>	m <sup>2</sup>	kg	kg/m <sup>2</sup>	brutto kg
gresie porțelanată / porcelain tile	30x120	298x1198x10	EN 14411:2016, annex G Bla GL	5	2,8	1,08	40	43,2
gresie porțelanată / porcelain tile	20x120	198x1198x10	EN 14411:2016, annex G Bla GL	4	2,2	0,96	32	30,72
gresie porțelanată / porcelain tile	20x80	198x78x10	EN 14411:2016, annex G Bla GL	4	6,25	0,64	72	46,08
mosaic set 5x5 cm / mosaic sheet 5x5 cm	30x30	48x48x10	EN 14411:2016, annex G Bla GL	3	11	0,27	-	5,8
treaptă / step tile	30x120	298x1198x10	STO č. 030 - 059824	5	2,8	1,80	-	40,9
plintă / skirting plinth	60x7,2	598x72x10	STO č. 030 - 059824	13	23,2	0,56	-	12,3

**board**





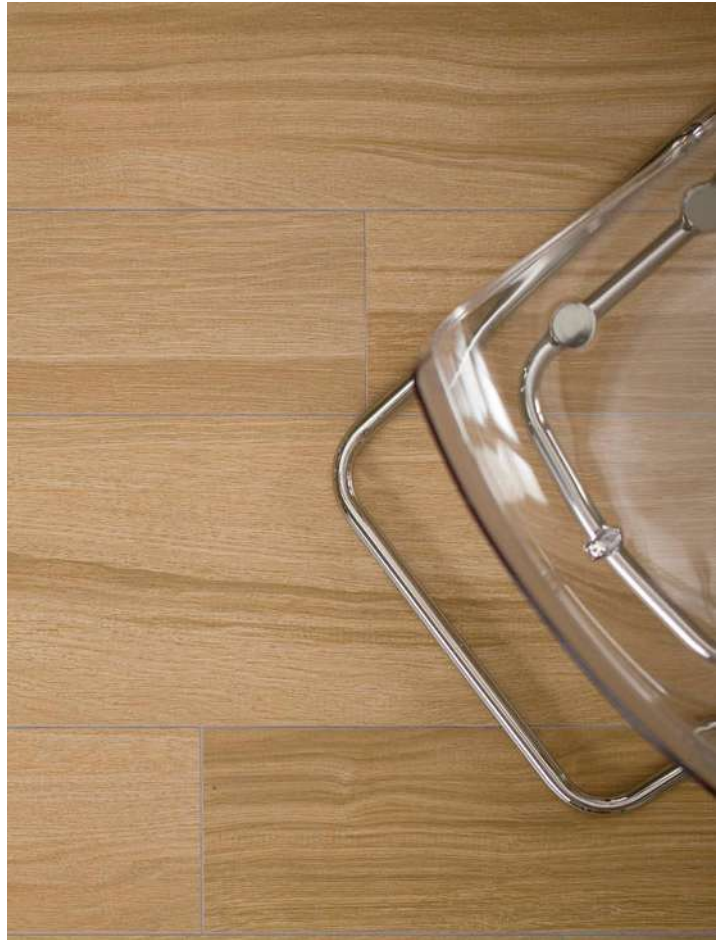



30x120		6495-0011 / DAKVF141 PEI 5 mat   matt
30x30		6100-0111 / DDM06141 (SET) PEI 5 mat   matt bej deschis / light beige
20x120		6494-0009 / DAKVG141 PEI 5 mat   matt bej deschis / light beige
30x120		6495-0013 / DAKVF142 PEI 4 mat   matt
30x30		6100-0112 / DDM06142 (SET) PEI 4 mat   matt bej / beige
20x120		6494-0001 / DAKVG142 PEI 4 mat   matt bej / beige
30x120		6495-0014 / DAKVF143 PEI 4 mat   matt
30x30		6100-0113 / DDM06143 (SET) PEI 4 mat   matt maro / brown
20x120		6494-0002 / DAKVG143 PEI 4 mat   matt maro / brown

produs / product			EN		pcs/m <sup>2</sup>	m <sup>2</sup>		m <sup>2</sup>	kg	kg/m <sup>2</sup>	brutto kg
gresie portelanată / porcelain tile	30x120	298x1198x10	EN 14411:2016, anex G Bla GL	5	2,8	1,08	40	43,2	24,5	22,7	1006
gresie portelanată / porcelain tile	20x120	198x1198x10	EN 14411:2016, anex G Bla GL	4	4,2	0,96	32	30,72	21,8	22,7	723
decor / deco	20x120	198x1198x10	EN 14411:2016, anex G Bla GL	4	4,2	0,96	-	-	21,8	22,7	-
mozaic set 5x5 cm / mosaic sheet 5x5 cm	30x30	48x48x10	EN 14411:2016, anex G Bla GL	3	11	0,27	-	-	5,8	21,5	-
treaptă / step tile	30x120	298x1198x10	STO é. 030 - 059824	5	2,8	1,80	-	-	40,9	22,7	-
plintă / skirting plinth	60x9,5	598x95x10	STO é. 030 - 059824	13	17,5	0,74	-	-	16,2	21,9	-



120x30



6495-0012 / DAKVF144  
PEI 4 mat | matt



6100-0075 / DDM06144 (SET)  
PEI 4  
mat | matt  
maro închis / dark brown

30x30



120x20



6494-0003 / DAKVG144  
PEI 4 mat | matt  
maro închis / dark brown

120x30



6495-0006 / DAKVF140  
PEI 5 mat | matt



6100-0074 / DDM06140 (SET)  
PEI 5  
mat | matt  
gri deschis / light gray

30x30



6494-0004 / DAKVG140  
PEI 5 mat | matt  
gri deschis / light gray

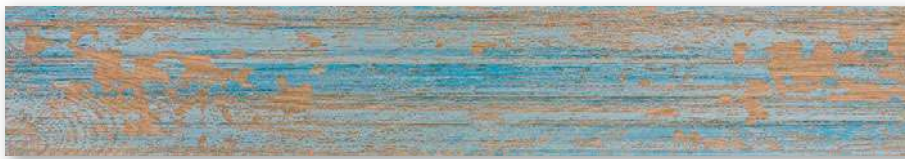

6694-0002 / DDTVG467  
PEI 4  
mat | matt  
bej-turcoaz / beige-turquoise

120x20

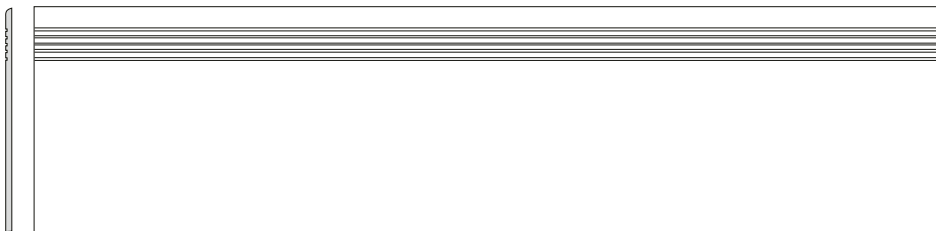

6895-0036 / DCPVF140 gri deschis / light gray  
6895-0035 / DCPVF141 bej deschis / light beige  
6895-0001 / DCPVF142 bej / beige

6895-0037 / DCPVF143 maro / brown  
6895-0038 / DCPVF144 maro închis / dark brown  
PEI 4-5 mat | matt

30x120



6706-0092 / DSAS414 bej deschis / light beige  
6706-0062 / DSAS4142 bej / beige  
6706-0105 / DSAS4143 maro / brown  
6706-0106 / DSAS4144 maro închis / dark brown  
6706-0104 / DSAS4140 gri deschis / light gray

60x9,5



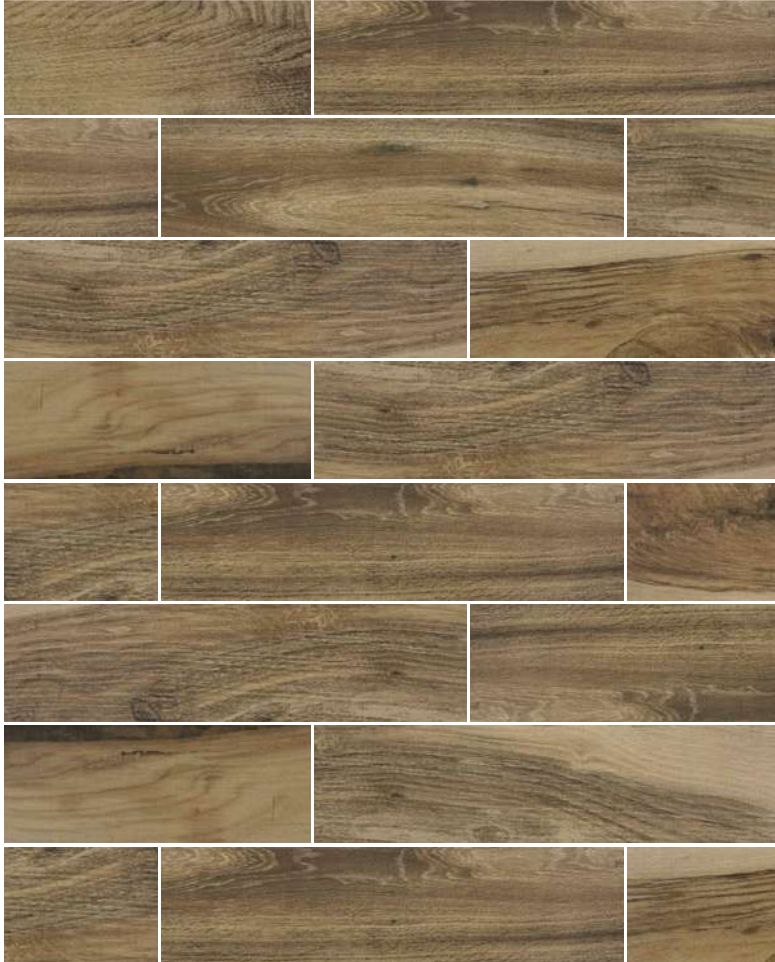



15x60



6463-0008 / DARSU719  
PEI 5  
mat | matt  
gri deschis / light grey



6100-0069 / DDM06719 (SET)  
PEI 5  
mat | matt  
gri deschis / light grey

30x30



6463-0006 / DARSU715  
PEI 5  
mat | matt  
bej-gri / beige-gray



6100-0060 / DDM06715 (SET)  
PEI 5  
mat | matt  
bej-gri / beige-gray



6463-0004 / DARSU716  
PEI 4  
mat | matt  
bej / beige



6100-0061 / DDM06716 (SET)  
PEI 4  
mat | matt  
bej / beige



6463-0007 / DARSU717  
PEI 4  
mat | matt  
maro deschis / light brown

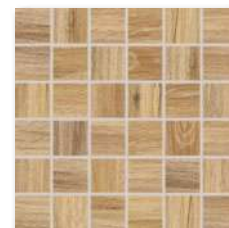

6100-0062 / DDM06717 (SET)  
PEI 4  
mat | matt  
maro deschis / light brown



6463-0005 / DARSU718  
PEI 4  
mat | matt  
maro / brown



6100-0063 / DDM06718 (SET)  
PEI 4  
mat | matt  
maro / brown

produs / product



gresie portelanată / porcelain tile  
mozaic set 5x5 cm / mosaic sheet 5x5 cm

15x60  
30x30

148x598x10  
48x48x10

EN 14411:2016, annex G Bla GL  
EN 14411:2016, annex G Bla GL

10  
3

11,1  
11

0,90  
0,27

48  
-

43,2  
-

19,4  
5,8

21,5  
21,5

954  
-



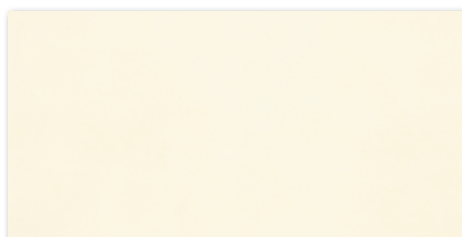

1260-0001 / WAKV4510  
lucios | glossy  
ivoriu / ivory

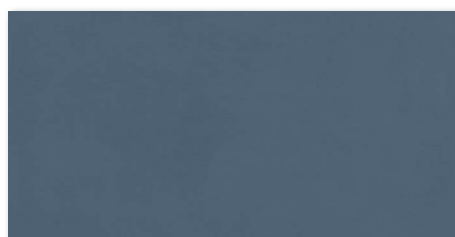

1260-0002 / WAKV4511  
lucios | glossy  
albastru închis / dark blue

30x60

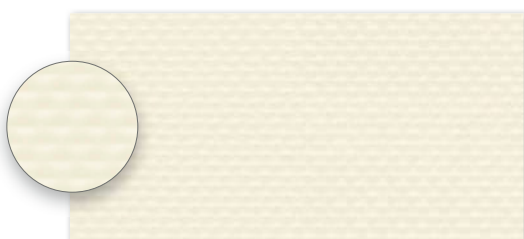

1260-0003 / WR3V4510\*  
lucios | glossy  
ivoriu / ivory



1260-0004 / WR3V4511\*  
lucios | glossy  
albastru închis / dark blue



1506-0171 / WLASN511  
lucios | glossy

60x2,3

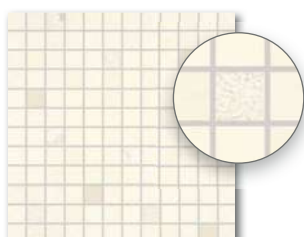

1600-0043 / WDM02510(SET)  
lucios | glossy  
ivoriu / ivory

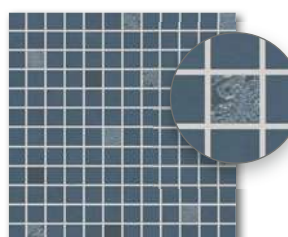

1600-0044 / WDM02511(SET)  
lucios | glossy  
albastru închis / dark blue

30x30



Home

RAKO

produs / product



EN



pcs/m<sup>2</sup>

m<sup>2</sup>



m<sup>2</sup>



kg/m<sup>2</sup>

brutto kg

produs / product	cm	mm	EN	box	pcs/m <sup>2</sup>	m <sup>2</sup>	box	m <sup>2</sup>	kg	kg/m <sup>2</sup>	brutto kg
faianță / wall tile	30x60	298x598x10	EN 14411:2016, annex L BIII GL	6	5,56	1,08	40	43,20	20,0	18,5	825
brâu / listel	60x2,3	598x23x10	EN 14411:2016, annex L BIII GL	6	72,5	0,08	-	-	1,5	18,5	-
mozaic set 2,5x2,5 cm / mosaic sheet 2,5x2,5 cm	30x30	23x23x10	EN 14411:2016, annex L BIII GL	3	11	0,27	-	-	5,0	18,5	-

\* Pentru un efect optim este recomandat să montați plăcile într-o singură direcție. / For optimal effect, the laying of individual tiles in one direction is recommended.





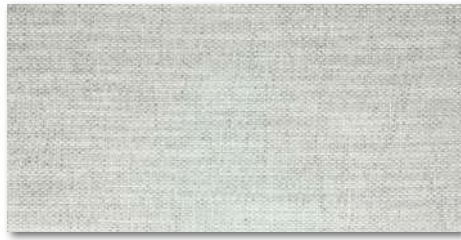

1260-0005 / WARV4501  
mat | matt  
gri / gray

1260-0170 / WARVK500  
**8mm**

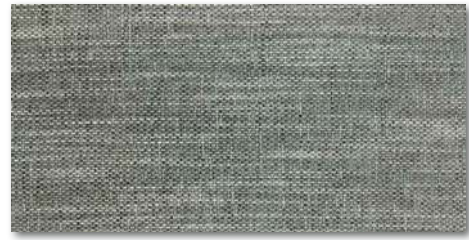

1260-0006 / WARV502  
mat | matt  
gri închis / dark grey

1260-0171 / WARVK501  
**8mm**

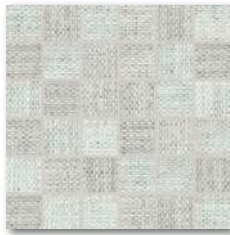

1600-0039 / DDM06501 (SET)  
mat | matt  
gri / gray

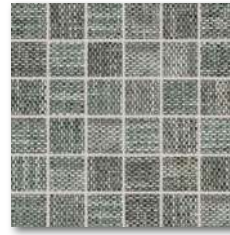

1600-0040 / DDM06502 (SET)  
mat | matt  
gri închis / dark grey

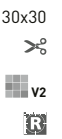

1506-0163 / WLAVD502  
mat | matt

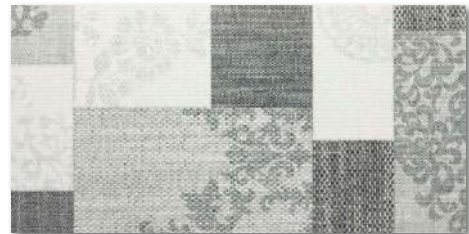

1260-0007 / WARV4503\*  
mat | matt  
multicolor / multicoloured



produs / product



produs / product	cm	mm	EN	Tray	pcs/m <sup>2</sup>	m <sup>2</sup>	Tray	m <sup>2</sup>	kg	kg/m <sup>2</sup>	brutto kg
faianță / wall tile	30x60	298x598x10	EN 14411:2016, annex L BIII GL	6	5,56	1,08	40	43,20	20,0	18,5	825
faianță / wall tile	30x60	298x598x0,8	EN 14411:2016, annex L BIII GL	8	5,56	1,44	40	57,60	21,3	14,8	876
brâu / listel	60x5	598x48x10	EN 14411:2016, annex L BIII GL	11	33,3	0,33	-	-	6,1	18,5	-
mozaic set 5x5 cm / mosaic sheet 5x5 cm	30x30	48x48x10	EN 14411:2016, annex L BIII GL	3	11	0,27	-	-	5,0	18,5	-

\*Plăcile sunt intenționat amestecate în cutii pentru a obține un design aleator, natural. | The products are deliberately mixed in packing to include a random selection of designs.



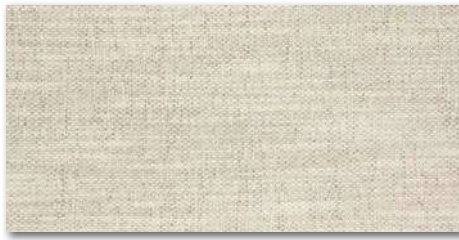

1260-0008 / WARV4505  
mat | matt  
bej / beige

1260-0180 / WARVK504  
8mm



1260-0009 / WARV4506  
mat | matt  
maro / brown

30x60



1600-0041 / DDM06505 (SET)  
mat | matt  
bej / beige



1600-0042 / DDM06506 (SET)  
mat | matt  
maro / brown

30x30



1506-0165 / WLAVD506  
mat | matt

60x5

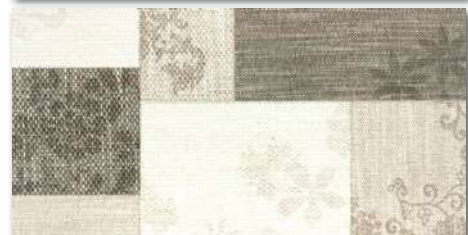

1260-0010 / WARV4507\*  
mat | matt |  
multicolor / multicoloured

30x60



produs / product



produs / product	cm	mm	EN	pcs/m <sup>2</sup>	m <sup>2</sup>	kg	kg/m <sup>2</sup>	brutto kg			
faianță / wall tile	30x60	298x598x10	EN 14411:2016, annex L BIII GL	6	5,56	1,08	40	43,20	20,0	18,5	825
faianță / wall tile	30x60	298x598x0,8	EN 14411:2016, annex L BIII GL	8	5,56	1,44	40	57,60	21,3	14,8	876
brâu / listel	60x5	598x48x10	EN 14411:2016, annex L BIII GL	11	33,3	0,33	-	-	6,1	18,5	-
mozaic set 5x5 cm / mosaic sheet 5x5 cm	30x30	48x48x10	EN 14411:2016, annex L BIII GL	3	11	0,27	-	-	5,0	18,5	-

\*Plăcile sunt intenționat amestecate în cutii pentru a obține un design aleator, natural. | The products are deliberately mixed in packing to include a random selection of designs.



**RAKO**

Brand of lasselsbergergroup

**object**

2024



A unique collection of twelve brand new colors in wide range of formats in both wall and floor tiles. Neutral and uniform soft granite design offers never-ending possibilities within Compila series, or by combining with other RAKO series, to transform any public or residential space.

It can be as original as you are!

„The ultimate compilation of colors,  
formats and decorations.“





O colecție unică de douăsprezece culori noi, într-o gamă largă de formate de faianță și gresie. Designul uniform de granit fin oferă posibilități nelimitate în colecția Compila și prin combinarea cu alte colecții, pentru amenajarea oricărui spațiu public sau rezidențial. Poate fi la fel de original ca tine!

„Compilația completă a culorilor,  
formatelor și decorațiilor.”



10x30  
30x60

mint

botanic

aqua

nude



taupe



cement



paper



shadow



storm

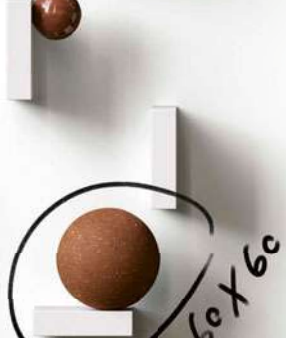

cotto



burn



sand

# COMPILATION 001

Floor  
• COMPILA COTTO  
60x60  
• PLYWOOD HONEY  
60x120

WALL

• COMPILA PAPER  
30x60  
• COMPILA MINT  
30x60  
• COMPILA MINT  
10x30





# the art of compilations

Compilații care te inspiră

Colecția Compila este concepută pentru a satisface atât cerințele estetice, cât și cele tehnice.

Paginile următoare prezintă compoziții individuale ale produselor, ilustrând combinațiile posibile ale diferitelor elemente din colecția Compila, precum și alte produse din gama RAKO.

Definită prin versatilitatea, originalitatea și creativitatea sa, colecția prezintă o gamă diversă de culori, formate și suprafețe. De la luciu intens la mat complet, fiecare produs este prezentat cu un tip specific de suprafață, clarificat prin modele sferice pentru o vizualizare mai bună.

Imaginile orientate vertical afișează elemente concepute pentru pereți, în timp ce imaginile poziționate orizontal reprezintă produsele de gresie pentru pardoseală. Aceste vizualizări oferă o înțelegere clară a aspectului final care poate fi obținut odată ce produsele selectate sunt instalate într-un spațiu.

Cu toate că am pregătit nouă compilări diferite, evidențiind produsele RAKO, colecția Compila deschide ușile spre o varietate infinită de posibilități, permițându-vă să vă exprimați creativitatea și să proiectați un spațiu care să reflecte stilul dumneavoastră unic. Alegerea este în mâinile dumneavoastră...

Compilation for Your Inspiration...

The Compila series is designed to meet both aesthetics and technical requirements.

The following pages showcase individual product compositions, illustrating the possible combinations of different elements from the Compila series as well as other products within the RAKO range.

Defined by its versatility, originality and creativity, the series presents a diverse range of colors, formats, and surfaces. From high gloss to full matt, each product is presented with a specific surface type, clarified through sphere models for better visualization.

The vertically oriented shelf displays elements designed for walls, while the horizontally positioned partitions represent floor tile products. These visualizations provide a clear understanding of the final look that can be achieved once the selected products are installed in a space.

While we have prepared nine different compilations featuring RAKO products, the Compila series opens the door to limitless possibilities, allowing you to release your creativity and design a space that reflects your unique style. It's up to you.....



# compilation 001

10×30  
compila  
mini

30×60  
compila  
mini

30×60  
compila  
paper

60×60  
compila  
cotto

60×120  
plywood  
honey



# compilation 002



# compilation 003

10x30  
compila  
storm, aqua,  
paper, cement

30x60  
onyx  
dark beige

20x40  
color one  
dark yellow

40x120  
onyx  
light beige

60x60  
compila  
cement

60x120  
bricola  
ale

60x60  
compila  
storm

60x60  
compila  
paper



# compilation 004



# compilation 005



# compilation 006

10x30  
compila  
cotto



30x60  
compila  
galne



20x120  
bricola  
barrique



30x60  
compila  
paper



30x60  
compila  
taupe

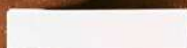

60x120  
compila  
cotto

60x120  
vals  
natural



# compilation 007

10x30  
compila  
botanic



30x60  
compila  
cement



20x40  
color one  
light blue



40x120  
cava  
white



30x60  
compila  
botanic



60x60  
vals  
natural

60x120  
bricola  
cognac





# compilation 008



# compilation 009

10x30  
compila  
botanic



30x60  
compila  
herbs



30x60  
compila  
paper



60x120  
plywood  
doppio



80x80  
castone  
ash











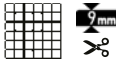
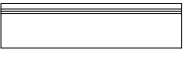

# next compilations ...

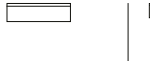
... IT'S UP TO YOU.





produs / product		 9mm	 9mm				
EN 14411 - 6 Bla	gresie / floor tile	gresie / floor tile	gresie / floor tile	gresie / floor tile	gresie / floor tile		
	60×120 	60×60 	30×60 	45×45	30×30		
	598×1198×10	598×598×9	298×598×9	448×448×8	298×298×8		
suprafață / surface	ABS	ABS	mat   matt	ABS	mat   matt	ABS	ABS
rezistență la alunecare slip resistance	R10/B	R10/B	R11/B	R10/B	R11/B	R10/B	R10/B
coeficient de frecare la alunecare sliding friction coefficient	$\mu \geq 0,6$	$\mu \geq 0,6$	$\mu \geq 0,6$	$\mu \geq 0,6$	$\mu \geq 0,6$	$\mu \geq 0,6$	$\mu \geq 0,6$
culoare / color							
<b>Shadow</b> gri închis dark grey	DAKV1866 ○ 87   m <sup>2</sup>	DAK62866 ○ 82   m <sup>2</sup>	DAF62866 ○ 84   m <sup>2</sup>	DAKSR866 ○ 82   m <sup>2</sup>	DAFSR866 ○ 84   m <sup>2</sup>	DAA4H866 ○ 76   m <sup>2</sup>	DAA34866 ○ 72   m <sup>2</sup>
<b>Taupe</b> grij grey-beige	DAKV1867 ○ 87   m <sup>2</sup>	DAK62867 ○ 82   m <sup>2</sup>	DAF62867 ○ 84   m <sup>2</sup>	DAKSR867 ○ 82   m <sup>2</sup>	DAFSR867 ○ 84   m <sup>2</sup>	DAA4H867 ○ 76   m <sup>2</sup>	DAA34867 ○ 72   m <sup>2</sup>
<b>Paper</b> alb-gri white-grey	DAKV1864 ○ 87   m <sup>2</sup>	DAK62864 ○ 82   m <sup>2</sup>		DAKSR864 ○ 82   m <sup>2</sup>		DAA4H864 ○ 76   m <sup>2</sup>	DAA34864 ○ 72   m <sup>2</sup>
<b>Cement</b> gri   grey	DAKV1865 ○ 87   m <sup>2</sup>	DAK62865 ○ 82   m <sup>2</sup>	DAF62865 ○ 84   m <sup>2</sup>	DAKSR865 ○ 82   m <sup>2</sup>	DAFSR865 ○ 84   m <sup>2</sup>	DAA4H865 ○ 76   m <sup>2</sup>	DAA34865 ○ 72   m <sup>2</sup>
<b>Storm</b> albastru închis dark blue	DAKV1870 ○ 87   m <sup>2</sup>	DAK62870 ○ 82   m <sup>2</sup>		DAKSR870 ○ 82   m <sup>2</sup>		DAA4H870 ○ 76   m <sup>2</sup>	DAA34870 ○ 72   m <sup>2</sup>
<b>Cotto</b> maro roșcat brown-red	DAKV1869 ○ 87   m <sup>2</sup>	DAK62869 ○ 82   m <sup>2</sup>		DAKSR869 ○ 82   m <sup>2</sup>		DAA4H869 ○ 76   m <sup>2</sup>	DAA34869 ○ 72   m <sup>2</sup>
<b>Sand</b> ocru   ochre	DAKV1868 ○ 87   m <sup>2</sup>	DAK62868 ○ 82   m <sup>2</sup>		DAKSR868 ○ 82   m <sup>2</sup>		DAA4H868 ○ 76   m <sup>2</sup>	DAA34868 ○ 72   m <sup>2</sup>
<b>Coal</b> maro-negru brown-black	DAKV1871 ○ 87   m <sup>2</sup>	DAK62871 ○ 82   m <sup>2</sup>		DAKSR871 ○ 82   m <sup>2</sup>		DAA4H871 ○ 76   m <sup>2</sup>	DAA34871 ○ 72   m <sup>2</sup>
informații logistice / logistic information							
	2	4		7		6	13
 ks/m <sup>2</sup>	1,4	2,8		5,6		5	11
 m <sup>2</sup>	1,44	1,44		1,26		1,21	1,18
	27	32		40		34	48
 m <sup>2</sup>	38,88	46,08		50,40		41,14	56,64
 kg	32,7	27,6		24,2		21,1	20,5
 kg/m <sup>2</sup>	22,7	19,2		19,2		17,4	17,4
 brutto kg	908	910		993		741	1 011

 gresie / floor tile	 mozaic gresie 30×30 cm mosaic sheet 30×30cm	 treaptă / step tile	 treaptă / step tile	 piesă specială treaptă / special step tile	 plintă / skirting plinth	 plintă / skirting plinth	 plintă / skirting plinth
<b>10×10</b> 	<b>5×5</b> 	<b>30×120</b> 	<b>30×60</b> 	<b>30×120</b> 	<b>60×7,2</b> 	<b>45×8,5</b>	<b>30×7,2</b>
98×98×9	48×48×9	298×1198×10	298×598×9	298×1198×10	598×72×9	448×85×8	298×72×8
ABS	ABS	ABS	ABS	ABS	ABS	ABS	ABS
R10/B	R10/B	R10/B	R10/B	R10/B			
$\mu \geq 0,6$	$\mu \geq 0,6$	$\mu \geq 0,6$	$\mu \geq 0,6$	$\mu \geq 0,6$			
<b>DAK11866</b> ○ 94   m <sup>2</sup>	<b>DDM05866</b> ○ 72   set	<b>DCPVF866</b> ○ 86   ks	<b>DCPSR866</b> ○ 72   ks	<b>DCFVF866</b> ○ 114   ks	<b>DSAS3866</b> ○ 56   ks	<b>DSAPS866</b> ○ 54   ks	<b>DSAJ8866</b> ○ 32   ks
<b>DAK11867</b> ○ 94   m <sup>2</sup>	<b>DDM05867</b> ○ 72   set	<b>DCPVF867</b> ○ 86   ks	<b>DCPSR867</b> ○ 72   ks	<b>DCFVF867</b> ○ 114   ks	<b>DSAS3867</b> ○ 56   ks	<b>DSAPS867</b> ○ 54   ks	<b>DSAJ8867</b> ○ 32   ks
<b>DAK11864</b> ○ 94   m <sup>2</sup>	<b>DDM05864</b> ○ 72   set	<b>DCPVF864</b> ○ 86   ks	<b>DCPSR864</b> ○ 72   ks	<b>DCFVF864</b> ○ 114   ks	<b>DSAS3864</b> ○ 56   ks	<b>DSAPS864</b> ○ 54   ks	<b>DSAJ8864</b> ○ 32   ks
<b>DAK11865</b> ○ 94   m <sup>2</sup>	<b>DDM05865</b> ○ 72   set	<b>DCPVF865</b> ○ 86   ks	<b>DCPSR865</b> ○ 72   ks	<b>DCFVF865</b> ○ 114   ks	<b>DSAS3865</b> ○ 56   ks	<b>DSAPS865</b> ○ 54   ks	<b>DSAJ8865</b> ○ 32   ks
<b>DAK11870</b> ○ 94   m <sup>2</sup>	<b>DDM05870</b> ○ 72   set	<b>DCPVF870</b> ○ 86   ks	<b>DCPSR870</b> ○ 72   ks	<b>DCFVF870</b> ○ 114   ks	<b>DSAS3870</b> ○ 56   ks	<b>DSAPS870</b> ○ 54   ks	<b>DSAJ8870</b> ○ 32   ks
<b>DAK11869</b> ○ 94   m <sup>2</sup>	<b>DDM05869</b> ○ 72   set	<b>DCPVF869</b> ○ 86   ks	<b>DCPSR869</b> ○ 72   ks	<b>DCFVF869</b> ○ 114   ks	<b>DSAS3869</b> ○ 56   ks	<b>DSAPS869</b> ○ 54   ks	<b>DSAJ8869</b> ○ 32   ks
<b>DAK11868</b> ○ 94   m <sup>2</sup>	<b>DDM05868</b> ○ 72   set	<b>DCPVF868</b> ○ 86   ks	<b>DCPSR868</b> ○ 72   ks	<b>DCFVF868</b> ○ 114   ks	<b>DSAS3868</b> ○ 56   ks	<b>DSAPS868</b> ○ 54   ks	<b>DSAJ8868</b> ○ 32   ks
<b>DAK11871</b> ○ 94   m <sup>2</sup>	<b>DDM05871</b> ○ 72   set	<b>DCPVF871</b> ○ 86   ks	<b>DCPSR871</b> ○ 72   ks	<b>DCFVF871</b> ○ 114   ks	<b>DSAS3871</b> ○ 56   ks	<b>DSAPS871</b> ○ 54   ks	<b>DSAJ8871</b> ○ 32   ks
11	3	3	5	2	14	25	30
11	11	2,8	5,6	-	23,1	26,1	46,3
1,00	0,27	1,08	0,90	-	0,60	0,96	0,65
56	-	-	-	-	-	-	-
56,00	-	-	-	-	-	-	-
19,2	5,2	24,6	17,3	20,5	11,5	16,7	11,3
19,2	19,2	22,7	19,2	-	19,2	17,4	17,4
1 125	-	-	-	-	-	-	-

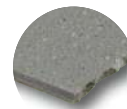

## culori / colors

60x120  
60x60

R10

B

V2

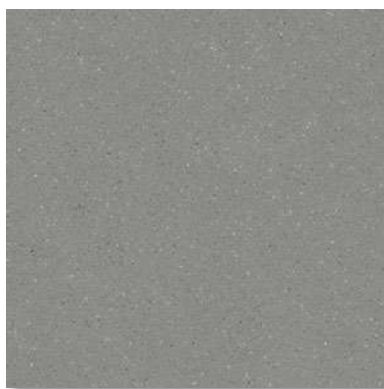

6493-0068 / DAKV1866    6461-0292 / DAK62866

### Shadow

PEI 4 mat | matt

gri închis / dark grey



6493-0069 / DAKV1867    6461-0293 / DAK62867

### Taupe

PEI 4 mat | matt

gri-bej / grey-beige

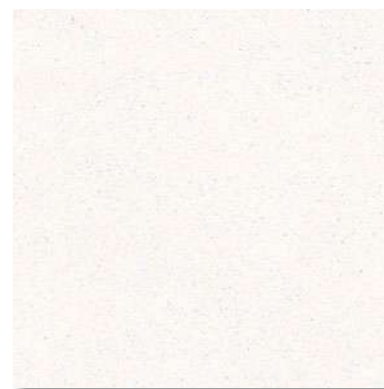

6493-0066 / DAKV1864    6461-0290 / DAK62864

### Paper

PEI 5 mat | matt

alb-gri / white-grey

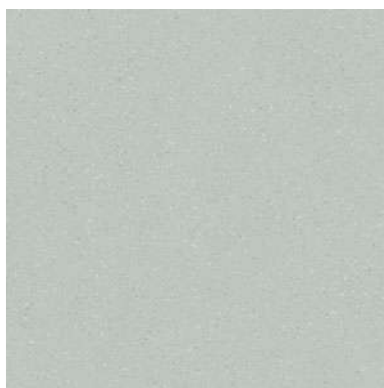

6493-0067 / DAKV1865    6461-0291 / DAK62865

### Cement

PEI 5 mat | matt

gri / grey



6493-0072 / DAKV1870    6461-0296 / DAK62870

### Storm

PEI 4 mat | matt

albastru închis / dark blue



6493-0071 / DAKV1869    6461-0295 / DAK62869

### Cotto

PEI 4 mat | matt

maro roșcat / brown-red

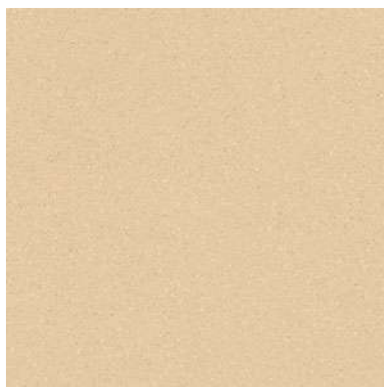

6493-0070 / DAKV1868    6461-0294 / DAK62868

### Sand

PEI 4 mat | matt

ocru / ochre



6493-0073 / DAKV1871    6461-0297 / DAK62871

### Coal

PEI 4 mat | matt

maro-negru / brown-black



suprafețe / surfaces

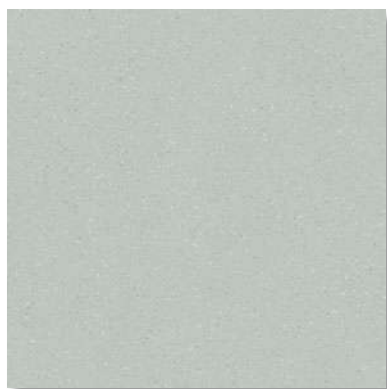

ABS

R10/B  
 $\mu \geq 0,6$

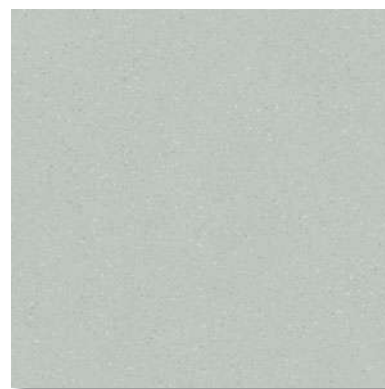

R11/B  
 $\mu \geq 0,6$

News

Object

RAKO



## piese speciale / special pieces

**treaptă** / step tile | **DCPVF...** | 298×1198×10 mm

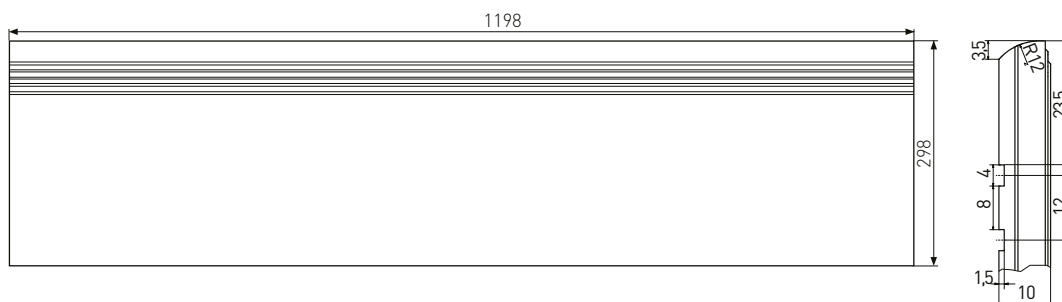

**treaptă** / step tile | **DCPSR...** | 298×598×9 mm

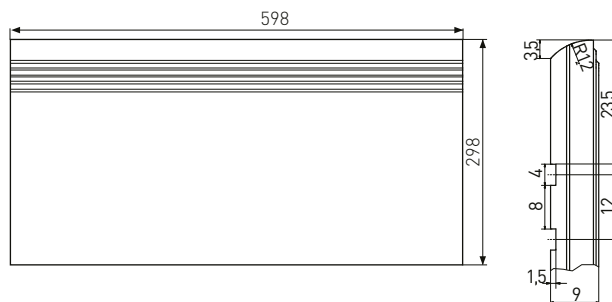

**treaptă specială** / special step tile | **DCFVF...** | 298×1198×10 mm

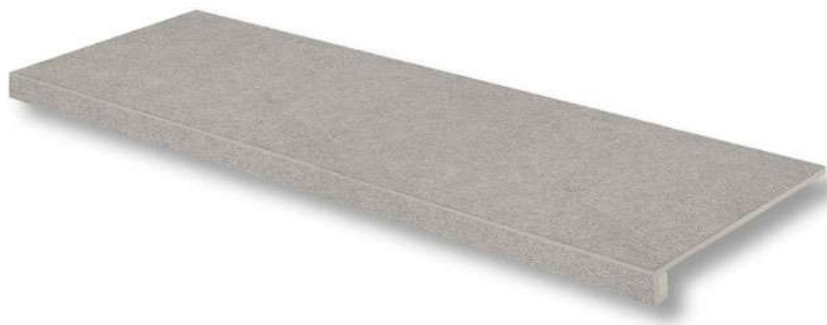
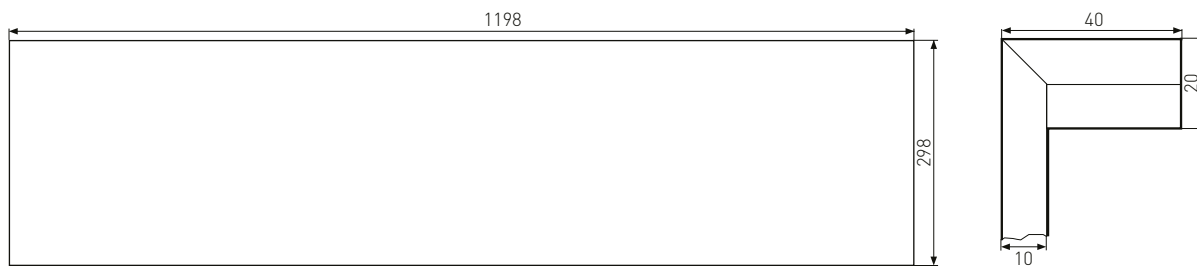





**plintă** / skirting plinth | **DSAS3...** | 598×72×9 mm

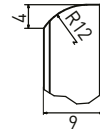
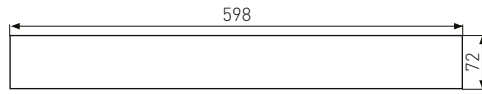

**plintă** / skirting plinth | **DSAPS...** | 448×85×8 mm

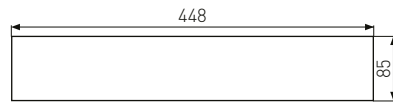

**plintă** / skirting plinth | **DSAJ8...** | 298×72×8 mm

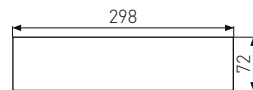

**compila**





News

RAKO Object





Produs / product



EN



gresie / floor tile  
gresie / floor tile

10×30  
60×60

98×298-8  
598×598×9

EN 14411 - H B1b  
EN 14411 - G Bla

24  
4

33,3  
2,8

0,72  
1,44

66  
32

47,52  
46,08

12,5  
27,6

17,4  
19,2

852  
910



## decor / decor | 98x298x8 mm

10x30



3029-0103/  
GARJD862  
○ 82 | m<sup>2</sup>  
lucios | glossy  
color **mint**  
verde deschis /  
light green



3029-0104/  
GARJD863  
○ 82 | m<sup>2</sup>  
lucios | glossy  
color **botanic**  
verde închis /  
dark green



3029-0102/  
GARJD861  
○ 82 | m<sup>2</sup>  
lucios | glossy  
color **aqua**  
albastru deschis /  
light blue



3029-0101/  
GARJD860  
○ 82 | m<sup>2</sup>  
lucios | glossy  
color **nude**  
roz deschis /  
light pink



3029-0107/  
GARJD867  
○ 82 | m<sup>2</sup>  
lucios | glossy  
color **taupe**  
gri-bej /  
grey-beige



3029-0105/  
GARJD864  
○ 82 | m<sup>2</sup>  
lucios | glossy  
color **paper**  
alb / white



3029-0106/  
GARJD865  
○ 82 | m<sup>2</sup>  
lucios | glossy  
color **cement**  
gri / grey



3029-0109/  
GARJD870  
○ 82 | m<sup>2</sup>  
lucios | glossy  
color **storm**  
albastru închis /  
dark blue



3029-0108/  
GARJD869  
○ 82 | m<sup>2</sup>  
lucios | glossy  
color **cotto**  
maro roșcat /  
brown-red

News

Object

RAKO

## decor / decor | 598x598x9 mm



6461-0298 / DAK62872  
PEI 4 ○ 88 | m<sup>2</sup>  
mat | matt  
multicolor / multicoloured



60x60

R10

B

V4

RE

ABS

# kaamos kaamos outdoor

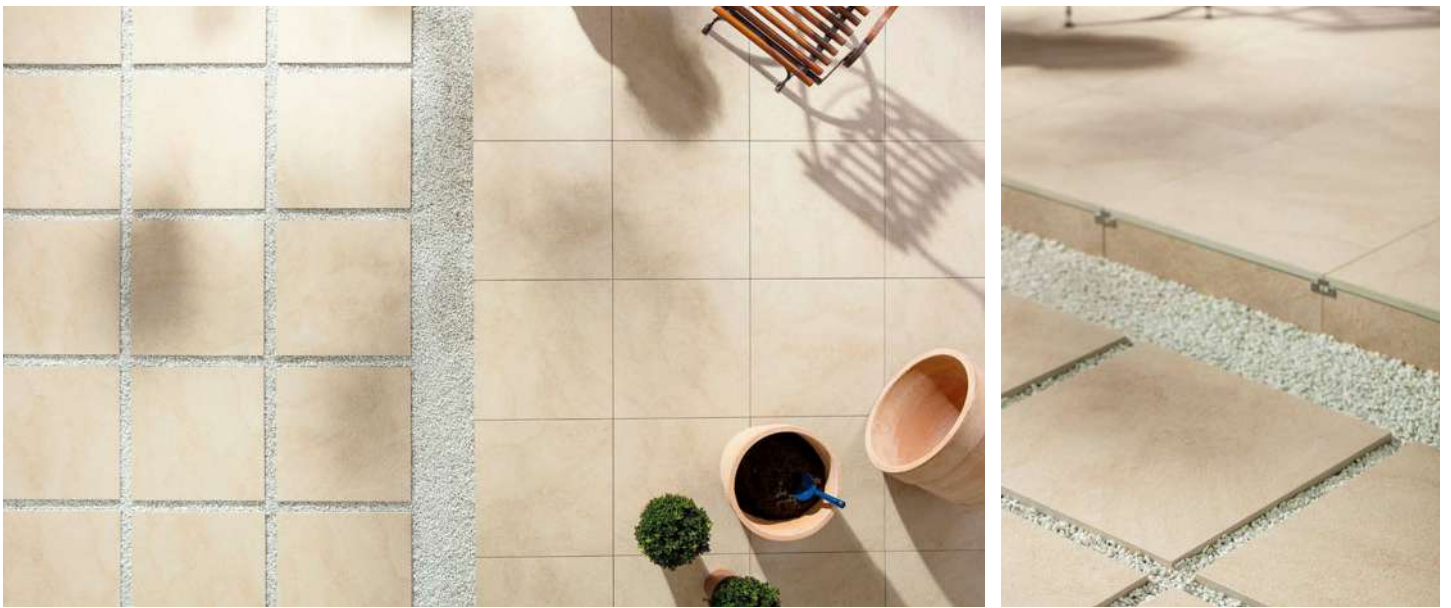

Înainte de a monta plăcile, vă sugerăm să selectați din mai multe cutii, să amestecați plăcile (inclusiv prin rotirea lor cu 180°) și să le aranjați așa cum este ilustrat în fotografia de inspirație sau să consultați site-ul [www.cesarom.ro](http://www.cesarom.ro).

Before laying the tiles, we suggest you select from several cartons and arrange them as illustrated in the inspiration photo documentation in RAKO catalogues or website [www.cesarom.ro](http://www.cesarom.ro).

There are two recommended laying patterns to choose from: one is a strictly one-way oriented design, and the other resembles a chessboard look achieved through a regular 90° turn tiling pattern.

produs / product	cm	mm	EN		pcs/m <sup>2</sup>	m <sup>2</sup>		m <sup>2</sup>	kg	kg/m <sup>2</sup>	brutto kg
gresie porțelanată / porcelain tile	60×60	598×598×10	EN 14411:2016, annex G Bla UGL		3	2,8	1,08	34,56	23,7	21,3	782
gresie porțelanată / porcelain tile	60×60	598×598×20	EN 14411:2016, annex G Bla UGL		2	2,8	0,72	30	21,60	32,0	985
plintă / plinth	60×9,5	598×95×10	EN 14411:2016, annex G Bla UGL		13	17,5	0,74	-	-	16,2	-
mozaic set 5×5 cm / mosaic sheet 5×5 cm	30×30	48×48×10	EN 14411:2016, annex L BIII UGL		3	11	0,27	-	-	5,9	-
treaptă / step tile	60×60	598×598×20	EN 14411:2016, annex G Bla UGL		2	-	-	-	-	32,0	-
treaptă / step tile	30×60	298×598×10	STO é. 030 - 059824		6	5,6	1,08	40	-	23,7	971

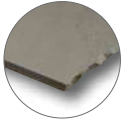

# kaamos outdoor



5461-0024 / DAK63586  
 mat / matt  
 bej / beige

6461-0182 / DAR66586  
 relief SR



5461-0025 / DAK63587  
 mat / matt  
 gri / gray

5461-0029 / DAR66587  
 relief SR

60x60  
 V3  
 UGL

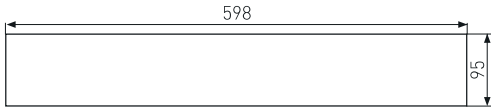

5706-0024 / DSAS4586 bej / beige  
 5706-0019 / DSAS4587 gri / gray  
 mat / matt



60x9,5  
 V3  
 UGL

Object

RAKO



5132-0107 / DDM06586  
 mat | matt  
 bej / beige



5132-0105 / DDM06587  
 mat | matt  
 gri / gray

30x30  
 R10  
 B  
 V3  
 UGL

30x60  
 R10  
 A  
 V3  
 R

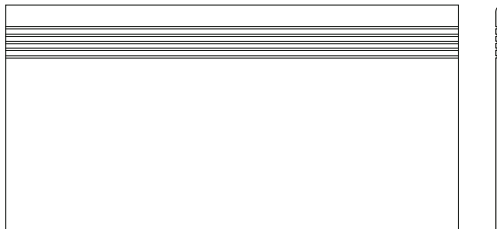

5860-0005 / DCPSE586 bej / beige  
 6860-0002 / DCPSE587 gri / gray  
 PEI 5  
 mat | matt

treaptă | step tile | 598x598x20 mm

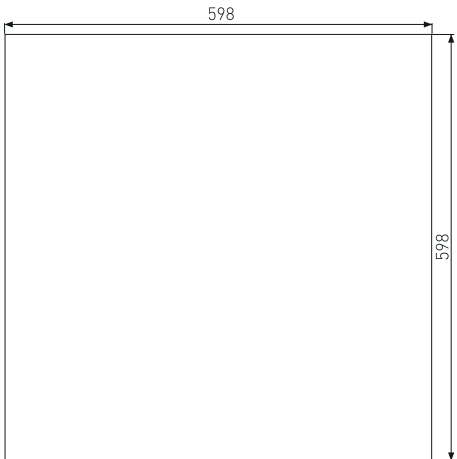

5861-0101 / DCH66586 bej / beige  
 5861-0102 / DCH66587 gri / gray  
 Structurat mat / Structured matt

20 mm

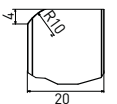

60x60  
 R11  
 B  
 V3  
 UGL



Quality, functionality, and durability were and are the important benefits of the Taurus GRANIT series.

The wide range, building on the ColorONE and ColorTWO assortments, supports the creative and variable potential of the individual projects, including a range of special supplies. All surfaces meet the high technical requirements of international standards.

„Proven quality.“





















Calitatea, funcționalitatea și durabilitatea au fost și continuă să fie beneficiile importante ale seriei Taurus GRANIT.

Gama largă, bazată pe sortimentele ColorONE și ColorTWO, susține potențialul creativ și variabil al proiectelor individuale, inclusiv o serie de consumabile speciale. Toate suprafețele îndeplinesc cerințele tehnice ridicate ale standardelor internaționale.

„Calitate dovedită.”

















# taurus granit





produs / product					
EN 14411 - G Bla	gresie / floor tile	gresie / floor tile	gresie / floor tile		
	<b>60×60</b> 	<b>30×60</b> 	<b>30×30</b>		
	598×598×10	298×598×10	298×298×8		
suprafață / surface	ABS	ABS	ABS	relief SR7	relief SRM
rezistență alunecare slip resistance	R10/B	R10/B	R10/B	R11/B	R12/B
coeficient de frecare la alunecare sliding friction coefficient	$\mu \geq 0,6$	$\mu \geq 0,6$	$\mu \geq 0,6$	$\mu \geq 0,7$	$\mu \geq 0,7$
culoare / color					
<b>69 Rio Negro</b> negru / black	TAK63069 ○ 78   m <sup>2</sup>	TAKSE069 ○ 78   m <sup>2</sup>	TAA34069 ○ 70   m <sup>2</sup>	TR734069 ○ 78   m <sup>2</sup>	TRM34069 ○ 80   m <sup>2</sup>
<b>65 Antracit</b> antracit-gri / anthracite-grey	TAK63065 ○ 78   m <sup>2</sup>	TAKSE065 ○ 78   m <sup>2</sup>	TAA34065 ○ 64   m <sup>2</sup>	TR734065 ○ 72   m <sup>2</sup>	TRM34065 ○ 74   m <sup>2</sup>
<b>76 Nordic</b> gri / grey	TAK63076 ○ 78   m <sup>2</sup>	TAKSE076 ○ 78   m <sup>2</sup>	TAA34076 ○ 64   m <sup>2</sup>	TR734076 ○ 72   m <sup>2</sup>	TRM34076 ○ 74   m <sup>2</sup>
<b>78 Sierra</b> gri deschis / light grey	TAK63078 ○ 82   m <sup>2</sup>	TAKSE078 ○ 78   m <sup>2</sup>	TAA34078 ○ 76   m <sup>2</sup>		
<b>60 Alaska</b> alb / white	TAK63060 ○ 88   m <sup>2</sup>	TAKSE060 ○ 84   m <sup>2</sup>	TAA34060 ○ 80   m <sup>2</sup>		
<b>62 Sahara</b> bej / beige	TAK63062 ○ 80   m <sup>2</sup>	TAKSE062 ○ 78   m <sup>2</sup>	TAA34062 ○ 74   m <sup>2</sup>		
<b>61 Tunis</b> bej închis / dark beige	TAK63061 ○ 78   m <sup>2</sup>	TAKSE061 ○ 78   m <sup>2</sup>	TAA34061 ○ 64   m <sup>2</sup>	TR734061 ○ 72   m <sup>2</sup>	TRM34061 ○ 74   m <sup>2</sup>
<b>68 Cuba</b> maro-gri / brown-grey	TAK63068 ○ 78   m <sup>2</sup>	TAKSE068 ○ 78   m <sup>2</sup>	TAA34068 ○ 72   m <sup>2</sup>	TR734068 ○ 78   m <sup>2</sup>	
<b>74 Gobi</b> galben / yellow			TAA34074 ○ 74   m <sup>2</sup>		
<b>82 Jura</b> roșu / red			TAA34082 ○ 76   m <sup>2</sup>		
<b>80 Oaza</b> verde / green			TAA34080 ○ 74   m <sup>2</sup>		
<b>75 Biskay</b> albastru / blue			TAA34075 ○ 74   m <sup>2</sup>		
<b>informații logistice / logistic information</b>					
	3	6	14		
	2,8	5,6	11,0		
	1,08	1,08	1,27		
	32	40	48		
	34,56	43,20	60,96		
	23,7	23,7	21,6		
	21,9	21,9	17,0		
	782	971	1 062		



# taurus granit











produs / product						
STO Ć. 030 - 059824	<b>treaptă /</b> step tile	<b>treaptă /</b> step tile	<b>treaptă exterior /</b> ext. step tile	<b>plintă /</b> skirting plinth	<b>plintă /</b> skirting plinth	<b>plintă franceză  </b> french skirting plinth
	<b>30×60</b> 	<b>30×30</b>	<b>30×30</b>	<b>60×9,5</b> 	<b>30×8</b>	<b>30×8</b>
	298×598×10	298×298×8	298×298×8	598×95×10	298×80×8	298×80×8
<b>suprafață / surface</b>	ABS	ABS	relief SR7	ABS	ABS	ABS
<b>rezistentă la alunecare</b> slip resistance	R10/B	R10/B	R11/B			
<b>coeficient de frecare la alunecare</b> sliding friction coefficient	$\mu \geq 0,7$	$\mu \geq 0,7$	$\mu \geq 0,7$			
<b>culoare / color</b>						
<b>69 Rio Negro</b> negru / black	TCPSE069 ○ 72   ks	TCA34069 ○ 19   ks	TCV34069 ○ 44   ks	TSASZ069 ○ 50   ks	TSAKF069 ○ 19   ks	TSFKF069 ○ 30   ks
<b>65 Antracit</b> antracit-gri / anthracite-grey	TCPSE065 ○ 72   ks	TCA34065 ○ 16   ks	TCV34065 ○ 44   ks	TSASZ065 ○ 50   ks	TSAKF065 ○ 19   ks	TSFKF065 ○ 30   ks
<b>76 Nordic</b> gri / grey	TCPSE076 ○ 72   ks	TCA34076 ○ 16   ks	TCV34076 ○ 44   ks	TSASZ076 ○ 50   ks	TSAKF076 ○ 19   ks	TSFKF076 ○ 30   ks
<b>78 Sierra</b> gri deschis / light grey	TCPSE078 ○ 72   ks	TCA34078 ○ 22   ks		TSASZ078 ○ 50   ks	TSAKF078 ○ 19   ks	TSFKF078 ○ 30   ks
<b>60 Alaska</b> alb / white	TCPSE060 ○ 72   ks	TCA34060 ○ 22   ks		TSASZ060 ○ 50   ks	TSAKF060 ○ 19   ks	
<b>62 Sahara</b> bej / beige	TCPSE062 ○ 72   ks	TCA34062 ○ 19   ks		TSASZ062 ○ 50   ks	TSAKF062 ○ 19   ks	TSFKF062 ○ 30   ks
<b>61 Tunis</b> bej închis / dark beige	TCPSE061 ○ 72   ks	TCA34061 ○ 16   ks	TCV34061 ○ 44   ks	TSASZ061 ○ 50   ks	TSAKF061 ○ 19   ks	TSFKF061 ○ 30   ks
<b>68 Cuba</b> maro-gri / brown-grey	TCPSE068 ○ 72   ks	TCA34068 ○ 20   ks		TSASZ068 ○ 50   ks	TSAKF068 ○ 19   ks	TSFKF068 ○ 30   ks
<b>74 Gobi</b> galben / yellow		TCA34074 ○ 22   ks			TSAKF074 ○ 19   ks	
<b>82 Jura</b> roșu / red		TCA34082 ○ 22   ks			TSAKF082 ○ 19   ks	
<b>80 Oaza</b> verde / green		TCA34080 ○ 20   ks			TSAKF080 ○ 19   ks	
<b>75 Biskay</b> albastru / blue		TCA34075 ○ 22   ks			TSAKF075 ○ 19   ks	
<b>informații logistice /</b> logistic information						
	6	14	13	13	23	22
	5,6	11,0	11,0	17,5	42,0	42,0
	1,08	1,27	1,18	0,74	0,55	0,53
	40	48	52	-	-	-
	43,20	60,96	61,36	-	-	-
	23,7	21,7	19,5	16,2	9,4	9,0
	21,9	17,0	17,0	21,9	17,0	17,0
	971	1 062	1 039	-	-	-



 plintă cove / cove skirting	 plintă cove / cove skirting	 colț interior plintă / inside corner skirting plinth	 colț exterior plintă / outside corner skirting plinth
<b>30×8</b>	<b>20×8</b>	<b>2,3×8</b>	<b>2,3×8</b>
298×80×8	198×80×8	80×23×10	80×23×7
ABS	ABS	S	S
R10/B	R10/B		
$\mu \geq 0,6$	$\mu \geq 0,6$		
TSPKF069 ○ 28   ks	TSPF6069 ○ 22   ks	TSIRH069 ○ 46   ks	TSERH069 ○ 46   ks
TSPKF065 ○ 28   ks	TSPF6065 ○ 22   ks	TSIRH065 ○ 46   ks	TSERH065 ○ 46   ks
TSPKF076 ○ 28   ks	TSPF6076 ○ 22   ks	TSIRH076 ○ 46   ks	TSERH076 ○ 46   ks
TSPKF078 ○ 28   ks		TSIRH078 ○ 46   ks	TSERH078 ○ 46   ks
TSPKF062 ○ 28   ks	TSPF6062 ○ 22   ks	TSIRH062 ○ 46   ks	TSERH062 ○ 46   ks
TSPKF061 ○ 28   ks	TSPF6061 ○ 22   ks	TSIRH061 ○ 46   ks	TSERH061 ○ 46   ks
TSPKF068 ○ 28   ks	TSPF6068 ○ 22   ks	TSIRH068 ○ 46   ks	TSERH068 ○ 46   ks
19	28	150	100
42,0	62,5	-	-
0,46	0,45	-	-
-	-	-	-
-	-	-	-
7,8	7,6	4,5	3,5
17,0	17,0	-	-
-	-	-	-





produs / product			
STO ě. 030 - 059824	<b>piesă colt de duș cu pantă</b> / shower piece corner	<b>piesă de duș cu pantă</b> / shower piece continuous	<b>jgheab</b> / skirting groove
	<b>10×10</b>	<b>10×10</b>	<b>20×7</b>
	98×98×8	98×98×8	198×70×8
suprafață / surface	ABS	ABS	S
rezistență la alunecare slip resistance	R10/B	R10/B	
coeficient de frecare la alunecare sliding friction coefficient	$\mu \geq 0,6$	$\mu \geq 0,6$	
color / color			
<b>69 Rio Negro</b> negru / black	TTR11069 ○ 52   ks	TTP11069 ○ 52   ks	TSZEF069 ○ 22   ks
<b>65 Antracit</b> antracit-gri / anthracite-grey	TTR11065 ○ 52   ks	TTP11065 ○ 52   ks	TSZEF065 ○ 22   ks
<b>76 Nordic</b> gri / grey	TTR11076 ○ 52   ks	TTP11076 ○ 52   ks	TSZEF076 ○ 22   ks
<b>78 Sierra</b> gri deschis / light grey			
<b>60 Alaska</b> alb / white			
<b>62 Sahara</b> bej / beige			
<b>61 Tunis</b> bej închis / dark beige	TTR11061 ○ 52   ks	TTP11061 ○ 52   ks	TSZEF061 ○ 22   ks
<b>68 Cuba</b> maro-gri / brown-grey			
<b>74 Gobi</b> galben / yellow			
<b>82 Jura</b> roșu / red			
<b>80 Oaza</b> verde / green			
<b>75 Biskay</b> albastru / blue			
<b>informații logistice</b> / logistic information			
	16	16	24
	100,0	100,0	71,0
	0,16	0,16	0,34
	-	-	-
	-	-	-
	3,5	3,2	7,2
			21,2
	-	-	-

# taurus granit



suprafețe / surfaces



ABS

R10/B  
 $\mu \geq 0,6$



relief  
SR7

R11/B  
 $\mu \geq 0,7$

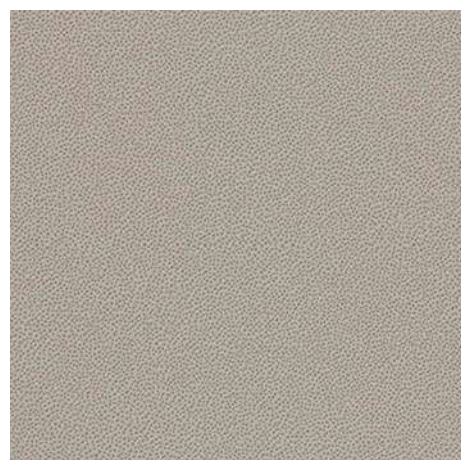

relief  
SRM

R12/B  
 $\mu \geq 0,7$





RAKO Object

\* Pentru un efect optim este recomandat să montați placile într-o singură direcție. / For optimal effect, the laying of individual tiles in one direction is recommended.



5032-0337 / TAA34061  
mat | matt  
bej închis / dark beige

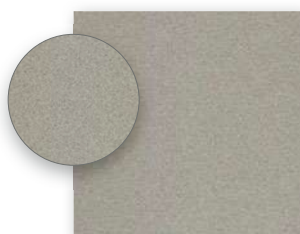

5032-0339 / TAA34076  
mat | matt  
gri / gray

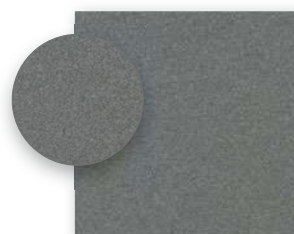

5032-0338 / TAA34065  
mat | matt  
gri antracit / anthracite gray

30x30  
R10  
B  
V2  
UGL

**ABS** – Suprafață fină cu rezistență la alunecare R10/B / Smooth slip-resistant surface R10/B  
**SR** – Relief / Relief surface

produs / product



EN



gresie porțelanată / porcelain tile

30x30

298x298x10

EN 14411:2016, annex G Bla UGL

14

11,0

1,27

48

60,96

21,6

17,0

1062

# taurus **granit**



culori / colors



**69 Rio Negro**  
negru / black

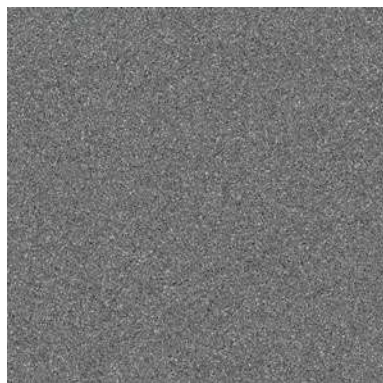

**65 Antracit**  
antracit-gri / anthracite grey



**76 Nordic**  
gri / grey



**78 Sierra**  
gri deschis / light grey



**60 Alaska**  
alb / white



**62 Sahara**  
bej / beige



**61 Tunis**  
bej închis / dark beige

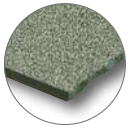

**68 Cuba**  
maro-gri / brown-grey



**74 Gobi**  
galben / yellow



**82 Jura**  
roșu / red



**80 Oaza**  
verde / green



**75 Biskay**  
albastru / blue

# taurus **granit**



piese speciale / special pieces

**treaptă** / step tile | **TCPSE...** | 298x598x10 mm | 

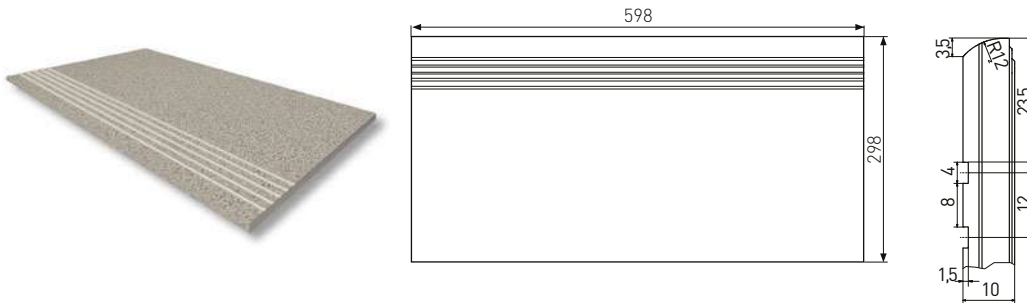

**treaptă** / step tile | **TCA34...** | 298x298x8 mm | 

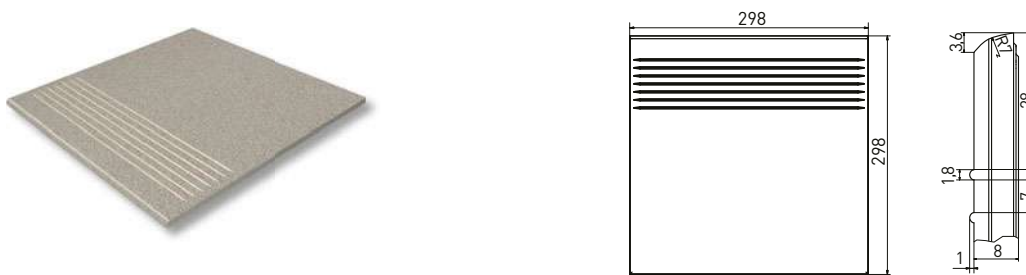

**treaptă exterioră** / outside step tile | **TCV34...** | 298x298x8 mm





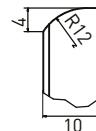
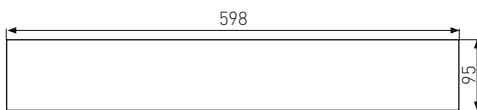

plintă / skirting plinth | **TSASZ...** | 598x95x10 mm | 

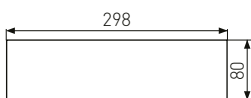

plintă / skirting plinth | **TSAKF...** | 298x80x8 mm | 



plintă franceză / french skirting | **TSEKF...** | 298x80x8 mm | 

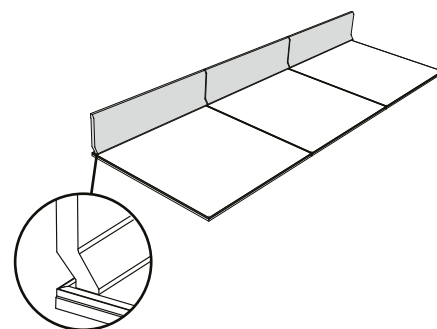
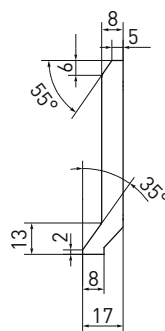
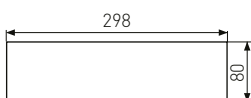



## piese speciale / special pieces

plintă cove / cove skirting | **TSPKF...** | 298×80×8 mm | 

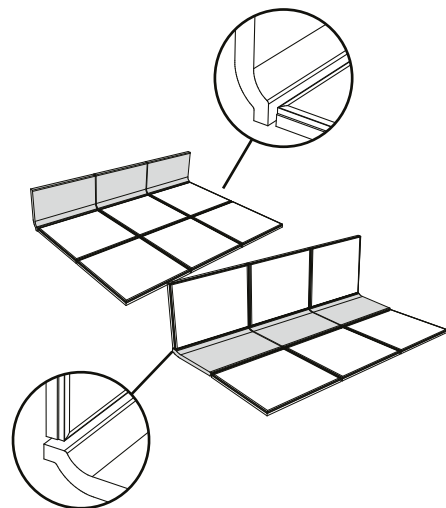
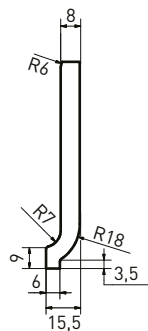
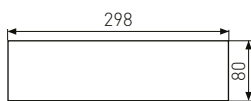

colț interior plintă / inside corner cove skirting | **TSIRH...** | 80×23×10 mm

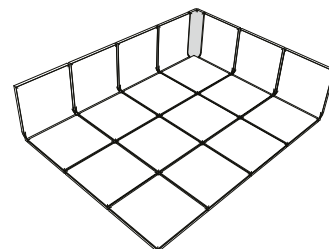
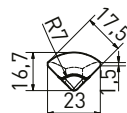
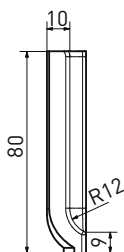

colț exterior plintă / outside corner cove skirting | **TSERH...** | 80×23×7 mm

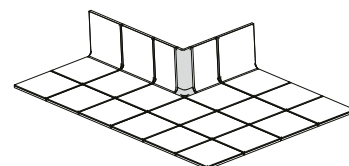
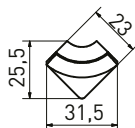
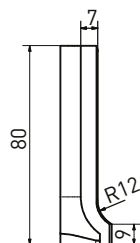

plintă cove / cove skirting | **TSPF6...** | 198×80×8 mm | 

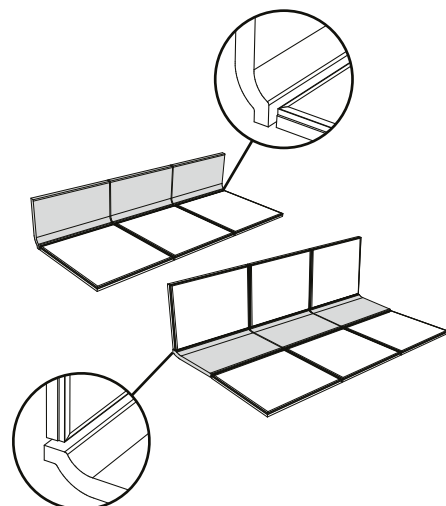
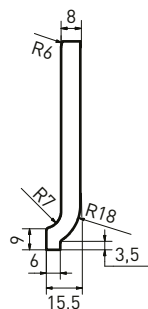
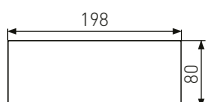



piese speciale / special pieces

piesă colț de duș cu pantă / shower piece - corner | **TTR11...** | 98×98×8 mm |

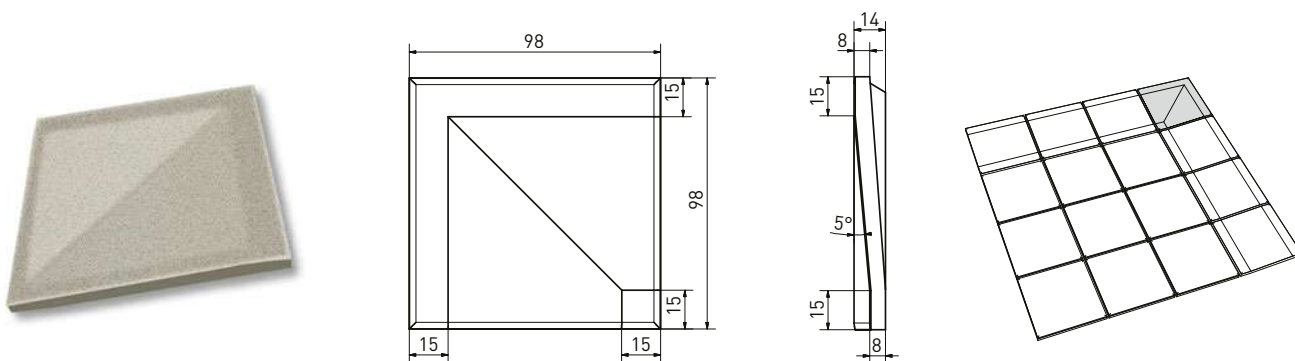

piesă de duș cu pantă / shower piece - continuous | **TTP11...** | 98×98×8 mm |

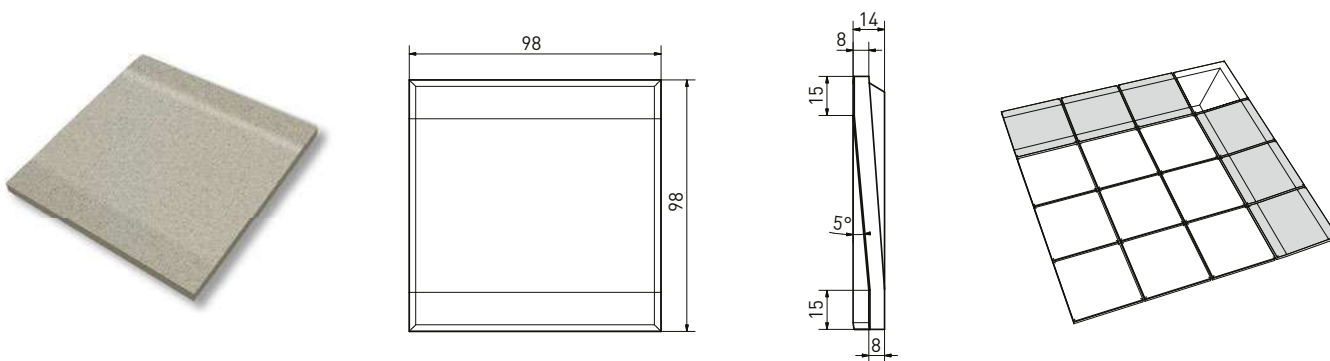

igheab / skirting - groove | **TSZEF...** | 198×70×8 mm

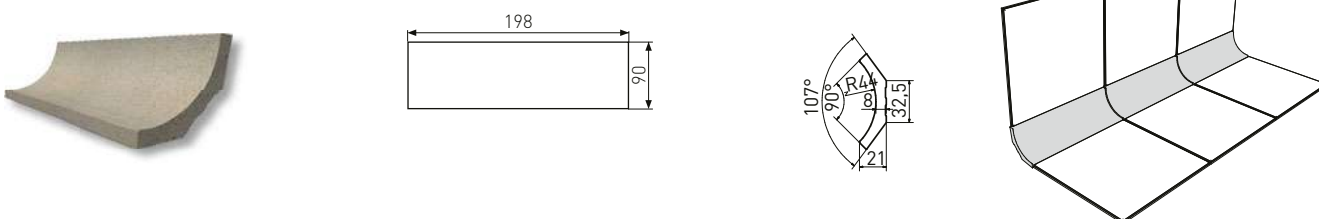



Taurus INDUSTRIAL is a comprehensive range of mainly technical reliefs. Highly sintered unglazed ceramic tiles with excellent parameters are designed for buildings with extreme conditions such as food processing factories, industrial areas with high mechanical and chemical strains.

„Maximum resistance.“





















Taurus INDUSTRIAL reprezintă o gamă cuprinzătoare, axată în principal pe relieful tehnice.

Plăcile ceramice neporțelante sinterizate și cu parametri excelenți, sunt proiectate pentru clădiri expuse la condiții extreme, cum ar fi fabricile de procesare a alimentelor, zonele industriale cu solicitări mecanice și chimice ridicate.

„Rezistență maximă.”



# taurus industrial

produs   product								
EN 14411 - GBla	gresie / floor tile	gresie / floor tile						
	<b>30×30</b>	<b>20×20</b>						
	298×298×14	198×198×14						
suprafață / surface	ABS	ABS	relief SRM 	relief SR1	relief SR2	relief SR4	relief SR7 	relief SR20
rezistență la alunecare slip resistance	R10/B	R10/B	R12/B	R11/B V4	R12/B V4	R12/C V4	R11/B	R13/C V8
coeficient de frecare la alunecare sliding friction coefficient	$\mu \geq 0,6$	$\mu \geq 0,6$	$\mu \geq 0,7$	$\mu \geq 0,7$	$\mu \geq 0,7$	$\mu \geq 0,7$	$\mu \geq 0,7$	$\mu \geq 0,7$
barva / color								
<b>65 Antracit</b> antracit gri anthracite grey	TAA3V065 ○ 88   m <sup>2</sup>	TAA2Z065 ○ 88   m <sup>2</sup>	TRM2Z065 ○ 90   m <sup>2</sup>	TR12Z065 ○ 90   m <sup>2</sup>	TR22Z065 ○ 90   m <sup>2</sup>	TR42Z065 ○ 90   m <sup>2</sup>	TR72Z065 ○ 90   m <sup>2</sup>	TRA2Z065 ○ 90   m <sup>2</sup>
<b>76 Nordic</b> gri / grey	TAA3V076 ○ 88   m <sup>2</sup>	TAA2Z076 ○ 88   m <sup>2</sup>	TRM2Z076 ○ 90   m <sup>2</sup>	TR12Z076 ○ 90   m <sup>2</sup>	TR22Z076 ○ 90   m <sup>2</sup>	TR42Z076 ○ 90   m <sup>2</sup>	TR72Z076 ○ 90   m <sup>2</sup>	TRA2Z076 ○ 90   m <sup>2</sup>
<b>61 Tunis</b> bej închis dark beige	TAA3V061 ○ 88   m <sup>2</sup>	TAA2Z061 ○ 88   m <sup>2</sup>		TR12Z061 ○ 90   m <sup>2</sup>	TR22Z061 ○ 90   m <sup>2</sup>	TR42Z061 ○ 90   m <sup>2</sup>		TRA2Z061 ○ 90   m <sup>2</sup>
informații logistice / logistic information								
	8				18			
	11,0				25,0			
	0,72				0,72			
	48				54			
	34,56				38,88			
	23,2				21,6			
	32,3				30,0			
	1 140				1 192			



gresie /  
floor tile

**20×20**

198×198×8

relief SR1	relief SR2	relief SR4	relief SR20
R11/B V4	R12/B V4	R12/C V4	R13/C V8
$\mu \geq 0,7$	$\mu \geq 0,7$	$\mu \geq 0,7$	$\mu \geq 0,7$
TR125065 ○ 78   m <sup>2</sup>	TR225065 ○ 78   m <sup>2</sup>	TR425065 ○ 78   m <sup>2</sup>	TRA25065 ○ 80   m <sup>2</sup>
TR125076 ○ 78   m <sup>2</sup>	TR225076 ○ 78   m <sup>2</sup>	TR425076 ○ 78   m <sup>2</sup>	TRA25076 ○ 80   m <sup>2</sup>
TR125061 ○ 78   m <sup>2</sup>	TR225061 ○ 78   m <sup>2</sup>	TR425061 ○ 78   m <sup>2</sup>	TRA25061 ○ 80   m <sup>2</sup>
		32	
		25,0	
		1,28	
		54	
		69,12	
		21,8	
		17,0	
		1 200	

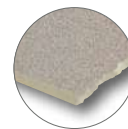

culori / colors

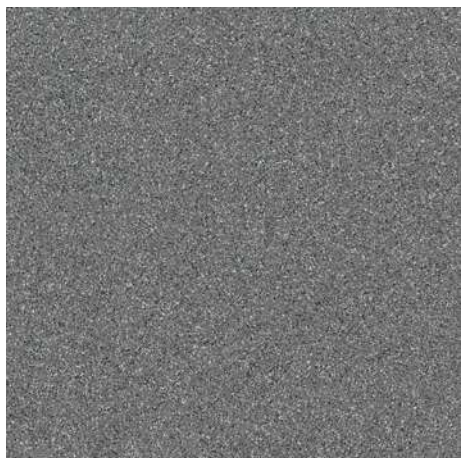

**65 Antracit**  
antracit gri / anthracite grey



**76 Nordic**  
gri / grey



**61 Tunis**  
bej închis / dark beige



suprafețe / surfaces



ABS

R10/B  
 $\mu \geq 0,6$



relief  
SRM

R12/B  
 $\mu \geq 0,7$



relief  
SR1

R11/B V4  
 $\mu \geq 0,7$



relief  
SR2

R12/B V4  
 $\mu \geq 0,7$

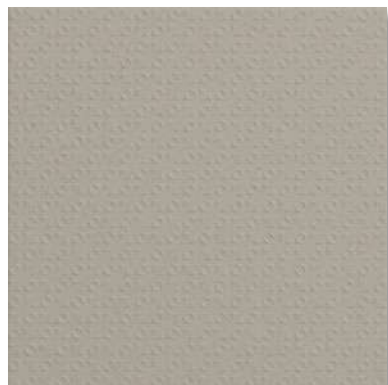

relief  
SR4

R12/C V4  
 $\mu \geq 0,7$



relief  
SR7

R11/B  
 $\mu \geq 0,7$

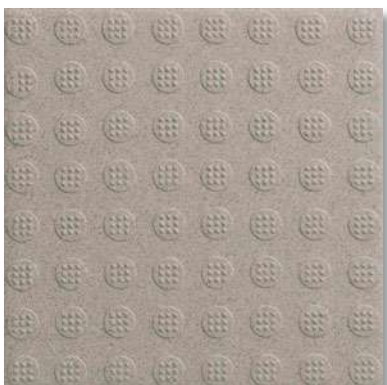

relief  
SR20

R13/C V8  
 $\mu \geq 0,7$

RAKO Object



The highly sintered unglazed single-colour tiles of the Taurus COLOR series are the benchmark of our high level production. The uncompromising quality, variety of tile surfaces, and technical supplies allow the tiles to be used not only in modern, timeless interiors but also in spaces with higher functional requirements as well. The series also includes ceramic shaped bricks for the visually impaired and blind.

„Harmony without limits.“





Plăcile monocrome neporțelante, sinterizate din seria Taurus COLOR, reprezintă reperul nostru în producția de înaltă calitate.

Calitatea fără compromisuri, varietatea suprafețelor plăcilor și accesoriile tehnice permit utilizarea acestora nu doar în interioare moderne și atemporale, ci și în spații cu cerințe funcționale mai ridicate.

Seria include de asemenea plăci ceramice cu suprafețe destinate traseelor pentru persoanele cu deficiențe de vedere.

„Armonie fără limite.”













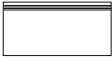
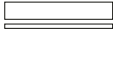





taurus **color**













produs / product							
EN 14411 - G Bla	gresie / floor tile	gresie / floor tile	gresie / floor tile	gresie / floor tile	gresie / floor tile	mozaic set 30x30 cm / mosaic sheet 30x30 cm	
	60x60	30x60	30x30	20x20	10x10	5x5	
	598x598x10	298x598x10	298x298x8	198x198x8	98x98x8	48x48x8	
suprafață / surface	ABS	ABS	ABS	relief SR7	ABS	ABS	
rezistență la alunecare slip resistance	R10/B	R10/B	R10/B	R11/B	R10/B	R10/B	
coeficient de frecare sliding friction coefficient	$\mu > 0,6$	$\mu > 0,6$	$\mu > 0,6$	$\mu \geq 0,7$	$\mu \geq 0,6$	$\mu \geq 0,6$	
culoare / color							
<b>19 Black</b> negru / black	TAK63019 ○ 88   m <sup>2</sup>	TAKSE019 ○ 84   m <sup>2</sup>	TAA34019 ○ 82   m <sup>2</sup>	TR734019 ○ 84   m <sup>2</sup>	TAA25019 ○ 82   m <sup>2</sup>	TAA11019 ○ 90   m <sup>2</sup>	TDM05019 ○ 68   set
<b>07 Dark Grey</b> gri închis / dark grey	TAK63007 ○ 88   m <sup>2</sup>	TAKSE007 ○ 84   m <sup>2</sup>	TAA34007 ○ 78   m <sup>2</sup>	TR734007 ○ 80   m <sup>2</sup>	TAA25007 ○ 80   m <sup>2</sup>	TAA11007 ○ 88   m <sup>2</sup>	TDM05007 ○ 68   set
<b>06 Grey</b> gri / grey	TAK63006 ○ 88   m <sup>2</sup>	TAKSE006 ○ 84   m <sup>2</sup>	TAA34006 ○ 78   m <sup>2</sup>	TR734006 ○ 80   m <sup>2</sup>	TAA25006 ○ 80   m <sup>2</sup>	TAA11006 ○ 88   m <sup>2</sup>	TDM05006 ○ 68   set
<b>03 Light Grey</b> gri deschis / light grey	TAK63003 ○ 88   m <sup>2</sup>		TAA34003 ○ 82   m <sup>2</sup>	TR734003 ○ 84   m <sup>2</sup>	TAA25003 ○ 82   m <sup>2</sup>	TAA11003 ○ 90   m <sup>2</sup>	TDM05003 ○ 68   set
<b>11 White</b> alb / white	TAK63011 ○ 92   m <sup>2</sup>		TAA34011 ○ 86   m <sup>2</sup>		TAA25011 ○ 86   m <sup>2</sup>	TAA11011 ○ 94   m <sup>2</sup>	TDM05011 ○ 68   set
<b>10 Ivory</b> ivoriu / ivory	TAK63010 ○ 88   m <sup>2</sup>		TAA34010 ○ 78   m <sup>2</sup>	TR734010 ○ 80   m <sup>2</sup>	TAA25010 ○ 80   m <sup>2</sup>	TAA11010 ○ 88   m <sup>2</sup>	TDM05010 ○ 68   set
<b>25 Tobacco</b> maro-gri brown-grey	TAK63025 ○ 88   m <sup>2</sup>		TAA34025 ○ 78   m <sup>2</sup>	TR734025 ○ 80   m <sup>2</sup>	TAA25025 ○ 80   m <sup>2</sup>	TAA11025 ○ 88   m <sup>2</sup>	TDM05025 ○ 68   set
informații logistice / logistic information							
	3	6	14	32	12	4	
ks/m <sup>2</sup>	2,8	5,6	11,0	25,0	11,0	11,0	
m <sup>2</sup>	1,08	1,08	1,27	1,28	1,09	0,36	
	32	40	48	54	56	-	
m <sup>2</sup>	34,56	43,20	60,96	69,12	61,04	-	
kg	23,7	23,7	21,6	21,8	18,5	6,0	
kg/m <sup>2</sup>	21,9	21,9	17,0	17,0	17,0	17,0	
brutto kg	782	971	1 062	1 200	1 063	-	

product / product							
STO Ā. 030-059824	<b>treaptă /</b> step tile	<b>treaptă cu înălțător /</b> step piece with riser	<b>gresie specială /</b> special floor tile	<b>treaptă /</b> step tile	<b>plintă /</b> skirting plinth	<b>plintă /</b> skirting plinth	
	<b>30×60</b> 	<b>60×5</b>  <b>60×2</b>	<b>30×30</b>	<b>30×30</b>	<b>60×9</b> 	<b>30×8</b>	
	298×598×10	598×50×10 598×20×10	298×298×9	298×298×8	598×95×10	298×80×8	
<b>suprafață / surface</b>	ABS	ABS	relief go	relief stop	ABS	ABS	
<b>rezistență la alunecare</b> slip resistance	R10/B	R10/B	R11/A	R11/A	R10/B		
<b>coeficient de frecare la alunecare</b> sliding friction coefficient	$\mu \geq 0,7$	$\mu \geq 0,7$	$\mu \geq 0,7$	$\mu \geq 0,7$	$\mu \geq 0,7$		
<b>culoare / color</b>							
<b>19 Black</b> negru / black	TCPSE019 ○ 72   ks	TCPVN019 ○ 76   set	TTG35019 ○ 78   ks	TTS35019 ○ 78   ks	TCP34019 ○ 44   ks	TSASZ019 ○ 50   ks	TSAKF019 ○ 19   ks
<b>07 Dark Grey</b> gri închis dark grey	TCPSE007 ○ 72   ks				TCP34007 ○ 44   ks	TSASZ007 ○ 50   ks	TSAKF007 ○ 19   ks
<b>06 Grey</b> gri / grey	TCPSE006 ○ 72   ks				TCP34006 ○ 44   ks	TSASZ006 ○ 50   ks	TSAKF006 ○ 19   ks
<b>03 Light Grey</b> gri deschis / light grey	TCPSE003 ○ 72   ks				TCP34003 ○ 44   ks	TSASZ003 ○ 50   ks	TSAKF003 ○ 19   ks
<b>11 White</b> alb / white	TCPSE011 ○ 72   ks				TCP34011 ○ 46   ks	TSASZ011 ○ 50   ks	TSAKF011 ○ 19   ks
<b>10 Ivory</b> ivoriu / ivory	TCPSE010 ○ 72   ks	TCPVN010 ○ 76   set	TTG35010 ○ 78   ks	TTS35010 ○ 78   ks	TCP34010 ○ 44   ks	TSASZ010 ○ 50   ks	TSAKF010 ○ 19   ks
<b>25 Tobacco</b> maro-gri / brown-grey	TCPSE025 ○ 72   ks				TCP34025 ○ 44   ks	TSASZ025 ○ 50   ks	TSAKF025 ○ 19   ks
<b>informații logistice /</b> logistic information							
	6	16	9	13	13	23	
	5,6	-	11,0	11,0	17,5	42,0	
	1,08	-	0,81	1,18	0,74	0,55	
	40	-	42	52	-	-	
	43,20	-	34,36	61,36	-	-	
	23,7	15,2	18,0	19,5	16,2	9,4	
	21,9	21,9	22,2	17,0	21,9	17,0	
	971	-	780	1 039	-	-	



					
plintă cove / cove skirting	plintă cove / cove skirting	colț interior plintă cove / inside corner cove skirting	colț exterior plintă cove / outside corner cove skirting	piesă colț de duș cu pantă / shower piece corner	piesă de duș cu pantă / shower piece continuous
30×8	20×8	2,3×8	2,3×8	10×10	10×10
298×80×8	198×80×8	80×23×10	80×23×7	98×98×8	98×98×8
ABS	ABS	S	S	ABS	ABS
R10/B	R10/B			R10/B	R10/B
μ ≥ 0,6	μ ≥ 0,6			μ ≥ 0,6	μ ≥ 0,6
TSPKF019 ○ 28   ks	TSPF6019 ○ 22   ks	TSIRH019 ○ 46   ks	TSERH019 ○ 46   ks	TTR11019 ○ 52   ks	TTP11019 ○ 52   ks
TSPKF007 ○ 28   ks	TSPF6007 ○ 22   ks	TSIRH007 ○ 46   ks	TSERH007 ○ 46   ks	TTR11007 ○ 52   ks	TTP11007 ○ 52   ks
TSPKF006 ○ 28   ks	TSPF6006 ○ 22   ks	TSIRH006 ○ 46   ks	TSERH006 ○ 46   ks	TTR11006 ○ 52   ks	TTP11006 ○ 52   ks
TSPKF003 ○ 28   ks	TSPF6003 ○ 22   ks	TSIRH003 ○ 46   ks	TSERH003 ○ 46   ks	TTR11003 ○ 52   ks	TTP11003 ○ 52   ks
TSPKF010 ○ 28   ks	TSPF6010 ○ 22   ks	TSIRH010 ○ 46   ks	TSERH010 ○ 46   ks	TTR11010 ○ 52   ks	TTP11010 ○ 52   ks
TSPKF025 ○ 28   ks	TSPF6025 ○ 22   ks	TSIRH025 ○ 46   ks	TSERH025 ○ 46   ks	TTR11025 ○ 52   ks	TTP11025 ○ 52   ks
19	28	150	100	16	16
42,0	62,5	-	-	100,0	100,0
0,46	0,45	-	-	0,16	0,16
-	-	-	-	-	-
-	-	-	-	-	-
7,8	7,6	4,5	3,5	3,5	3,2
17,0	17,0	-	-	-	-
-	-	-	-	-	-

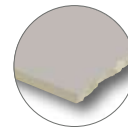

## culori / colors



**19 Black**  
negru / black

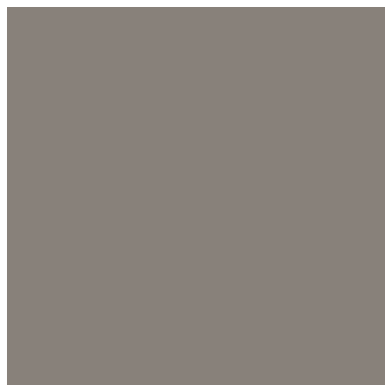

**07 Dark Grey**  
gri inchis / dark grey



**06 Grey**  
gri / grey



**03 Light Grey**  
gri deschis / light grey

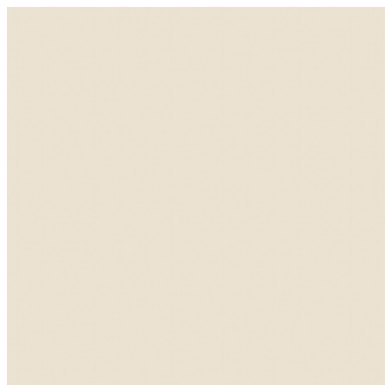

**11 White**  
alb / white



**10 Ivory**  
ivoriu / ivory

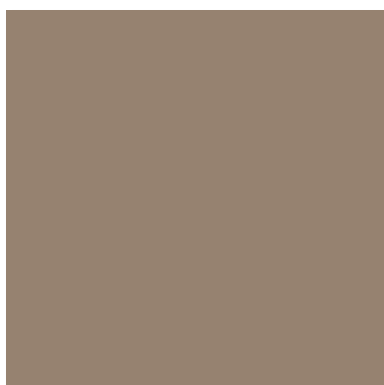

**25 Tobacco**  
maro-gri / brown-grey



suprafețe / surfaces

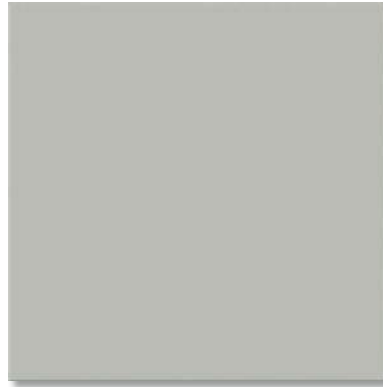

ABS

R10/B  
 $\mu \geq 0,6$



relief  
SR7

R11/B  
 $\mu \geq 0,7$

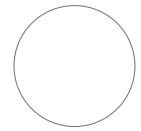

piese speciale | special pieces

**treaptă** / step tile | **TCPSE...** | 298×598×10 mm | 

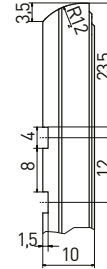
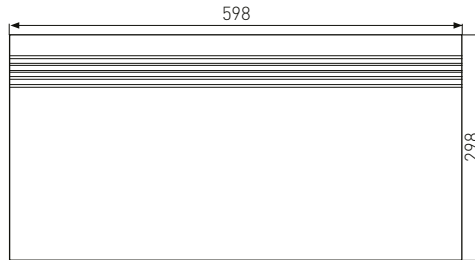

**treaptă** / step tile | **TCP34...** | 298×298×8 mm | 

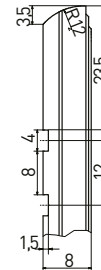
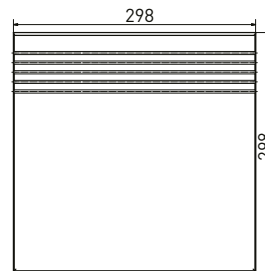

**plintă** / skirting plinth | **TSASZ...** | 598×95×10 mm | 

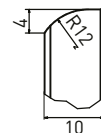
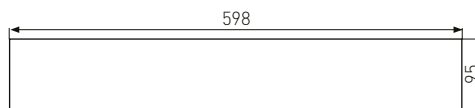



plintă / skirting plinth | **TSAKF...** | 298x80x8 mm |

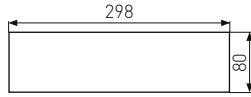

plintă cove / cove skirting | **TSPKF...** | 298x80x8 mm |

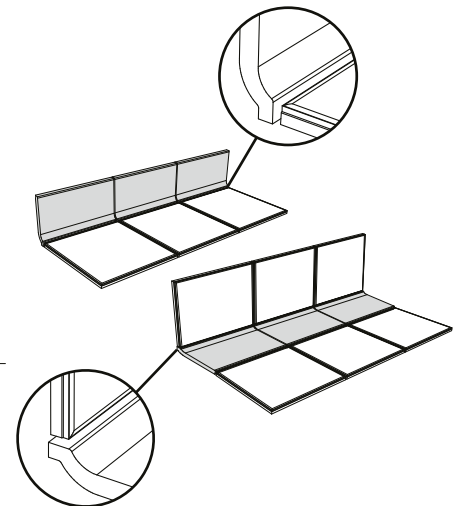
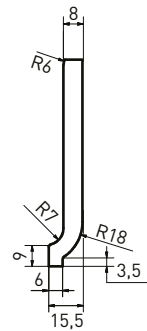
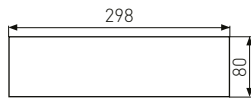

plintă cove / cove skirting | **TSPF6...** | 198x80x8 mm |

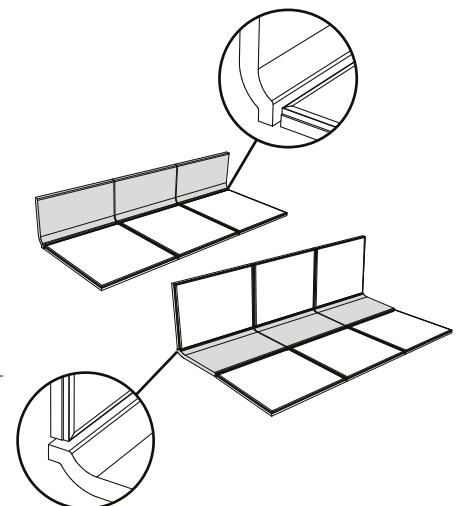
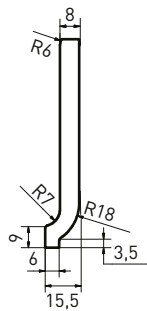
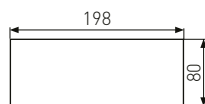

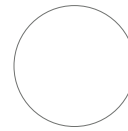

## piese speciale / special pieces

**colț interior plintă cove** / inside corner cove skirting | **TSIRH...** | 80×23×10 mm

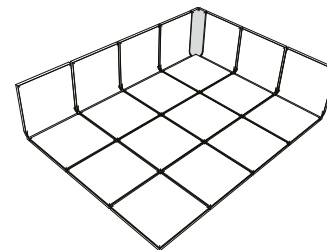
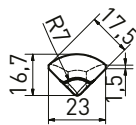
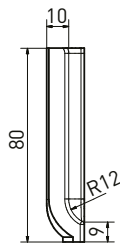

**colț exterior plintă cove** / outside corner cove skirting | **TSERH...** | 80×23×7 mm

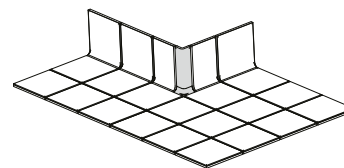
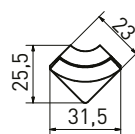
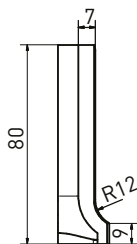

**piesă colț de duș cu pantă** / shower piece - corner | **TTR11...** | 98×98×8 mm | 

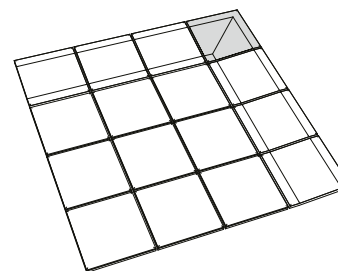
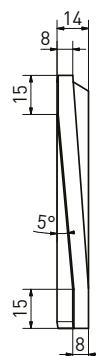
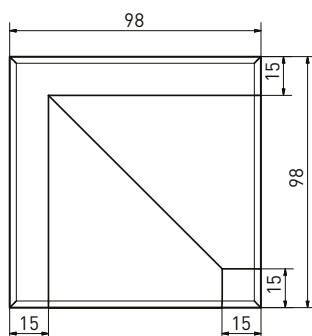





piesă de duș cu pantă / shower piece - continuous | TTP11... | 98x98x8 mm | 

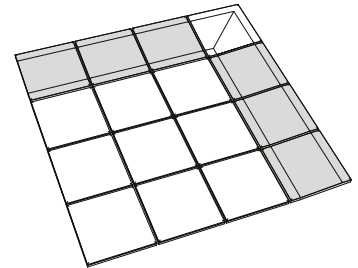
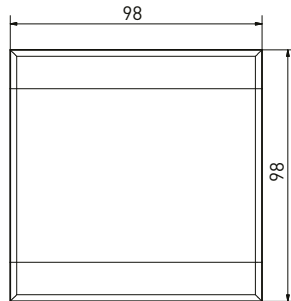

# taurus color

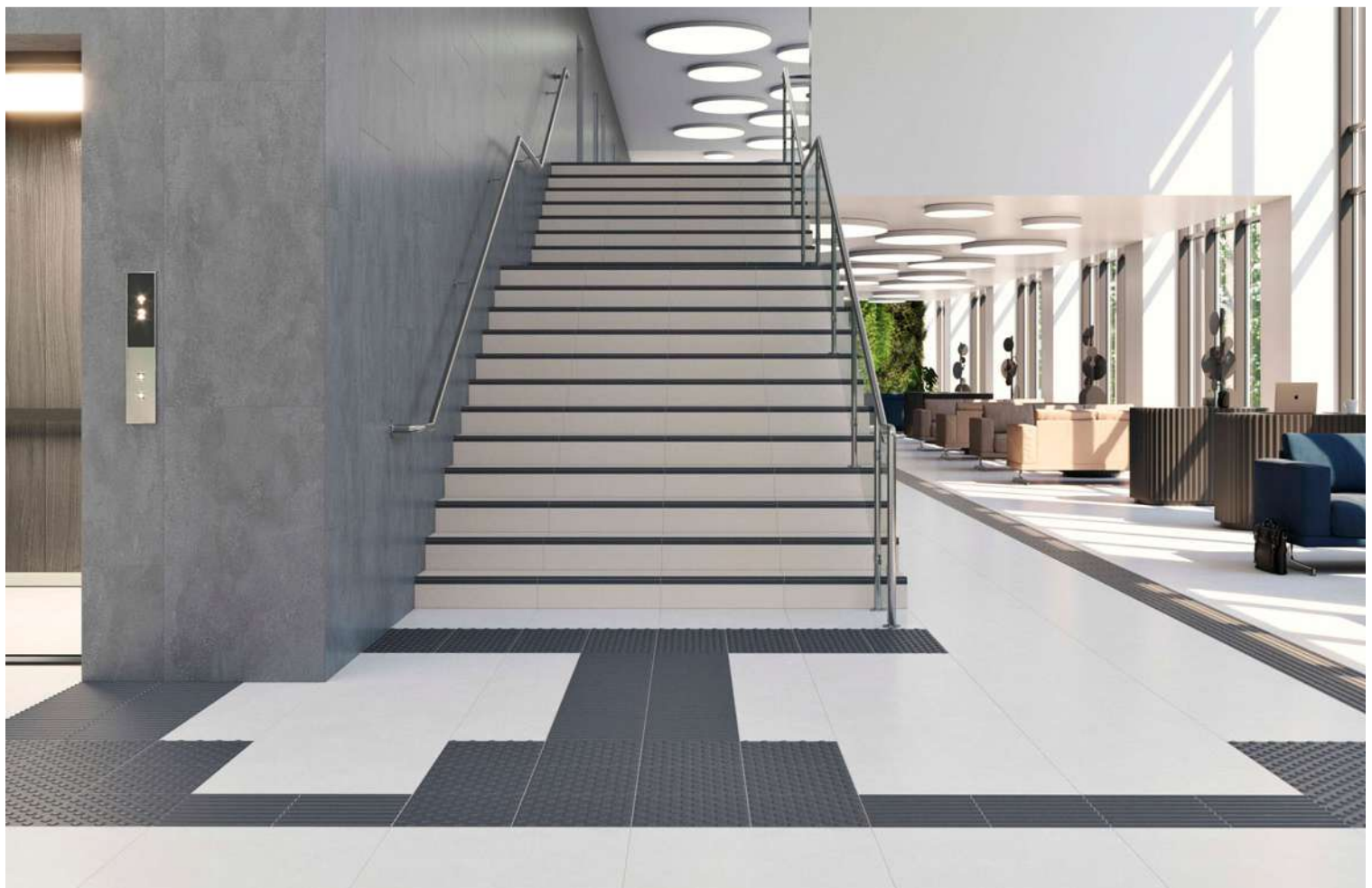
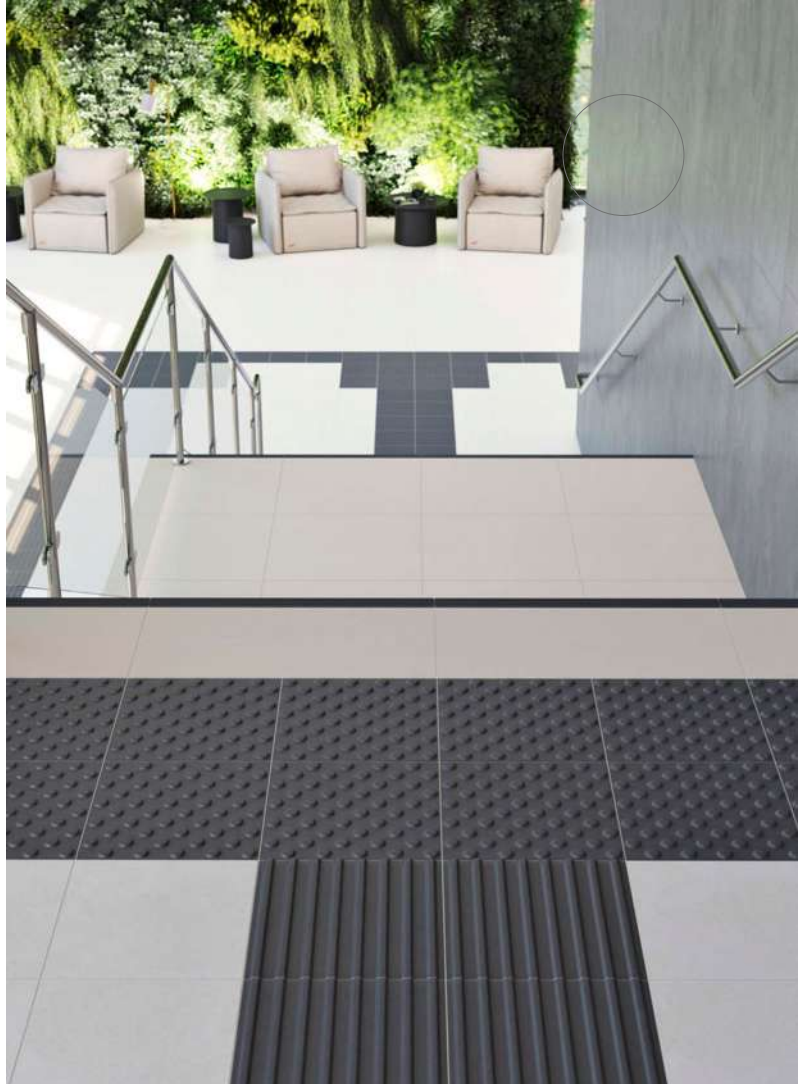



piese speciale / special pieces

treaptă cu înălțător / step piece with riser | TCPVN... | 598x50x10 mm | 598x20x10 mm |

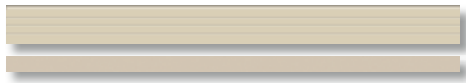

TCPVN010



TCPVN019

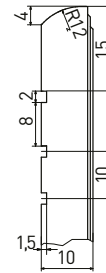
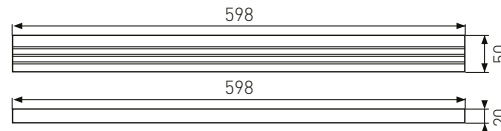
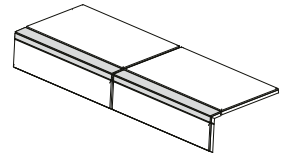

plăci ceramice in relief pentru persoanele cu deficiențe de vedere / special ceramic shaped tiles for the visually impaired persons

relief go



TTG35010

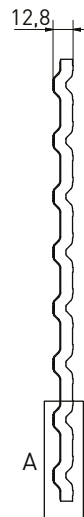

TTG35019

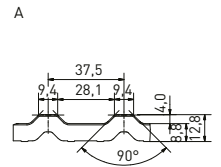

relief stop

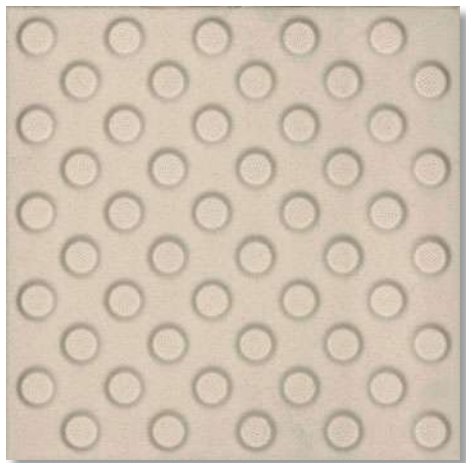

TTS35010  
ivoriu | ivory

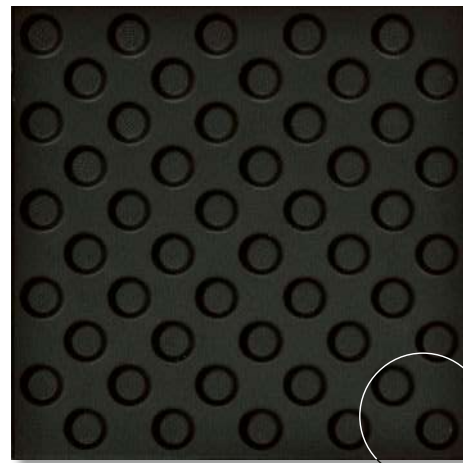
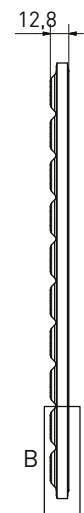

TTS35019  
negru | black

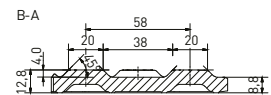
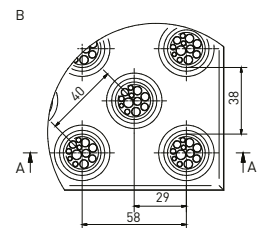



The colour spectrum of the twelve intense and twelve neutral colours of the ColorONE series is perfectly matched in colour and format to the ColorTWO glazed tiles.

The glossy and matt surface of the wall tiles is represented in a wide range of modular formats. The wall tiles allow designers and architects to create interiors with their own signature.

„Endless creativity.“





Spectrul cromatic al celor douăsprezece culori intense și al celor douăsprezece culori neutre din colecția ColorONE se potrivește perfect cu formatul lucios din colecția ColorTWO.

Suprafețele mate și lucioase ale acestor plăci de faianță sunt reprezentate într-o gamă largă de formate modulare. Aceste plăci de faianță permit designerilor și arhitecților să creeze interioare prin care să-și lase amprenta personală.

„Creativitate fără limite.“



produs / product

EN 14411 - L BIII

faianță rectificată /  
rectified wall tile

faianță rectificată /  
rectified wall tile



40×120

30×90



398×1198×10

298×898×10

suprafață / surface

mat | matt

lucios | glossy

mat | matt

lucios | glossy

mat | matt  
relief  
lamelar | lamella

lucios | glossy  
relief  
lamelar | lamella

mat | matt  
relief  
penta

lucios | glossy  
relief  
penta

culoare / color

**RAL 0001500**  
negru / black

**RAL 0004000**  
antracit gri /  
anthracite grey

**RAL 0805005**  
gri închis /  
dark grey

**RAL 0607005**  
gri / grey

**RAL 0008500**  
gri deschis /  
light grey

**WHITE**  
alb / white

**RAL 0709010**  
bej deschis |  
light beige

**RAL 0508010**  
bej / beige

**RAL 0607020**  
bej închis /  
dark beige

**RAL 0607010**  
bej-gri /  
beige-grey

**RAL 0805010**  
gri /  
grey-beige

**RAL 0502010**  
maro închis  
dark brown

WAKV5110  
○ 84 | m<sup>2</sup>

WAKV5010  
○ 84 | m<sup>2</sup>

WAKV5112  
○ 84 | m<sup>2</sup>

WAKV5012  
○ 84 | m<sup>2</sup>

WAKV6104  
○ 84 | m<sup>2</sup>

WAKV6000  
○ 84 | m<sup>2</sup>

WAKV5104  
○ 84 | m<sup>2</sup>

WAKV5000  
○ 84 | m<sup>2</sup>

WR1V5104  
○ 92 | m<sup>2</sup>

WR1V5000  
○ 92 | m<sup>2</sup>

WR2V5104  
○ 92 | m<sup>2</sup>

WR2V5000  
○ 92 | m<sup>2</sup>

WAKV5107  
○ 84 | m<sup>2</sup>

WAKV5007  
○ 84 | m<sup>2</sup>

WAKV5108  
○ 84 | m<sup>2</sup>

WAKV5008  
○ 84 | m<sup>2</sup>

informații logistice / logistic information



3

4



2,1

3,7



1,44

1,08



21

30



30,24

32,40



29

20



20,1

18,5

404



633

625



produs / product



EN 14411 - L BIII

faianță /  
wall tile

faianță /  
wall tile



30×60

20×60



298×598×8

198×598×10

suprafață / surface

mat | matt

lucios | glossy

mat | matt  
relief  
ondulat | wave

lucios | glossy  
relief  
ondulat | wave

mat | matt  
relief  
stropit | spattle

lesk | glossy  
relief  
stropit | spattle

mat | matt

lucios | glossy

culoare / color

**RAL 0001500**  
negru / black

**RAL 0004000**  
antracit gri /  
anthracite grey

**RAL 0805005**  
gri închis /  
dark grey

**RAL 0607005**  
gri / grey

**RAL 0008500**  
gri deschis /  
light grey

**WHITE**  
alb / white

**RAL 0709010**  
bej deschis /  
light beige

**RAL 0508010**  
bej / beige

**RAL 0607020**  
bej închis /  
dark beige

**RAL 0607010**  
bej-gri /  
beige-grey

**RAL 0805010**  
gri /  
grey-beige

**RAL 0502010**  
maro închis /  
dark brown

WAAVK110  
○ 78 | m<sup>2</sup>

WAAVK010  
○ 78 | m<sup>2</sup>

WAAVE110  
○ 78 | m<sup>2</sup>

WAAVE010  
○ 78 | m<sup>2</sup>

WAAVK112  
○ 78 | m<sup>2</sup>

WAAVK012  
○ 78 | m<sup>2</sup>

WAAVE112  
○ 78 | m<sup>2</sup>

WAAVE012  
○ 78 | m<sup>2</sup>

WAAVK104  
○ 74 | m<sup>2</sup>

WAAVK000  
○ 74 | m<sup>2</sup>

WARVK104  
○ 74 | m<sup>2</sup>

WARVK000  
○ 74 | m<sup>2</sup>

WAGVK104  
○ 74 | m<sup>2</sup>

WAGVK000  
○ 74 | m<sup>2</sup>

WAAVE104  
○ 74 | m<sup>2</sup>

WAAVE000  
○ 74 | m<sup>2</sup>

WAAVK107  
○ 78 | m<sup>2</sup>

WAAVK007  
○ 78 | m<sup>2</sup>

WAAVE107  
○ 78 | m<sup>2</sup>

WAAVE007  
○ 78 | m<sup>2</sup>

WAAVK108  
○ 78 | m<sup>2</sup>

WAAVK008  
○ 78 | m<sup>2</sup>

WAAVE108  
○ 78 | m<sup>2</sup>

WAAVE008  
○ 78 | m<sup>2</sup>

informații logistice / logistic information



8

9



5,56

8,3



1,44

1,08



40

42



57,6

45,36



21,3

20,0



14,8

18,5

406

brutto kg















876

865





 <b>faiantă /</b> wall tile		 <b>faiantă /</b> wall tile			
<b>20×40</b>		<b>25×33</b>			
198×398×7		250×330×7			
mat   matt	lucios   glossy	mat   matt	lucios   glossy	mat   matt relief ondulat   wave	lucios   glossy relief ondulat   wave
WAAMB732 ○ 76   m <sup>2</sup>	WAAMB779 ○ 76   m <sup>2</sup>				
WAAMB765 ○ 76   m <sup>2</sup>	WAAMB755 ○ 76   m <sup>2</sup>				
WAAMB111 ○ 74   m <sup>2</sup>	WAAMB011 ○ 74   m <sup>2</sup>	WAAKB111 ○ 70   m <sup>2</sup>	WAAKB011 ○ 70   m <sup>2</sup>		
WAAMB110 ○ 74   m <sup>2</sup>	WAAMB010 ○ 74   m <sup>2</sup>	WAAKB110 ○ 70   m <sup>2</sup>	WAAKB010 ○ 70   m <sup>2</sup>		
WAAMB112 ○ 74   m <sup>2</sup>	WAAMB012 ○ 74   m <sup>2</sup>	WAAKB112 ○ 70   m <sup>2</sup>	WAAKB012 ○ 70   m <sup>2</sup>		
WAAMB104 ○ 72   m <sup>2</sup>	WAAMB000 ○ 72   m <sup>2</sup>	WAAKB104 ○ 66   m <sup>2</sup>	WAAKB000 ○ 66   m <sup>2</sup>	WARKB104 ○ 66   m <sup>2</sup>	WARKB000 ○ 66   m <sup>2</sup>
WAAMB107 ○ 74   m <sup>2</sup>	WAAMB007 ○ 74   m <sup>2</sup>	WAAKB107 ○ 70   m <sup>2</sup>	WAAKB007 ○ 70   m <sup>2</sup>		
WAAMB108 ○ 74   m <sup>2</sup>	WAAMB008 ○ 74   m <sup>2</sup>	WAAKB108 ○ 70   m <sup>2</sup>	WAAKB008 ○ 70   m <sup>2</sup>		
WAAMB311 ○ 74   m <sup>2</sup>	WAAMB301 ○ 74   m <sup>2</sup>				
WAAMB312 ○ 74   m <sup>2</sup>	WAAMB302 ○ 74   m <sup>2</sup>				
WAAMB313 ○ 76   m <sup>2</sup>	WAAMB303 ○ 76   m <sup>2</sup>				
WAAMB681 ○ 76   m <sup>2</sup>	WAAMB671 ○ 76   m <sup>2</sup>				
20		18		18	
12,5		12,0		12,0	
1,60		1,50		1,50	
48		54		54	
76,80		81,00		81,00	
20,6		18,6		18,6	
12,9		12,4		12,4	
1 016		1 030		1 030	

produs / product												
EN 14411 - L BIII	faianță / wall tile				faianță / wall tile							
	20×25				20×20				15×20			
	198×248×6,8				198×198×6,5				148×198×6			
suprafață / surface	mat   matt	lucios   glossy	mat   matt relief ondulat   wave	lucios   glossy relief ondulat   wave	mat   matt	lucios   glossy	mat   matt	lucios   glossy				
culoare / color												
<b>RAL 0001500</b> negru / black					WAA1N732 ○ 74   m <sup>2</sup>	WAA1N779 ○ 74   m <sup>2</sup>						
<b>RAL 0004000</b> antracit gri / anthracite grey					WAA1N765 ○ 74   m <sup>2</sup>	WAA1N755 ○ 74   m <sup>2</sup>						
<b>RAL 0805005</b> gri închis / dark grey					WAA1N111 ○ 70   m <sup>2</sup>	WAA1N011 ○ 70   m <sup>2</sup>						
<b>RAL 0607005</b> gri / grey					WAA1N210 ○ 70   m <sup>2</sup>	WAA1N010 ○ 70   m <sup>2</sup>						
<b>RAL 0008500</b> gri deschis / light grey					WAA1N112 ○ 70   m <sup>2</sup>	WAA1N012 ○ 70   m <sup>2</sup>						
<b>WHITE</b> alb / white	WAAG6104 ○ 66   m <sup>2</sup>	WAAG6000 ○ 66   m <sup>2</sup>	WARG6104 ○ 68   m <sup>2</sup>	WARG6000 ○ 68   m <sup>2</sup>	WAA1N104 ○ 66   m <sup>2</sup>	WAA1N000 ○ 66   m <sup>2</sup>	WAADP104 ○ 72   m <sup>2</sup>	WAADP000 ○ 72   m <sup>2</sup>				
<b>RAL 0709010</b> bej deschis / light beige					WAA1N107 ○ 70   m <sup>2</sup>	WAA1N007 ○ 70   m <sup>2</sup>						
<b>RAL 0508010</b> bej / beige					WAA1N108 ○ 70   m <sup>2</sup>	WAA1N008 ○ 70   m <sup>2</sup>						
<b>RAL 0607020</b> bej închis / dark beige					WAA1N311 ○ 70   m <sup>2</sup>	WAA1N301 ○ 70   m <sup>2</sup>						
<b>RAL 0607010</b> bej-gri / beige-grey					WAA1N312 ○ 70   m <sup>2</sup>	WAA1N302 ○ 70   m <sup>2</sup>						
<b>RAL 0805010</b> grej / grey-beige					WAA1N313 ○ 74   m <sup>2</sup>	WAA1N303 ○ 74   m <sup>2</sup>						
<b>RAL 0502010</b> maro închis / dark brown					WAA1N681 ○ 74   m <sup>2</sup>	WAA1N671 ○ 74   m <sup>2</sup>						
informații logistice / logistic information												
					30	25	33					
					20,0	25,0	33,0					
					1,50	1,00	1,00					
					60	84	100					
					90,00	84,00	100,00					
					17,6	11,2	10,2					
					11,7	11,2	10,2					
408 					1 078	966	1 045					



faianță /  
wall tile

faianță portelanată /  
wall tile overglazed edge

15×15

148×148×6

mat   matt	lucios   glossy	mat   matt	lucios   glossy
WAA19732 ○ 74   m <sup>2</sup>	WAA19779 ○ 74   m <sup>2</sup>		
WAA19765 ○ 74   m <sup>2</sup>	WAA19755 ○ 74   m <sup>2</sup>		
WAA19111 ○ 70   m <sup>2</sup>	WAA19011 ○ 70   m <sup>2</sup>		
WAA19210 ○ 70   m <sup>2</sup>	WAA19010 ○ 70   m <sup>2</sup>		
WAA19112 ○ 70   m <sup>2</sup>	WAA19012 ○ 70   m <sup>2</sup>		
WAA19104 ○ 66   m <sup>2</sup>	WAA19000 ○ 66   m <sup>2</sup>	WAE19104 ○ 68   m <sup>2</sup>	WAE19000 ○ 68   m <sup>2</sup> ⓘ
WAA19107 ○ 70   m <sup>2</sup>	WAA19007 ○ 70   m <sup>2</sup>		
WAA19108 ○ 70   m <sup>2</sup>	WAA19008 ○ 70   m <sup>2</sup>		
WAA19311 ○ 70   m <sup>2</sup>	WAA19301 ○ 70   m <sup>2</sup>		
WAA19312 ○ 70   m <sup>2</sup>	WAA19302 ○ 70   m <sup>2</sup>		
WAA19313 ○ 74   m <sup>2</sup>	WAA19303 ○ 74   m <sup>2</sup>		
WAA19681 ○ 74   m <sup>2</sup>	WAA19671 ○ 74   m <sup>2</sup>		

44

44,0

1,00

100

100,00

10,0

10,0

1 025





produs / product						
EN 14411 - L BIII	faianță / wall tile		faianță / wall tile		faianță / wall tile	
	20×40		20×20		15×15	
	198×398×7		198×198×6,5		148×148×6	
suprafață / surface	mat   matt	lucios   glossy	mat   matt	lucios   glossy	mat   matt	lucios   glossy
culoare / color						
<b>RAL 0304060</b> roșu / red	WAAMB373 ○ 82   m <sup>2</sup>	WAAMB363 ○ 82   m <sup>2</sup>	WAA1N373 ○ 76   m <sup>2</sup>	WAA1N363 ○ 76   m <sup>2</sup>	WAA19373 ○ 78   m <sup>2</sup>	WAA19363 ○ 78   m <sup>2</sup>
<b>RAL 0506080</b> orange / orange	WAAMB460 ○ 82   m <sup>2</sup>	WAAMB450 ○ 82   m <sup>2</sup>	WAA1N460 ○ 76   m <sup>2</sup>	WAA1N450 ○ 76   m <sup>2</sup>	WAA19460 ○ 78   m <sup>2</sup>	WAA19450 ○ 78   m <sup>2</sup>
<b>RAL 0607050</b> orange deschis / light orange	WAAMB282 ○ 76   m <sup>2</sup>	WAAMB272 ○ 76   m <sup>2</sup>	WAA1N282 ○ 74   m <sup>2</sup>	WAA1N272 ○ 74   m <sup>2</sup>	WAA19282 ○ 74   m <sup>2</sup>	WAA19272 ○ 74   m <sup>2</sup>
<b>RAL 0858070</b> galben închis / dark yellow	WAAMB222 ○ 76   m <sup>2</sup>	WAAMB201 ○ 76   m <sup>2</sup>	WAA1N222 ○ 74   m <sup>2</sup>	WAA1N201 ○ 74   m <sup>2</sup>	WAA19222 ○ 74   m <sup>2</sup>	WAA19201 ○ 74   m <sup>2</sup>
<b>RAL 0908040</b> galben / yellow	WAAMB221 ○ 74   m <sup>2</sup>	WAAMB200 ○ 74   m <sup>2</sup>	WAA1N221 ○ 70   m <sup>2</sup>	WAA1N200 ○ 70   m <sup>2</sup>	WAA19221 ○ 70   m <sup>2</sup>	WAA19200 ○ 70   m <sup>2</sup>
<b>RAL 0958070</b> galben-verde / yellow-green	WAAMB464 ○ 74   m <sup>2</sup>	WAAMB454 ○ 74   m <sup>2</sup>	WAA1N464 ○ 70   m <sup>2</sup>	WAA1N454 ○ 70   m <sup>2</sup>	WAA19464 ○ 70   m <sup>2</sup>	WAA19454 ○ 70   m <sup>2</sup>
<b>RAL 1208050</b> verde deschis / light green	WAAMB465 ○ 74   m <sup>2</sup>	WAAMB455 ○ 74   m <sup>2</sup>	WAA1N465 ○ 70   m <sup>2</sup>	WAA1N455 ○ 70   m <sup>2</sup>	WAA19465 ○ 70   m <sup>2</sup>	WAA19455 ○ 70   m <sup>2</sup>
<b>RAL 1306050</b> verde / green	WAAMB466 ○ 74   m <sup>2</sup>	WAAMB456 ○ 74   m <sup>2</sup>	WAA1N466 ○ 70   m <sup>2</sup>	WAA1N456 ○ 70   m <sup>2</sup>	WAA19466 ○ 70   m <sup>2</sup>	WAA19456 ○ 70   m <sup>2</sup>
<b>RAL 1907025</b> turcoaz / turquoise	WAAMB467 ○ 74   m <sup>2</sup>	WAAMB457 ○ 74   m <sup>2</sup>	WAA1N467 ○ 70   m <sup>2</sup>	WAA1N457 ○ 70   m <sup>2</sup>	WAA19467 ○ 70   m <sup>2</sup>	WAA19457 ○ 70   m <sup>2</sup>
<b>RAL 2408015</b> albastru deschis / light blue	WAAMB540 ○ 74   m <sup>2</sup>	WAAMB550 ○ 74   m <sup>2</sup>	WAA1N540 ○ 70   m <sup>2</sup>	WAA1N550 ○ 70   m <sup>2</sup>	WAA19540 ○ 70   m <sup>2</sup>	WAA19550 ○ 70   m <sup>2</sup>
<b>RAL 2606025</b> albastru / blue	WAAMB541 ○ 74   m <sup>2</sup>	WAAMB551 ○ 74   m <sup>2</sup>	WAA1N541 ○ 70   m <sup>2</sup>	WAA1N551 ○ 70   m <sup>2</sup>	WAA19541 ○ 70   m <sup>2</sup>	WAA19551 ○ 70   m <sup>2</sup>
<b>RAL 2902035</b> albastru închis / dark blue	WAAMB545 ○ 76   m <sup>2</sup>	WAAMB555 ○ 76   m <sup>2</sup>	WAA1N545 ○ 74   m <sup>2</sup>	WAA1N555 ○ 74   m <sup>2</sup>	WAA19545 ○ 74   m <sup>2</sup>	WAA19555 ○ 74   m <sup>2</sup>
informații logistice / logistic information						
	20		25		44	
	12,5		25,0		44,0	
	1,60		1,00		1,00	
	48		84		100	
	76,80		84,00		100,00	
	20,6		11,2		10,0	
	12,9		11,2		10,0	
	1 016		966		1 025	

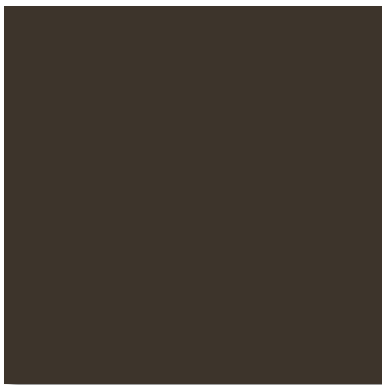

**RAL 0001500**  
negru / black



**RAL 0004000**  
antracit gri / anthracite grey

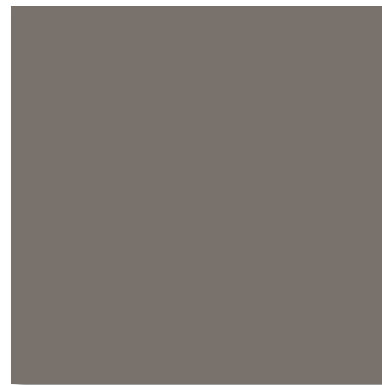

**RAL 0805005**  
gri închis / dark grey

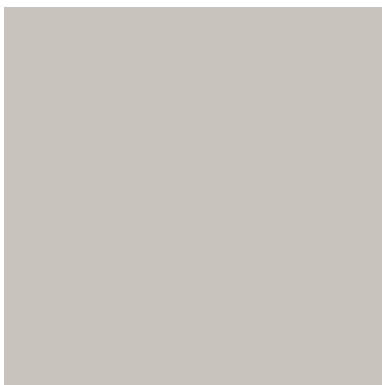

**RAL 0607005**  
gri / grey

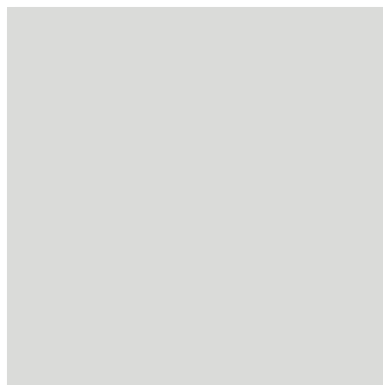

**RAL 0008500**  
gri deschis / light grey



**WHITE**  
alb / white

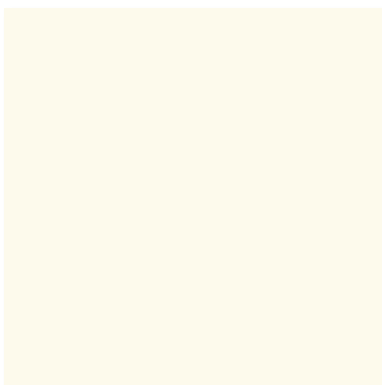

**RAL 0709010**  
bej deschis / light beige



**RAL 0508010**  
bej / beige



**RAL 0607020**  
bej închis / dark beige



**RAL 0607010**  
bej-gri / beige-grey



**RAL 0805010**  
gri / grey-beige



**RAL 0502010**  
maro închis / dark brown

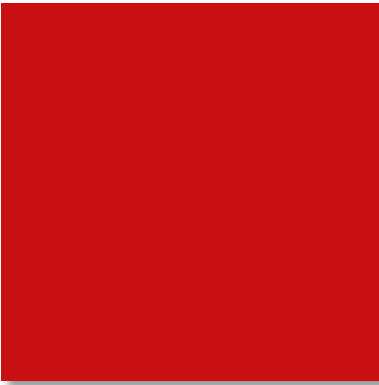

**RAL 0304060**  
roșu / red



**RAL 0506080**  
orange / orange



**RAL 0607050**  
orange deschis / light orange



**RAL 0858070**  
galben închis / dark yellow



**RAL 0908040**  
galben / yellow



**RAL 0958070**  
galben-verde / yellow-green



**RAL 1208050**  
verde deschis / light green



**RAL 1306050**  
verde / green



**RAL 1907025**  
turcoaz / turquoise

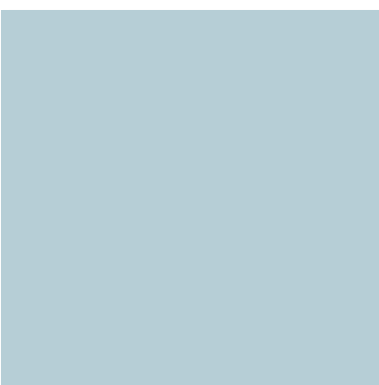

**RAL 2408015**  
albastru deschis / light blue



**RAL 2606025**  
albastru / blue



**RAL 2902035**  
albastru închis / dark blue







mat / matt

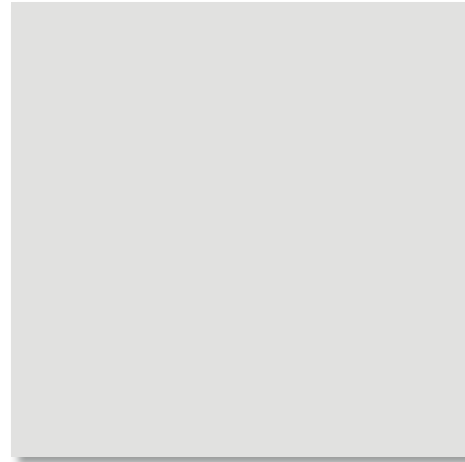

lucios / glossy



relief  
ondulat / wave



relief  
punctat / spattle

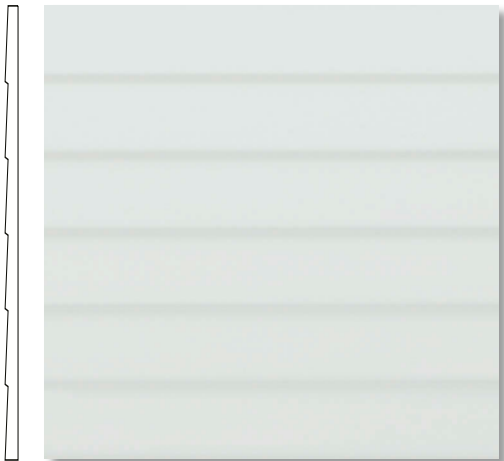

relief  
lamelar / lamella



relief  
poligon / penta



A comprehensive series of sintered glazed tiles ColorTWO systemically linked to the ColorONE colour spectrum invites you to overall project solutions and unconventional applications.

The modular formats and a wide range of functional supplies allow different basic elements to be combined with each other and to achieve optimum compatibility with the ColorONE wall tile series.

„Unique color combinations.“



















O serie cuprinzătoare de plăci de faianță vitrificată sinterizată Color-TWO, legată sistematic de spectrul cromatic ColorONE, vă invită la soluții complete pentru proiecte și aplicații neconvenționale.













Formatele modulare și o gamă largă de accesorii funcționale permit combinarea diferitelor elemente de bază între ele și obținerea unei compatibilități optime cu seria de plăci de perete ColorONE.

„Combi-nații unice de culori.”















produs / product									
EN 14411 - G B1a	gresie / floor tile	gresie / floor tile	gresie / floor tile			gresie / floor tile			gresie / floor tile
	30×60 	30×30	20×20			10×30		10×20	
	298×598×10	298×298×8	198×198×7			98×298×8			98×198×7
suprafață / surface	mat   matt ABS	mat   matt	mat   matt	mat   matt GAF	mat   matt relief GRS	mat   matt	lucios   glossy	mat   matt	mat   matt relief GRN
rezistentă la alunecare slip resistance	R10/B			R10/B	R10/B				R10/B
coeficient de frecare la alunecare sliding friction coefficient	$\mu \geq 0,6$	$\mu \geq 0,5$	$\mu \geq 0,5$	$\mu \geq 0,6$	$\mu \geq 0,6$	$\mu \geq 0,5$		$\mu \geq 0,5$	$\mu \geq 0,6$
barva / color									
<b>RAL 0001500</b> negru / black			GAA1K048 ○ 80   m <sup>2</sup>						
<b>RAL 0004000</b> antracit gri / anthracite grey			GAA1K248 ○ 80   m <sup>2</sup>	GAF1K248 ○ 82   m <sup>2</sup>	GRS1K248 ○ 82   m <sup>2</sup>	GAAJD248 ○ 82   m <sup>2</sup>			
<b>RAL 0805005</b> gri deschis / dark grey			GAA1K111 ○ 80   m <sup>2</sup>						
<b>RAL 0607005</b> gri / grey			GAA1K110 ○ 76   m <sup>2</sup>	GAF1K610 ○ 78   m <sup>2</sup>	GRS1K610 ○ 78   m <sup>2</sup>	GAAJD110 ○ 82   m <sup>2</sup>		GAAD8110 ○ 82   m <sup>2</sup>	
<b>RAL 0008500</b> gri deschis / light grey			GAA1K112 ○ 76   m <sup>2</sup>	GAF1K612 ○ 78   m <sup>2</sup>	GRS1K612 ○ 78   m <sup>2</sup>	GAAJD112 ○ 82   m <sup>2</sup>			
<b>WHITE</b> alb / white	GAKSE023 ○ 84   m <sup>2</sup>	GAA2J023 ○ 76   m <sup>2</sup>	GAA1K023 ○ 74   m <sup>2</sup>	GAF1K023 ○ 76   m <sup>2</sup>	GRS1K623 ○ 76   m <sup>2</sup>	GAAJD023 ○ 82   m <sup>2</sup>	GAAJD052 ○ 82   m <sup>2</sup>	GAAD8023 ○ 80   m <sup>2</sup>	GRND8023 ○ 82   m <sup>2</sup>
<b>RAL 0709010</b> bej deschis / light beige			GAA1K107 ○ 76   m <sup>2</sup>		GRS1K607 ○ 78   m <sup>2</sup>	GAAJD107 ○ 82   m <sup>2</sup>			
<b>RAL 0508010</b> bej / beige			GAA1K108 ○ 76   m <sup>2</sup>		GRS1K608 ○ 78   m <sup>2</sup>	GAAJD108 ○ 82   m <sup>2</sup>		GAAD8108 ○ 82   m <sup>2</sup>	
<b>RAL 0607020</b> bej închis / dark beige			GAA1K311 ○ 80   m <sup>2</sup>						
<b>RAL 0607010</b> bej gri / beige-grey			GAA1K312 ○ 80   m <sup>2</sup>						
<b>RAL 0805010</b> grej / grey-beige			GAA1K313 ○ 82   m <sup>2</sup>						
<b>RAL 0502010</b> maro închis / dark brown			GAA1K671 ○ 82   m <sup>2</sup>						
<b>informații logistice</b>   logistic information									
	6	13		25		24		35	
	5,6	11,0		25,0		33,3		50,0	
	1,08	1,18		1,00		0,72		0,70	
	40	48		72		66		90	
	43,2	56,64		72,00		47,52		63,00	
	23,7	20,5		15,5		12,5		10,5	
	21,9	17,4		15,5		17,3		15,0	
418 	971	1 011		1 141		851		971	







produs / product			 				
EN 14411 - G Bla	gresie / floor tile	gresie / floor tile	gresie / floor tile				
	20×20	10×20	10×10				
 mm	198×198×7	98×198×7	98×98×6				
suprafață / surface	mat   matt	mat   matt relief GRS	mat   matt relief GRN	mat   matt	lucios   glossy	mat   matt relief GRS	mat   matt relief GRH
rezistență la alunecare slip resistance		R10/B	R10/B			R10/B	↗C
coeficient frecare la alunecare sliding friction coefficient	μ ≥ 0,5	μ ≥ 0,6	μ ≥ 0,5	μ ≥ 0,6	μ ≥ 0,5	μ ≥ 0,6	μ ≥ 0,7
culoare / color							
<b>RAL 0304060</b> roșu / red	GAA1K459 ○ 88   m <sup>2</sup>				GAA0K459 ○ 102   m <sup>2</sup>	GAA0K359 ○ 102   m <sup>2</sup>	
<b>RAL 0506080</b> orange / orange	GAA1K460 ○ 84   m <sup>2</sup>						
<b>RAL 0607050</b> orange deschis / light orange	GAA1K150 ○ 80   m <sup>2</sup>		GAAD8150 ○ 86   m <sup>2</sup>		GAA0K150 ○ 90   m <sup>2</sup>		GRS0K650 ○ 92   m <sup>2</sup>
<b>RAL 0858070</b> galben închis / dark yellow	GAA1K142 ○ 80   m <sup>2</sup>		GAAD8142 ○ 86   m <sup>2</sup>		GAA0K142 ○ 90   m <sup>2</sup>		GRS0K642 ○ 92   m <sup>2</sup>
<b>RAL 0908040</b> galben / yellow	GAA1K124 ○ 78   m <sup>2</sup>						
<b>RAL 0958070</b> galben-verde / yellow-green	GAA1K464 ○ 80   m <sup>2</sup>						
<b>RAL 1208050</b> verde deschis / light green	GAA1K465 ○ 78   m <sup>2</sup>						
<b>RAL 1306050</b> verde / green	GAA1K466 ○ 80   m <sup>2</sup>				GAA0K466 ○ 88   m <sup>2</sup>		
<b>RAL 1907025</b> turquoise / turquoise	GAA1K467 ○ 80   m <sup>2</sup>		GAAD8467 ○ 86   m <sup>2</sup>		GAA0K467 ○ 88   m <sup>2</sup>		GRS0K667 ○ 90   m <sup>2</sup>
<b>RAL 2408015</b> albastru deschis / light blue	GAA1K003 ○ 76   m <sup>2</sup>	GRS1K603 ○ 78   m <sup>2</sup>	GAAD8003 ○ 82   m <sup>2</sup>	GRND8003 ○ 84   m <sup>2</sup>	GAA0K003 ○ 86   m <sup>2</sup>		GRS0K603 ○ 88   m <sup>2</sup> GRH0K263 ○ 88   m <sup>2</sup>
<b>RAL 2606025</b> albastru / blue	GAA1K127 ○ 78   m <sup>2</sup>						
<b>RAL 2902035</b> albastru închis / dark blue	GAA1K555 ○ 80   m <sup>2</sup>	GRS1K605 ○ 82   m <sup>2</sup>	GAAD8005 ○ 86   m <sup>2</sup>	GRND8005 ○ 88   m <sup>2</sup>	GAA0K555 ○ 92   m <sup>2</sup>		GRS0K605 ○ 94   m <sup>2</sup> GRH0K205 ○ 92   m <sup>2</sup>
informații logistice / logistic information							
	25		35			11	
	25,0		50,0			11,0	
	1,00		0,70			1,00	
	72		90			60	
	72,00		63,00			60,00	
	15,5		10,5			12,9	
	15,5		15,0			12,9	
420 	1 141		971			799	



produs / product					
STO č. 030 - 059824	<b>plintă cove /</b> cove skirting	<b>plintă cove /</b> cove skirting	<b>colț interior plintă</b> <b>cove /</b> inside corner cove skirting	<b>colț exterior plintă</b> <b>cove /</b> outside corner cove skirting	<b>colț interior plintă /</b> inside edge
	<b>20×20</b>	<b>20×20</b>	<b>2,4×20</b>	<b>3×20</b>	<b>2,4×20</b>
	204×198×7	204×198×7	204×24×7	204×30×7	198×24×7
suprafață / surface	mat   matt relief GRS	mat   matt	mat   matt	mat   matt	mat   matt GAF
rezistență la alunecare slip resistance	R10/B				R10/B
coeficient de frecare la alunecare sliding friction coefficient	$\mu \geq 0,6$				$\mu \geq 0,6$
culoare / color					
<b>RAL 0004000</b> antracit gri / anthracite grey	GST1K248 ○ 46   ks	GSP1K248 ○ 40   ks	GSIRI248 ○ 52   ks	GSEIRI248 ○ 52   ks	GSIAP248 ○ 52   ks
<b>RAL 0607005</b> gri / grey	GST1K110 ○ 46   ks	GSP1K110 ○ 40   ks	GSIRI110 ○ 52   ks	GSEIRI110 ○ 52   ks	GSIAP110 ○ 52   ks
<b>RAL 0008500</b> gri deschis / light grey	GST1K112 ○ 46   ks	GSP1K112 ○ 40   ks	GSIRI112 ○ 52   ks	GSEIRI112 ○ 52   ks	GSIAP112 ○ 52   ks
<b>WHITE</b> alb / white	GST1K023 ○ 46   ks	GSP1K023 ○ 40   ks	GSIRI023 ○ 52   ks	GSEIRI023 ○ 52   ks	GSIAP023 ○ 52   ks GSIAPF23 ○ 52   ks
<b>RAL 0709010</b> bej deschis / light beige	GST1K107 ○ 46   ks	GSP1K107 ○ 40   ks	GSIRI107 ○ 52   ks	GSEIRI107 ○ 52   ks	GSIAP107 ○ 52   ks
<b>RAL 0508010</b> bej / beige	GST1K108 ○ 46   ks	GSP1K108 ○ 40   ks	GSIRI108 ○ 52   ks	GSEIRI108 ○ 52   ks	GSIAP108 ○ 52   ks
<b>RAL 2408015</b> albastru deschis / light blue	GST1K003 ○ 46   ks	GSP1K003 ○ 40   ks	GSIRI003 ○ 52   ks	GSEIRI003 ○ 52   ks	GSIAP003 ○ 52   ks GSIAPF03 ○ 52   ks
<b>RAL 2902035</b> albastru închis / dark blue	GST1K005 ○ 46   ks	GSP1K005 ○ 40   ks	GSIRI005 ○ 52   ks	GSEIRI005 ○ 52   ks	GSIAP005 ○ 52   ks GSIAPF05 ○ 52   ks
<b>informații logistice / logistic information</b>					
	28	28	24	24	24
	-	-	-	-	-
	-	-	-	-	-
	-	-	-	-	-
	-	-	-	-	-
	17,6	17,6	3,1	3,6	3,1
	-	-	-	-	-
	-	-	-	-	-





 piesă colț exterior   outside edge		 colț exterior   outside corner		 piesă colț de duș cu pantă   shower piece corner	 piesă de duș cu pantă   shower piece continuous
2,4×20		2,4×2,4		10×10	10×10
198×24×7		24×24×24		98×98×6	98×98×6
mat   matt	mat   matt GAF	mat   matt	mat   matt GAF	mat   matt relief GRS	mat   matt relief GRS
	R10/B		R10/B	R10/B	R10/B
	μ ≥ 0,6		μ ≥ 0,6	μ ≥ 0,6	μ ≥ 0,6
GSEAP248 ○ 52   ks		GTVR4248 ○ 60   ks		GTRON248 ○ 52   ks	GTPON248 ○ 52   ks
GSEAP110 ○ 52   ks		GTVR4110 ○ 60   ks		GTRON610 ○ 52   ks	GTPON610 ○ 52   ks
GSEAP112 ○ 52   ks		GTVR4112 ○ 60   ks		GTRON612 ○ 52   ks	GTPON612 ○ 52   ks
GSEAP023 ○ 52   ks	GSEAPF23 ○ 52   ks	GTVR4023 ○ 60   ks	GTVR4F23 ○ 60   ks	GTRON623 ○ 52   ks	GTPON623 ○ 52   ks
GSEAP107 ○ 52   ks		GTVR4107 ○ 60   ks		GTRON607 ○ 52   ks	GTPON607 ○ 52   ks
GSEAP108 ○ 52   ks		GTVR4108 ○ 60   ks		GTRON608 ○ 52   ks	GTPON608 ○ 52   ks
GSEAP003 ○ 52   ks	GSEAPF03 ○ 52   ks	GTVR4003 ○ 60   ks	GTVR4F03 ○ 60   ks		
GSEAP005 ○ 52   ks	GSEAPF05 ○ 52   ks	GTVR4005 ○ 60   ks	GTVR4F05 ○ 60   ks	GTRON605 ○ 52   ks	GTPON605 ○ 52   ks
	24		50	18	18
	-		-	100,0	100,0
	-		-	0,18	0,18
	-		-	-	-
	-		-	-	-
	3,1		0,9	3,3	3,1
	-		-	-	-
	-		-	-	-



culori / colors

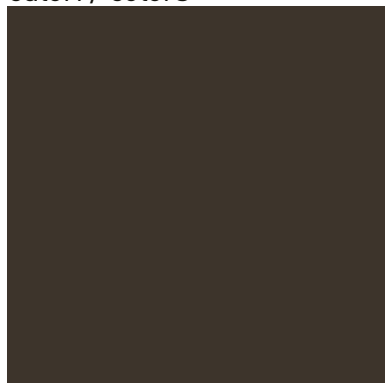

**RAL 0001500**  
negru / black

PEI 2



**RAL 0004000**  
antracit gri / anthracite grey

PEI 2

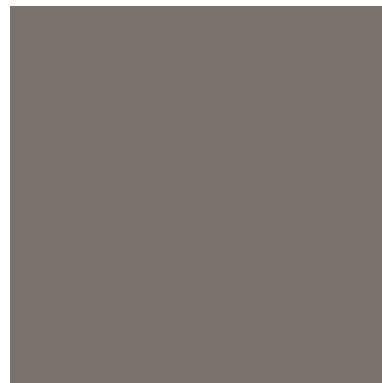

**RAL 0805005**  
gri închis / dark grey

PEI 3

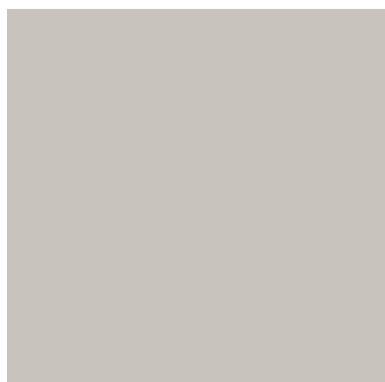

**RAL 0607005**  
gri / grey

PEI 4

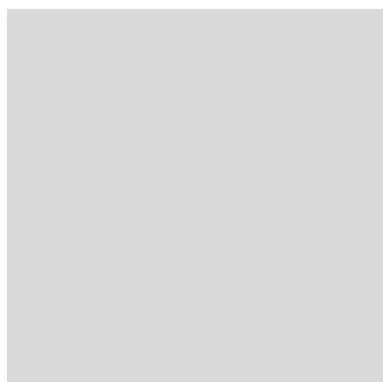

**RAL 0008500**  
gri deschis / light grey

PEI 4



**WHITE**  
alb / white  
GAKSE023

PEI 4 (mat | matt)  
PEI 2 (lucios | glossy)  
PEI 5 (mat | matt)

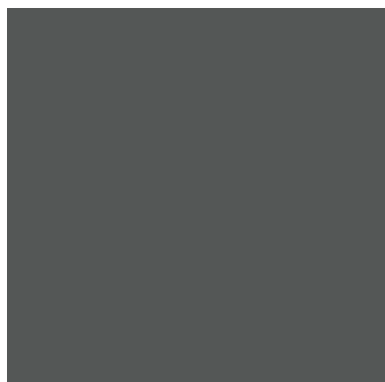

**RAL 0709010**  
bej deschis / light beige

PEI 4



**RAL 0508010**  
bej / beige

PEI 4



**RAL 0607020**  
bej închis / dark beige

PEI 3



**RAL 0607010**  
bej-gri / beige-grey

PEI 3



**RAL 0805010**  
gri / grey-beige

PEI 3

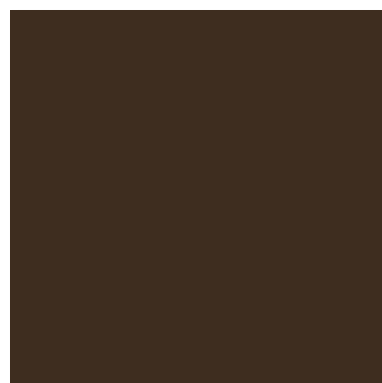

**RAL 0502010**  
maro închis / dark brown

PEI 2



**RAL 0304060** PEI 2  
roșu | red



**RAL 0506080** PEI 3  
orange | orange



**RAL 0607050** PEI 3  
orange deschis | light orange



**RAL 0858070** PEI 3  
galben închis / dark yellow



**RAL 0908040** PEI 4  
galben / yellow



**RAL 0958070** PEI 4  
galben-verde / yellow-green



**RAL 1208050** PEI 4  
verde deschis / light green



**RAL 1306050** PEI 3  
verde / green



**RAL 1907025** PEI 3  
turcoaz / turquoise



**RAL 2408015** PEI 4  
albastru deschis / light blue



**RAL 2606025** PEI 4  
albastru / blue



**RAL 2902035** PEI 3  
albastru închis / dark blue

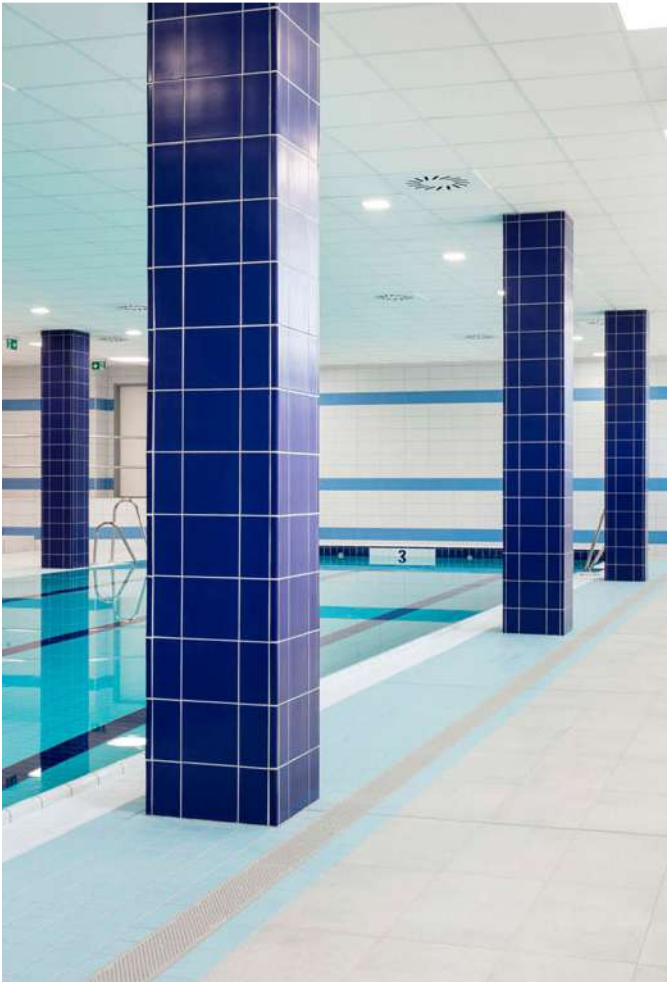
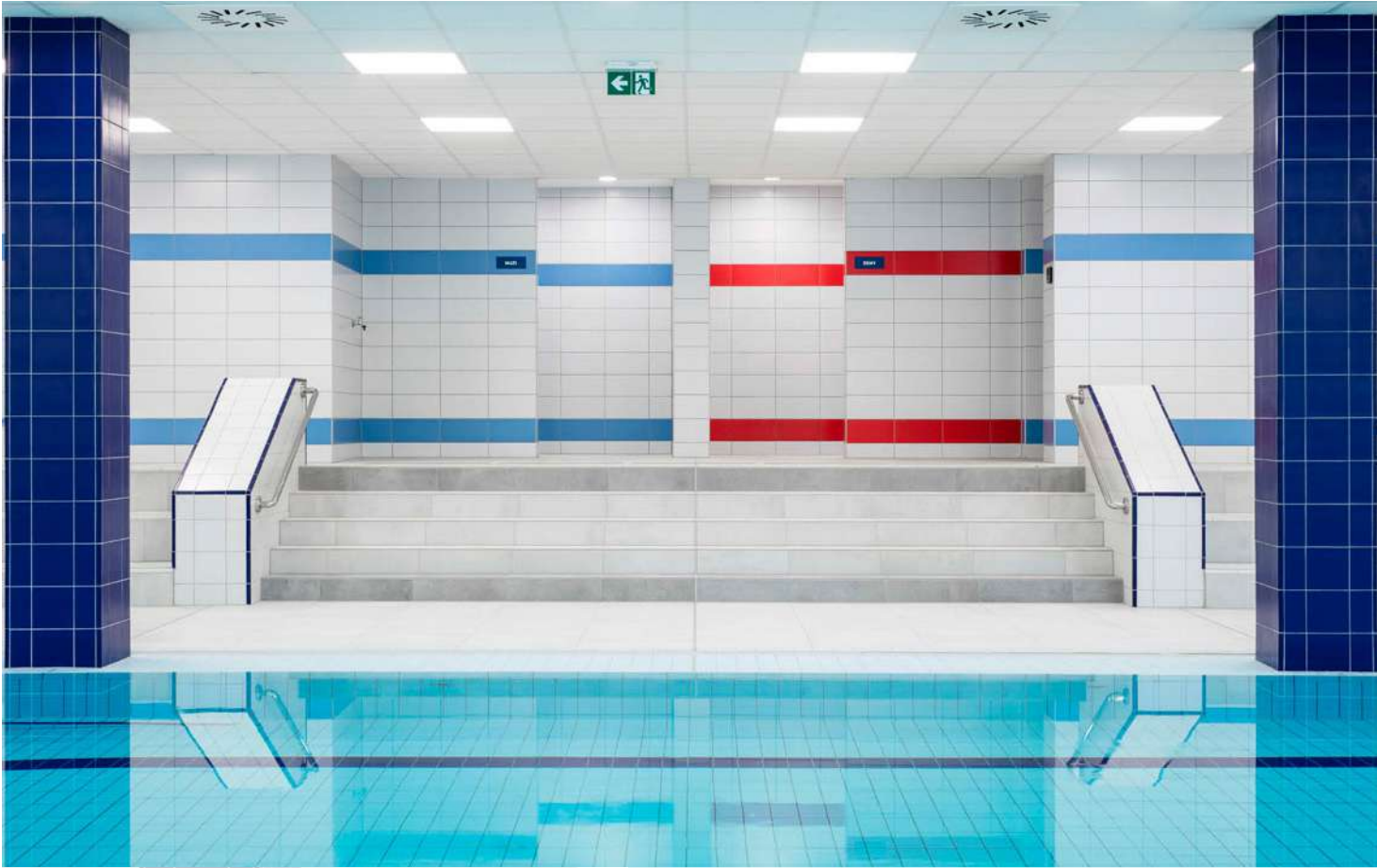

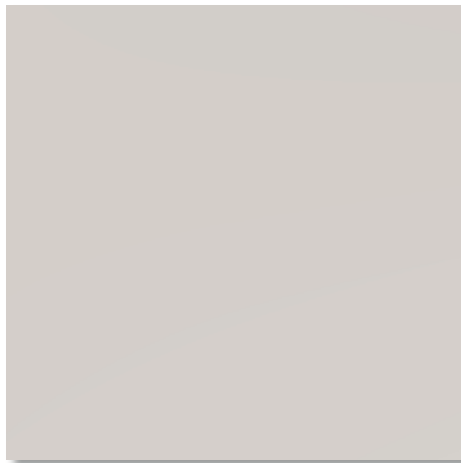

mat | matt  $\mu \geq 0,5$   
ABS R10/B  
 $\mu \geq 0,6$

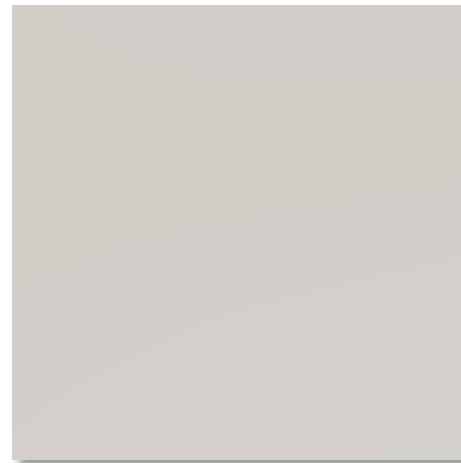

lucios | glossy  $\mu \geq 0,3$

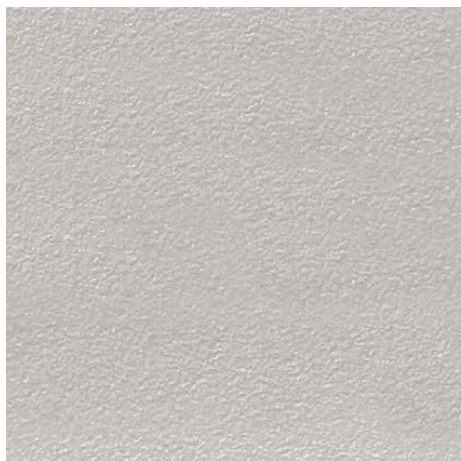

mat | matt R10/B  
GAF  $\mu \geq 0,6$

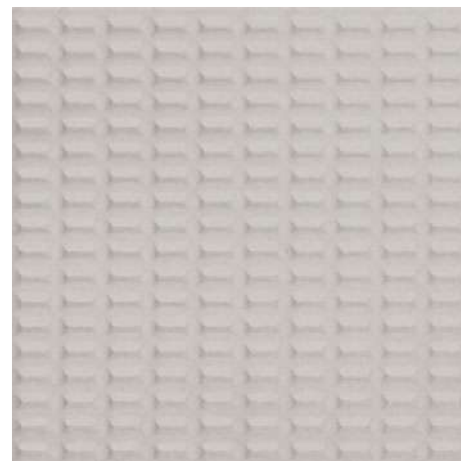

relief R10/B  
GRN  $\mu \geq 0,6$

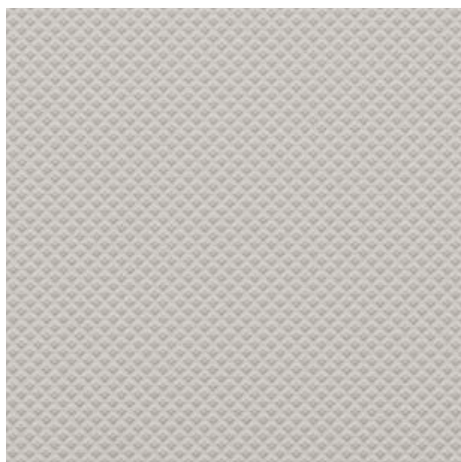

relief R10/B  
GRS  $\mu \geq 0,6$



relief GRH  $\mu \geq 0,7$   $\blacktriangleright$  C

**GAF** – Suprafață netedă, rezistentă la alunecare / Smooth slip-resistant surface  
**ABS** – Suprafață fină cu rezistență la alunecare R10/B / Smooth slip-resistant surface R10/B  
**GR** – Relief / Relief surface



## piese speciale / special pieces

**plintă cove** / cove skirting | **GST1K...** | 204×198×7 mm

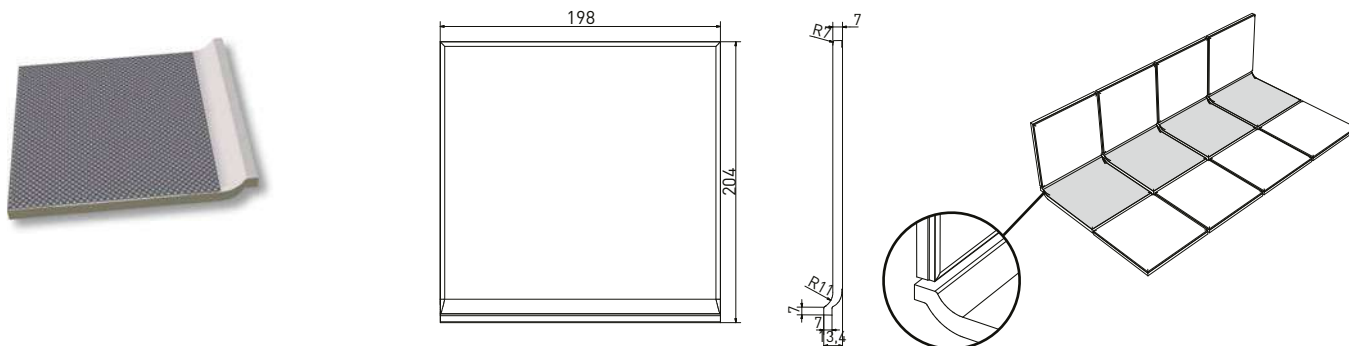

**plintă cove** / cove skirting | **GSP1K...** | 204×198×7 mm

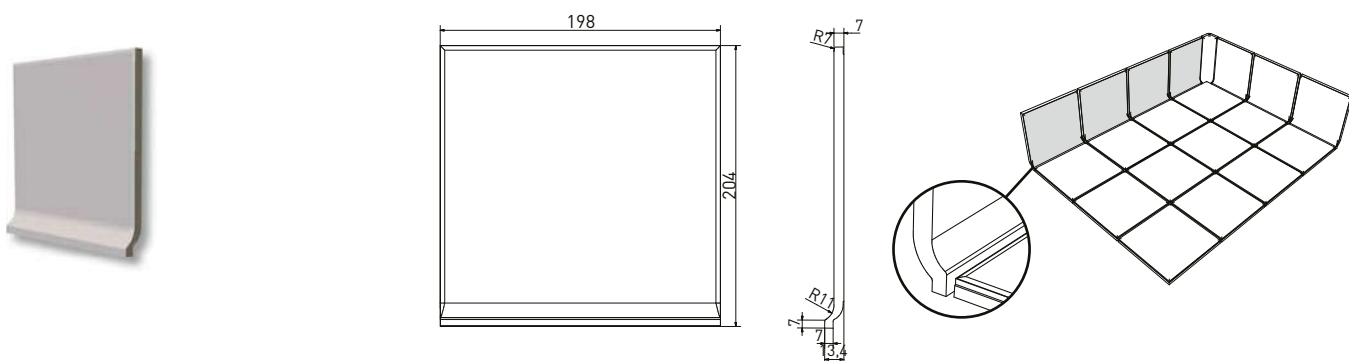

**colț exterior plintă cove** / inside corner cove skirting | **GSIRI...** | 204×24×7 mm

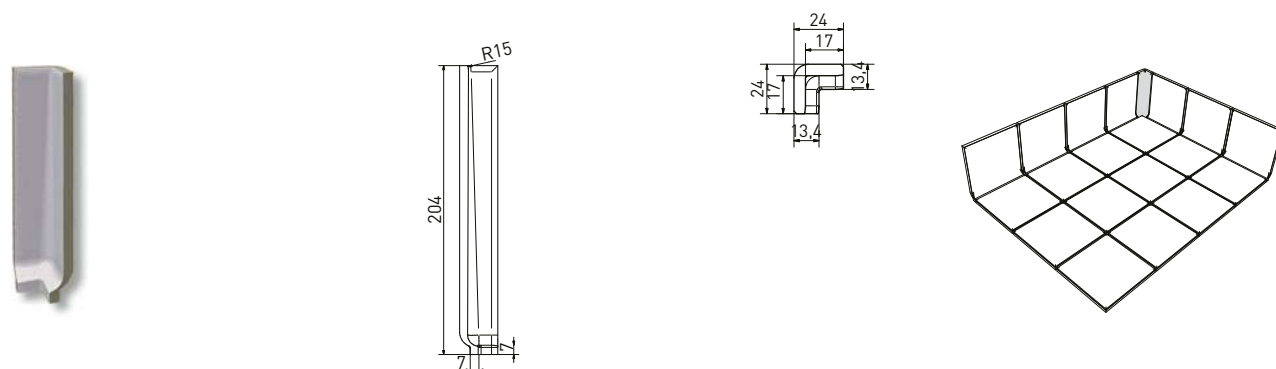



**colț exterior plintă cove** / outside corner cove skirting | **GSERI...** | 204×30×7 mm

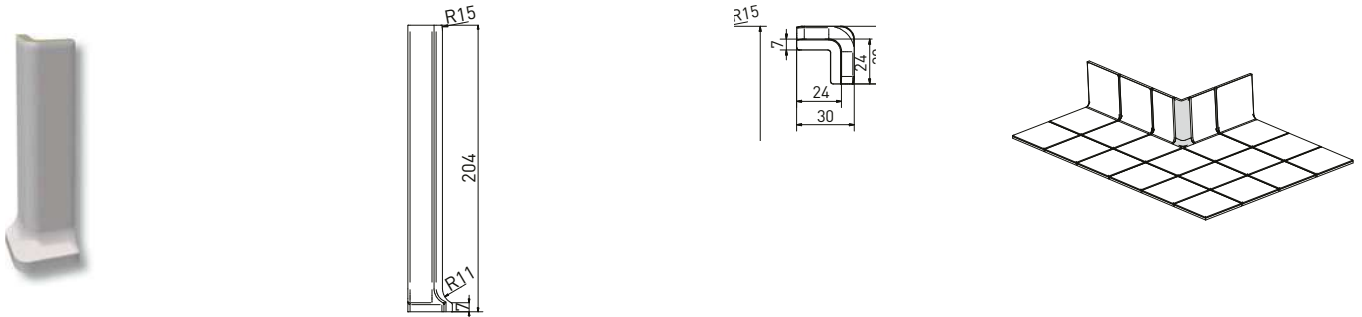

**colț interior duș** / inside edge - shower piece | **GSIAP...** | **GSIAPF...** | 198×24×7 mm

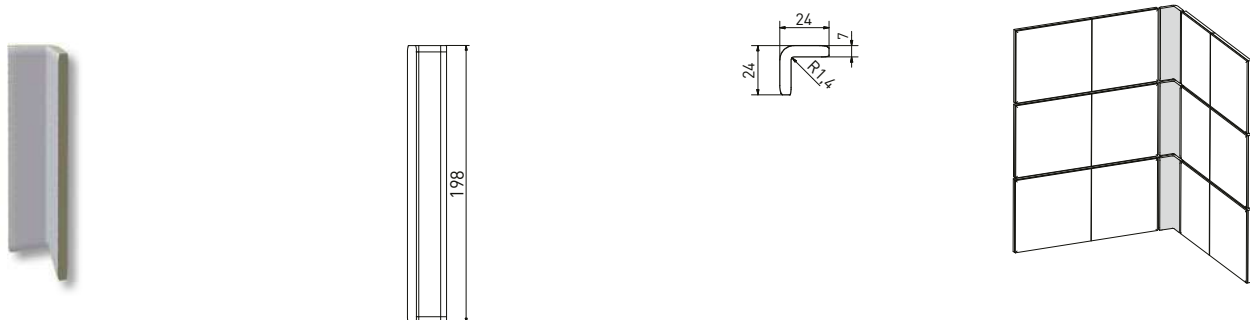

**colț exterior duș** / outside edge - shower piece | **GSEAP...** | **GSEAPF...** | 198×24×7 mm

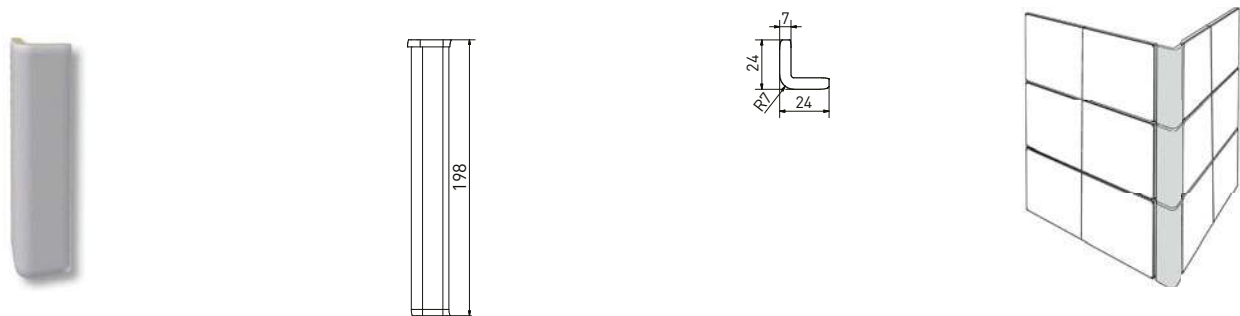







piese speciale / special pieces

colț exterior / outside corner | **GTVR4...** | **GTVR4F...** | 24x24x24 mm

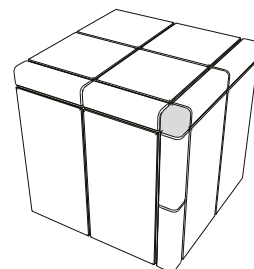
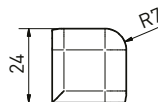
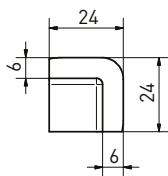

piesă colț de duș cu pantă / shower piece - corner | **GTRON...** | 98x98x6 mm

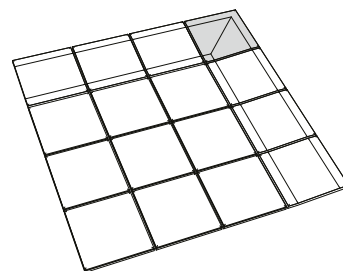
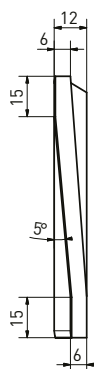
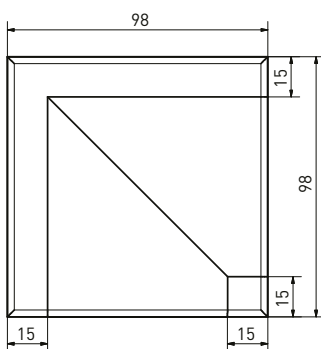
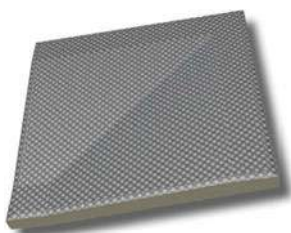

RAKO Object

piesă de duș cu pantă / shower piece - continuous | **GTPON...** | 98x98x6 mm

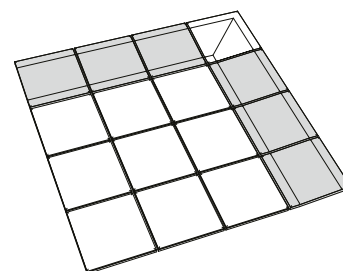
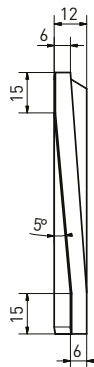
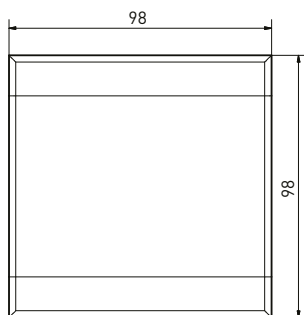
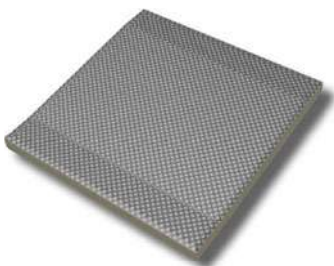

## STILURI MONTAJ

### 60 x 30 cm

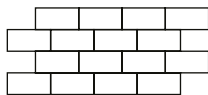

Se va monta cu un decalaj de maxim 18 cm

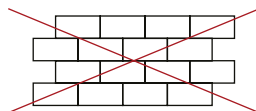
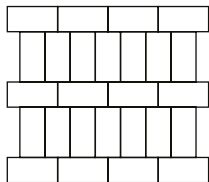

NU se va monta cu un decalaj de 30 cm

### 60 x 20 cm



Se va monta cu un decalaj de maxim 18 cm

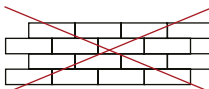
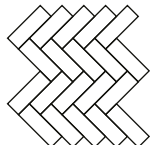
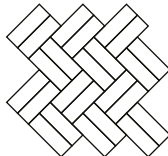

NU se va monta cu un decalaj de 30 cm

### 60 x 30 și 45 x 45 cm

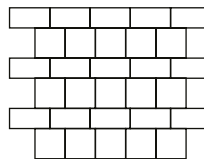

## RECOMANDĂRI PRIVIND UTILIZAREA PLĂCILOR CERAMICE

- La cumpărare asigurați-vă că plăcile cu același cod au același marcaj pe cutie, în ceea ce privește calitatea, nuanța, calibrul și data de fabricație.
- Pentru a obține un efect natural al suprafeței vă sugerăm ca înainte de a plasa o suprafață să selectați plăci din mai multe cutii și să le mixați între ele sau chiar să încercați rotirea plăcilor cu 180° sau 90°.
- Suprafața de montaj trebuie să fie corect pregătită pentru placare: rezistentă, fără denivelări, curată și uscată.
- Utilizați adezivi și chituri recomandate pentru plăci ceramice, ținând cont și de particularitățile suportului de montaj. Se recomandă flexibilizarea adezivilor rigizi sau folosirea adezivilor elastici în cazul suporturilor de montaj sensibile (gips, carton, BCA, plăci ipsos etc).
- Placarea se execută numai cu personal calificat respectând normele în vigoare.
- Înainte de montaj asigurați-vă că montatorul a citit toate recomandările și instrucțiunile de pe cutiile plăcilor ceramice. Studiați cu atenție și respectați instrucțiunile de utilizare furnizate de producătorii de adezivi, chituri și echipamente de tăiere a plăcilor ceramice.
- Nu folosiți produse abrazive pentru curățarea plăcilor ceramice pentru că pot afecta culoarea și suprafața acestora.
- Recomandăm folosirea detergenților menajeri diluați în apă.
- După montaj nu se acceptă reclamații referitoare la defectele vizibile, inițiale ale plăcilor.
- **Zona marcată pe cutie dă indicații asupra lotului (calibrul, nuanță, data de fabricație, calitate) și este utilă în caz de reprovizionare sau reclamații.**

## RECOMMENDATIONS REGARDING THE USE OF CERAMIC TILES:

- On purchasing, make sure that the tiles with the same code have the same information on the box regarding the quality, shade, caliber and production date.
- Before laying the tiles, we suggest you select from several boxes and mix the tiles to achieve a natural aspect including rotating them by 180° or 90°.
- The surface to be tiled must be correctly prepared: resistant, flat, clean and dry.
- Use adhesives and cement mortars recommended for setting ceramic tiles, also taking into account the particularities of the surface to be tiled. It is recommended to render the adhesive more flexible or to use elastic adhesives in the case of sensitive surfaces to be tiled (plasterboards, ACC, light panels, etc).
- The tiling must be performed only by qualified personnel, according to the norms in force.
- Study carefully and comply with the instructions provided by the manufacturers of adhesives, jointing materials and cutting instruments.
- Do not use abrasive products for cleaning, use only common household detergents diluted in water, other products may deteriorate the colors and surfaces.
- No complaints will be accepted after the tiling regarding initially visible defects of the tiles.
- **The marked area on the box indicates the batch (caliber, shade, production date, quality) and helps in case of purchase or claims.**

Culorile prezentate în acest catalog pot să difere față de culoarea reală a plăcilor ceramice.  
The colours you see in this catalogue may differ from the actual colour of the ceramic tiles.

# Marcaje importante pe ambalaj / Important markings on packaging

Cutie 120 x 20 cm



Cutie 60 x 60 cm



Cutie 120 x 60 cm

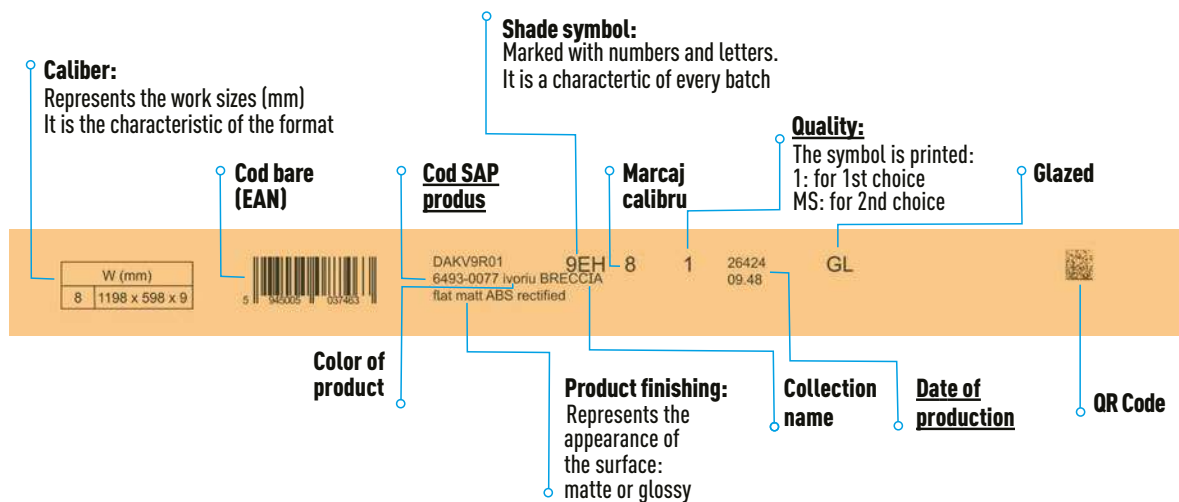
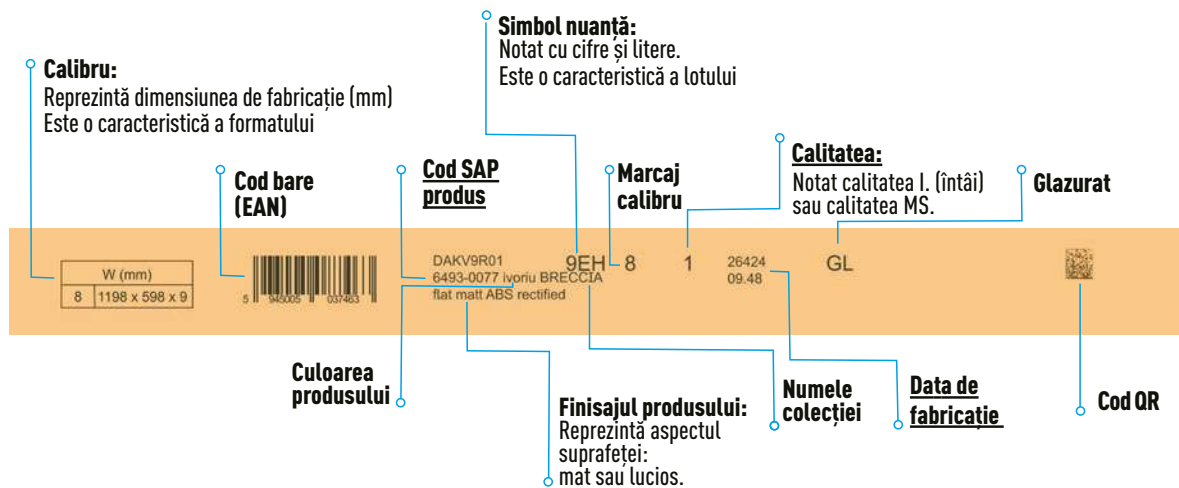

## CARACTERISTICI TEHNICE / TECHNICAL CHARACTERISTICS

**Plăci și dale ceramice presate uscat E> 10% Grupa B III (FAIANȚĂ) / Dry pressed ceramic tiles E > 10% Group B III (Wall tile)**

Caracteristici / Characteristics	Valori admise conform SR EN 14411 Admissible values – SR EN 14411 14411 Annex L, Group B III	Valori admise conform standardului SF / Admissible values according to SF Standard	Metoda de determinare / Test method
<b>A. Dimensiuni și calitatea suprafeței / Dimensions and surface quality</b>			
1. Lungime și lățime / Length and width	± 0.5 %	± 0.4 %	SR EN ISO 10545-2
2. Grosime / Thickness	± 10 %	± 5 %	SR EN ISO 10545-2
3. Liniaritatea muchiiilor / Edges linearity	± 0.3 %	± 0.2 %	SR EN ISO 10545-2
4. Rectangularitatea / Rectangularity	± 0.5 %	± 0.4 %	SR EN ISO 10545-2
5. Curbura centrală / Centre curvature	+ 0.5 % / - 0.3 %	+ 0.4 % / - 0.2 %	SR EN ISO 10545-2
6. Curbura laterală / Lateral curvature	+ 0.5 % / - 0.3 %	+ 0.4 % / - 0.2 %	SR EN ISO 10545-2
7. Voalul / Warpage	± 0.5 %	± 0.4 %	SR EN ISO 10545-2
8. Calitatea suprafeței / Surface quality	min. 95% din plăci nu prezintă defecte / min. 95% of tiles are without visible defects		SR EN ISO 10545-2
<b>B. Proprietăți fizice / Physical properties</b>			
1. Absorbția de apă / Water absorption	Media / Average > 10 % Valoare individuală / Individual value min. 9 %	10 ÷ 20 %	SR EN ISO 10545-3
2. Forța de rupere / Breaking strength a) grosimea / thickness ≥ 7,5 mm b) grosimea / thickness < 7,5 mm	≥ 600 N ≥ 200 N	≥ 600 N ≥ 200 N	SR EN ISO 10545-4
3. Rezistența la încovoiere / Modulus of rupture a) grosimea / thickness ≥ 7,5 mm b) grosimea / thickness < 7,5 mm	min. 12 N/mm <sup>2</sup> min. 15 N/mm <sup>2</sup>	min. 12 N/mm <sup>2</sup> min. 15 N/mm <sup>2</sup>	SR EN ISO 10545-4
4. Rezistența la harisare / Crazing resistance	Conform cerinței / As required	rezistă / resisting	SR EN ISO 10545-11
5. Rezistența la șoc termic / Thermal shock resistance	Conform cerinței / As required	rezista / resisting	SR EN ISO 10545-9
6. Coeficientul de dilatare termică liniară de la temperatura ambiantă la 100°C / Linear thermal expansion from ambient temperature of 100°C coefficient	Declarată de producător / Declared by manufacturer	max. 8X10 <sup>-6</sup> 1/K	SR EN ISO 10545-8
7. Dilatarea la umiditate / Dilation to humidity	Declarată de producător / Declared by manufacturer	max. 0.60 mm/m	SR EN ISO 10545-10
<b>C. Proprietăți chimice / Chemical properties</b>			
1. Rezistența la pătare / Resistance to staining	min. class 3	min. class 3	SR EN ISO 10545-14
2. Rezistența la produse chimice menajere / Resistance to household chemicals	min class B	min class A	SR EN ISO 10545-13
3. Rezistența la acizi și baze de concentrații mici / Resistance to acids and bases of low concentrations	Declarată de producător / Declared by manufacturer	min class LA	SR EN ISO 10545-13
4. Rezistența la acizi și baze de concentrații mari / Resistance to acids and bases of high concentrations	Declarată de producător / Declared by manufacturer	min class HB	SR EN ISO 10545-13
5. Emisie de plumb și cadmiu / Lead and Cadmium emission	Declarată de producător / Declared by manufacturer	Pb < 0,8 mg/dm <sup>2</sup> Cd < 0,07 mg/dm <sup>2</sup>	SR EN ISO 10545-15

**Plăci și dale ceramice presate uscat E ≤ 0,5% Grupa B la (GRESIE) / Dry pressed ceramic tiles**  
*E ≤ 0,5% Group B la (Floor tile)*

<b>Caracteristici / Characteristics</b>	<b>Valori admise conform SR EN 14411 / Admissible values - SR EN 14411 Annex G, Group B la</b>	<b>Valori admise conform standardului SF / Admissible values according to SF Standard</b>	<b>Metoda de determinare / Test method</b>
<b>A. Dimensiuni și calitatea suprafeței / Dimensions and surface quality</b>			
1. Lungime și lățime / Length and width	± 0,6 %	± 0,3 %	SR EN ISO 10545-2
2. Grosime / Thickness	± 5 %	± 5 %	SR EN ISO 10545-2
3. Liniaritatea muchiilor / Edge linearity	± 0,5 %	± 0,25 %	SR EN ISO 10545-2
4. Rectangularitatea / Rectangularity	± 0,5 %	± 0,3 %	SR EN ISO 10545-2
5. Curbura centrală / Central curvature	± 0,5 %	± 0,25 %	SR EN ISO 10545-2
6. Curbura laterală / Lateral curvature	± 0,5 %	± 0,25 %	SR EN ISO 10545-2
7. Voalul / Warpage	± 0,5 %	± 0,25 %	SR EN ISO 10545-2
8. Calitatea suprafeței / Surface Quality	min. 95% din plăci nu prezintă defecte / min. 95% of tiles are without visible defects		SR EN ISO 10545-2
<b>B. Proprietăți fizice / Physical properties</b>			
1. Absorbția de apă / Water absorption	E ≤ 0,5% individual max. 0,6 %	E ≤ 0,5% individual max. 0,6 %	SR EN ISO 10545-3
2. Forța de rupere / Breaking strength a) grosimea / thickness ≥ 7,5 mm b) grosimea / thickness < 7,5 mm	≥ 1300 N ≥ 700 N	≥ 1300 N ≥ 700 N	SR EN ISO 10545-4
3. Rezistența la încovoire / Modulus of rupture	min. 35 N/mm <sup>2</sup> individual min. 32 N/mm <sup>2</sup>	min. 35 N/mm <sup>2</sup> individual min. 32 N/mm <sup>2</sup>	SR EN ISO 10545-4
4. Rezistența la harisare / Crazeing resistance	Conform cerinței / As required	Rezistă / Resisting	SR EN ISO 10545-11
5. Rezistența la șoc termic / Thermal shock resistance	Conform cerinței / As required	Rezistă / Resisting	SR EN ISO 10545-9
6. Coeficientul de dilatare termică liniară de la temperatura ambiantă la 100°C / Linear thermal expansion from ambient temperature of 100°C coefficient	Declarată de producător / Declared by manufacturer	max. 8X10 <sup>-6</sup> 1/K	SR EN ISO 10545-8
7. Rezistența la abraziune / Resistance to abrasion			
a) Rezistență la abraziune profundă a plăcilor neglazurate (UGL) / Resistance to deep abrasion of unglazed tiles	max. 175 mm <sup>2</sup>	max. 175 mm <sup>2</sup>	SR EN ISO 10545-6
b) Rezistența la abraziune a plăcilor glazurate (GL) / Resistance to abrasion of glazed tiles	Declarată de producător / Declared by manufacturer	PEI 3÷5	SR EN ISO 10545-7
8. Rezistența la alunecare / Slip resistance	Declarată de producător / Declared by manufacturer	Declarată de producător / Declared by manufacturer	CEN/TS 16165
9. Rezistența la îngheț / Frost resistance	Conform cerinței// As required	Rezistă// Resisting	SR EN ISO 10545-12
<b>C. Proprietăți chimice/ Chemical properties</b>			
1. Rezistența la pătare/ Resistance to staining			
a) Plăci glazurate / Glazed tiles	min. class 3	min. class 3	SR EN ISO 10545-14
b) Plăci neglazurate / Unglazed tiles	Declarată de producător / Declared by manufacturer	min. class 3	SR EN ISO 10545-14
2. Rezistența la produse chimice menajere / Resistance to household chemicals	min. class B	min. class A	SR EN ISO 10545-13
3. Rezistența la acizi și baze de concentrații mici / Resistance to acids and bases of low conc.	Declarată de producător / Declared by manufacturer	min. class LA	SR EN ISO 10545-13
4. Rezistența la acizi și baze de concentrații mari / Resistance to acids and bases of high conc.	Declarată de producător / Declared by manufacturer	min class HB	SR EN ISO 10545-13
5. Emisie de plumb și cadmiu / Lead and Cadmium emissions	Declarată de producător / Declared by manufacturer	Pb < 0,8 mg/dm <sup>2</sup> Cd < 0,07 mg/dm <sup>2</sup>	SR EN ISO 10545-15

# Gresie și faianță CESAROM® 10 ANI GARANȚIE

ABAETE	Gresie porțelanată CESAROM 33x33	6035-0350	ColorLine	Faianță CESAROM 50x25	2051-0154	FIRENZE	Faianță CESAROM 60x30	2060-0105
ANCIENT	Gresie porțelanată CESAROM 45x45	6046-0403	ColorLine	Faianță CESAROM 50x25	2051-0201	FIRENZE	Faianță CESAROM 60x30	2060-0106
ANNEX	Gresie porțelanată CESAROM 45x45	6046-0140	ColorLine	Faianță CESAROM 50x25	2051-0200	FLAKES	Gresie porțelanată CESAROM 45x45	6046-0439
ARA	Faianță CESAROM 50x25	2051-0187	ColorLine	Faianță CESAROM 50x25	2051-0157	GARDEN	Gresie porțelanată CESAROM 33x33	6035-0328
ARA	Faianță CESAROM 50x25	2051-0188	ColorLine	Gresie porțelanată CESAROM 33x33	6035-0345	GARDENA	Gresie porțelanată CESAROM 45x45	6046-0517
ARA	Faianță CESAROM 50x25	2051-0180	ColorLine	Gresie porțelanată CESAROM 33x33	6035-0329	GARRET	Gresie porțelanată CESAROM 60x30	6060-0302
ARA	Faianță CESAROM 50x25	2051-0179	CONCEPTO	Faianță CESAROM 60x30 R	1260-0075	GARRET	Gresie porțelanată CESAROM 60x30	6060-0301
ARA	Gresie porțelanată CESAROM 33x33	6035-0353	CONCEPTO	Faianță CESAROM 60x30 R	1260-0076	GEOSTONE	Gresie porțelanată CESAROM 33x33	6035-0240
ARGILA	Gresie porțelanată CESAROM 33x33	6035-0358	CONCEPTO	Faianță CESAROM 60x30 R	1260-0077	GRANITO	Gresie porțelanată CESAROM 60x30 safe+	6060-0271
BRECCIA	Gresie porțelanată CESAROM 60x30 R safe+	6460-0298	CONCEPTO	Faianță CESAROM 60x30 R	1260-0181	GRANITO	Gresie porțelanată CESAROM 60x30 safe+	6060-0282
BRECCIA	Gresie porțelanată CESAROM 60x30 R safe+	6460-0297	CONCEPTO	Faianță CESAROM 60x30 R	1260-0182	GRANITO	Gresie porțelanată CESAROM 33x33	6035-0344
BRECCIA	Gresie porțelanată CESAROM 60x60 R	6461-0324	CONCEPTO	Faianță CESAROM 60x30 R	1260-0183	GRANITO	Gresie porțelanată CESAROM 33x33	6035-0354
BRECCIA	Gresie porțelanată CESAROM 60x60 R	6461-0325	CONCEPTO	Faianță CESAROM 90x30 R	1296-0014	GRANITO	Treaptă CESAROM 60x30 safe+	6806-0038
BRECCIA	Gresie porțelanată CESAROM 60x60 R	6461-0326	CONCEPTO	Faianță CESAROM 90x30 R	1296-0015	GRANITO	Treaptă CESAROM 60x30 safe+	6806-0039
BRECCIA	Gresie porțelanată CESAROM 120x60 R	6493-0075	CONCRETE	Faianță CESAROM 60x30	2060-0128	GRECIA	Gresie porțelanată CESAROM 33x33	6035-0241
BRECCIA	Gresie porțelanată CESAROM 120x60 R	6493-0076	CONCRETE	Faianță CESAROM 60x30	2060-0119	LEGNO CLASSICO	Gresie porțelanată CESAROM 60x15 R safe+	6463-0041
BRECCIA	Gresie porțelanată CESAROM 120x60 R	6493-0077	CONCRETE	Faianță CESAROM 60x30	2060-0127	LEGNO CLASSICO	Gresie porțelanată CESAROM 60x15 R safe+	6463-0042
BRECCIA	Treaptă CESAROM 120x30 R	6895-0048	CONCRETE	Faianță CESAROM 60x30	2060-0120	LEGNO CLASSICO	Gresie porțelanată CESAROM 60x30 R safe+	6460-0287
BRECCIA	Treaptă CESAROM 120x30 R	6895-0049	CONCRETE	Gresie porțelanată CESAROM 45x45	6046-0529	LEGNO CLASSICO	Gresie porțelanată CESAROM 60x30 R safe+	6460-0288
BRECCIA	Treaptă CESAROM 120x30 R	6895-0050	CREAM	Faianță CESAROM 60x30	2060-0114	LEGNO MIELE	Gresie porțelanată CESAROM 60x15 R safe+	6463-0053
BRECCIA	Treaptă CESAROM 60x30 R safe+	6806-0056	CREAM	Faianță CESAROM 60x30	2060-0115	LUBERON	Gresie porțelanată CESAROM 60x30 safe+	6060-0249
BRECCIA	Treaptă CESAROM 60x30 R safe+	6806-0060	CREAM	Gresie porțelanată CESAROM 60x30	6060-0196	LUBERON	Treaptă CESAROM 60x30 safe+	6806-0052
CALACATTA ORO	Gresie porțelanată CESAROM 45x45	6046-0524	CREAM	Gresie porțelanată CESAROM 60x30	6060-0195	LUX NERO	Gresie porțelanată CESAROM 60x60 R, mat	6461-0323
CALACATTA ORO	Gresie porțelanată CESAROM 45x45	6046-0523	CREAM	Gresie porțelanată CESAROM 45x45	6046-0530	LUX NERO	Treaptă CESAROM 60x30 R, mat	6806-0068
CAMINO	Gresie porțelanată CESAROM 60x30	6060-0192	CREATIVO	Faianță CESAROM 50x25	2051-0199	LUX SPIDER	Gresie porțelanată CESAROM 60x60 R, mat	6461-0322
CAMINO	Gresie porțelanată CESAROM 60x30	6060-0193	CREATIVO	Faianță CESAROM 50x25	2051-0198	LUX SPIDER	Gresie porțelanată CESAROM 120x60 R, mat	6493-0074
CANADA	Gresie porțelanată CESAROM 60x30	6060-0098	CREATIVO	Gresie porțelanată CESAROM 45x45	6046-0452	LUX SPIDER	Treaptă CESAROM 60x30 R, mat	6806-0067
CANADA	Gresie porțelanată CESAROM 60x30	6060-0099	CROMATIC	Faianță CESAROM 50x25	2051-0155	LUX SPIDER	Treaptă CESAROM 120x30 R, mat	6895-0047
CANADA	Gresie porțelanată CESAROM 60x30	6060-0105	CROMATIC	Faianță CESAROM 50x25	2051-0156	MAGMA	Gresie porțelanată CESAROM 45x45	6046-0534
CANADA	Gresie porțelanată CESAROM 60x30	6060-0101	CROMATIC GLOSS	Faianță CESAROM 50x25	2051-0152	MAYENNE	Gresie porțelanată CESAROM 45x45	6046-0367
CANADA	Gresie porțelanată CESAROM 60x30	6060-0100	CROMATIC GLOSS	Faianță CESAROM 50x25	2051-0210	MAYENNE	Gresie porțelanată CESAROM 45x45	6046-0368
CELLIN	Gresie porțelanată CESAROM 60x30	6060-0187	CROMATIC GLOSS	Faianță CESAROM 50x25	2051-0212	MIRAGE	Faianță CESAROM 60x30	2060-0131
CEMENTINO	Gresie porțelanată CESAROM 60x30 R safe+	6460-0300	CROMATIC GLOSS	Faianță CESAROM 50x25	2051-0211	MOTIVE TEX	Faianță CESAROM 50x25	2051-0102
CEMENTINO	Gresie porțelanată CESAROM 60x30 R safe+	6460-0301	CRUST	Gresie porțelanată CESAROM 60x30 safe+	6060-0191	MOTIVE TEX	Faianță CESAROM 50x25	2051-0101
CEMENTINO	Treaptă CESAROM 60x30 R safe+	6806-0054	CRUST	Gresie porțelanată CESAROM 60x30 safe+	6060-0211	MOTIVE TEX	Gresie porțelanată CESAROM 33x33	6035-0196
CEMENTINO	Treaptă CESAROM 60x30 R safe+	6806-0055	CRUST	Gresie porțelanată CESAROM 60x30 safe+	6060-0190	MOVE	Gresie porțelanată CESAROM 60x30 safe+	6060-0281
CEMEWOOD	Gresie porțelanată CESAROM 60x30	6060-0285	CRUST	Gresie porțelanată CESAROM 45x45	6046-0366	MOVE	Gresie porțelanată CESAROM 60x30 safe+	6060-0284
CEMEWOOD	Gresie porțelanată CESAROM 60x30	6060-0286	CRUST	Gresie porțelanată CESAROM 60x30 R safe+	6460-0271	MOVE	Gresie porțelanată CESAROM 60x30 safe+	6060-0283
CEPPO DI GRE	Gresie porțelanată CESAROM 60x30 R safe+	6460-0302	CRUST	Gresie porțelanată CESAROM 60x30 R safe+	6460-0272	MOVE	Gresie porțelanată CESAROM 60x30 R safe+	6460-0276
CEPPO DI GRE	Gresie porțelanată CESAROM 60x30 R safe+	6460-0303	CRUST	Treaptă CESAROM 60x30 R safe+	6806-0037	MOVE	Gresie porțelanată CESAROM 60x30 R safe+	6460-0277
CEPPO DI GRE	Gresie porțelanată CESAROM 60x60 R	6461-0333	DECORA	Gresie porțelanată CESAROM 45x45	6046-0522	MUSTIQUE	Gresie porțelanată CESAROM 60x30	6060-0199
CEPPO DI GRE	Gresie porțelanată CESAROM 60x60 R	6461-0334	DECORA	Gresie porțelanată CESAROM 33x33	6035-0361	MUSTIQUE	Gresie porțelanată CESAROM 60x30	6060-0207
CEPPO DI GRE	Gresie porțelanată CESAROM 120x60 R	6493-0081	DUNE	Gresie porțelanată CESAROM 45x45	6046-0360	MUSTIQUE	Gresie porțelanată CESAROM 60x30	6060-0206
CEPPO DI GRE	Gresie porțelanată CESAROM 120x60 R	6493-0082	ESSENTIAL	Gresie porțelanată CESAROM 60x30 safe+	6060-0334	MUSTIQUE	Gresie porțelanată CESAROM 60x30	6060-0198
CEPPO DI GRE	Treaptă CESAROM 120x30 R	6895-0054	ESSENTIAL	Gresie porțelanată CESAROM 60x30 safe+	6060-0335	MUSTIQUE	Gresie porțelanată CESAROM 60x30	6060-0197
CEPPO DI GRE	Treaptă CESAROM 120x30 R	6895-0055	ESSENTIAL	Gresie porțelanată CESAROM 60x30 safe+	6060-0333	NALIM	Faianță CESAROM 50x25	2051-0177
CEPPO DI GRE	Treaptă CESAROM 60x30 R safe+	6806-0061	ESSENTIAL	Gresie porțelanată CESAROM 60x30 R safe+	6460-0280	NALIM	Faianță CESAROM 50x25	2051-0178
CEPPO DI GRE	Treaptă CESAROM 60x30 R safe+	6806-0062	ESSENTIAL	Gresie porțelanată CESAROM 60x30 R safe+	6460-0279	NALIM	Faianță CESAROM 50x25	2051-0175
CITY	Faianță CESAROM 60x30 R	1260-0082	ETNA	Gresie porțelanată CESAROM 60x30 R safe+	6460-0299	NALIM	Faianță CESAROM 50x25	2051-0176
CITY	Faianță CESAROM 60x30 R	1260-0083	ETNA	Treaptă CESAROM 60x30 R safe+	6806-0053	NALIM	Gresie porțelanată CESAROM 45x45	6046-0437
ColorLine	Faianță CESAROM 50x25	2051-0169	FABRIC	Gresie porțelanată CESAROM 33x33	6035-0340	NATURA	Gresie porțelanată CESAROM 45x45	6046-0450
ColorLine	Faianță CESAROM 50x25	2051-0153	FERRARA	Faianță CESAROM 60x30	2060-0136	NATURA	Gresie porțelanată CESAROM 45x45	6046-0451

NATURA	Gresie porțelanată CESAROM 45x45	6046-0451	ROVERE	Gresie porțelanată CESAROM 120x20 R	6494-0018	THERME	Faianță CESAROM 60x30	2060-0138
NATURA	Gresie porțelanată CESAROM 45x45	6046-0450	SOFT	Faianță CESAROM 50x25	2051-0167	THERME	Faianță CESAROM 60x30	2060-0139
NEWTEX	Faianță CESAROM 50x25	2051-0163	SOFT	Faianță CESAROM 50x25	2051-0165	TOBACO	Gresie porțelanată CESAROM 60x30	6060-0208
NEWTEX	Faianță CESAROM 50x25	2051-0164	SOFT	Faianță CESAROM 50x25	2051-0166	TOBACO	Gresie porțelanată CESAROM 60x30	6060-0209
NORDIC WOOD	Gresie porțelanată CESAROM 45x45	6046-0406	SOFT	Gresie porțelanată CESAROM 33x33	6035-0346	TOBACO	Gresie porțelanată CESAROM 60x30	6060-0204
NORDIC WOOD	Gresie porțelanată CESAROM 45x45	6046-0513	SOFTWOOD	Faianță CESAROM 50x25	2051-0148	TRAVER	Gresie porțelanată CESAROM 60x30 safe+	6060-0203
NORWAY	Gresie porțelanată CESAROM 45x45	6046-0136	SOFTWOOD	Faianță CESAROM 50x25	2051-0161	TRAVER	Gresie porțelanată CESAROM 60x30 safe+	6060-0336
NORWAY	Gresie porțelanată CESAROM 45x45	6046-0137	SOFTWOOD	Faianță CESAROM 50x25	2051-0162	TRAVER	Gresie porțelanată CESAROM 60x30 safe+	6060-0202
ODILE	Gresie porțelanată CESAROM 45x45	6046-0514	SOFTWOOD	Gresie porțelanată CESAROM 33x33	6035-0349	TRAVER	Gresie porțelanată CESAROM 60x30 R safe+	6460-0278
PARQUET	Gresie porțelanată CESAROM 45x45	6046-0404	STATUARIO	Faianță CESAROM 50x25	2051-0207	TRAVER	Treaptă CESAROM 60x30 safe+	6806-0044
PAVIMENTO	Gresie porțelanată CESAROM 60x15 R safe+	6463-0033	STATUARIO	Faianță CESAROM 50x25	2051-0208	TRAVERTINE	Gresie porțelanată CESAROM 45x45	6046-0131
PAVIMENTO	Gresie porțelanată CESAROM 60x15 R safe+	6463-0031	STATUARIO	Gresie porțelanată CESAROM 45x45	6046-0519	TRENDY	Faianță CESAROM 60x30 R	1260-0080
PAVIMENTO	Gresie porțelanată CESAROM 60x15 R safe+	6463-0032	STATUARIO	Gresie porțelanată CESAROM 60x30 safe+	6060-0352	TRENDY	Faianță CESAROM 60x30 R	1260-0081
PEARL	Gresie porțelanată CESAROM 45x45	6046-0402	STATUARIO	Gresie porțelanată CESAROM 60x30 safe+	6060-0351	TRENDY	Faianță CESAROM 60x30 R	1260-0104
PERFECT	Faianță CESAROM 60x30	2060-0132	STATUARIO	Gresie porțelanată CESAROM 60x30 R safe+	6460-0275	TRENDY	Faianță CESAROM 60x30 R	1260-0105
PIEDRA	Gresie porțelanată CESAROM 60x30 safe+	6060-0296	STATUARIO	Treaptă CESAROM 60x30 R safe+	6806-0045	UNIQUE	Faianță CESAROM 60x30	2060-0125
PIEDRA	Gresie porțelanată CESAROM 60x30 safe+	6060-0297	STRIPES	Faianță CESAROM 50x25	2051-0109	UNIQUE	Faianță CESAROM 60x30	2060-0101
PIEDRA	Gresie porțelanată CESAROM 60x30 R safe+	6460-0273	STRIPES	Faianță CESAROM 50x25	2051-0108	UNIQUE	Faianță CESAROM 60x30	2060-0121
PIEDRA	Gresie porțelanată CESAROM 60x30 R safe+	6460-0274	STRIPES	Gresie porțelanată CESAROM 33x33	6035-0194	UNIQUE	Faianță CESAROM 60x30	2060-0108
PIEDRA	Treaptă CESAROM 60x30 R safe+	6806-0041	STRIPES	Faianță CESAROM 50x25	2051-0117	UNIQUE	Faianță CESAROM 60x30	2060-0102
PIEDRA	Treaptă CESAROM 60x30 R safe+	6806-0040	STRIPES	Gresie porțelanată CESAROM 33x33	6035-0195	UNIQUE	Faianță CESAROM 60x30	2060-0122
PIEDRA	Gresie porțelanată CESAROM 45x45	6046-0419	TANUM	Faianță CESAROM 60x30	2060-0109	UNIQUE	Faianță CESAROM 60x30	2060-0117
PIEDRA	Gresie porțelanată CESAROM 45x45	6046-0420	TANUM	Faianță CESAROM 60x30	2060-0110	UNIQUE	Faianță CESAROM 60x30	2060-0103
PULPIS	Faianță CESAROM 60x30	2060-0134	TANUM	Gresie porțelanată CESAROM 33x33	6035-0181	UNIQUE	Faianță CESAROM 60x30	2060-0104
PULPIS	Faianță CESAROM 60x30	2060-0135	TANUM	Gresie porțelanată CESAROM 60x30 safe+	6060-0125	UNIQUE	Faianță CESAROM 60x30	2060-0124
PURITY	Faianță CESAROM 60x30	2060-0116	TANUM	Gresie porțelanată CESAROM 60x30 safe+	6060-0126	UNIQUE	Faianță CESAROM 60x30	2060-0130
QUARTZ	Gresie porțelanată CESAROM 60x30 safe+	6060-0353	TANUM	Gresie porțelanată CESAROM 60x30 safe+	6060-0124	UNIQUE	Faianță CESAROM 60x30	2060-0123
QUARTZ	Gresie porțelanată CESAROM 60x30 safe+	6060-0354	TANUM	Gresie porțelanată CESAROM 60x30 safe+	6060-0127	UNIQUE	Faianță CESAROM 60x30	2060-0133
QUARTZ	Gresie porțelanată CESAROM 60x30 safe+	6060-0355	TANUM	Gresie porțelanată CESAROM 60x30 R safe+	6460-0269	VENICE	Faianță CESAROM 60x30 R	1260-0078
QUARTZ	Gresie porțelanată CESAROM 60x30 R safe+	6460-0268	TANUM	Gresie porțelanată CESAROM 60x30 R safe+	6460-0270	VENICE	Faianță CESAROM 60x30 R	1260-0079
QUARTZ	Gresie porțelanată CESAROM 60x30 R safe+	6460-0267	TANUM	Treaptă CESAROM 60x30 R safe+	6806-0047	WRIGHT	Gresie porțelanată CESAROM 60x30 safe+	6060-0299
QUARTZ	Gresie porțelanată CESAROM 60x30 R safe+	6460-0289	TANUM	Treaptă CESAROM 60x30 R safe+	6806-0046	WRIGHT	Gresie porțelanată CESAROM 60x30 safe+	6060-0300
QUARTZ	Treaptă CESAROM 60x30 R safe+	6806-0043	TERRA	Gresie porțelanată CESAROM 45x45	6046-0518	WRIGHT	Gresie porțelanată CESAROM 60x30 safe+	6060-0298
QUARTZ	Treaptă CESAROM 60x30 R safe+	6806-0042	TERRAZZINO	Gresie porțelanată CESAROM 60x30 safe+	6060-0356	YARD	Gresie porțelanată CESAROM 45x45	6046-0438
QUARTZITE	Gresie porțelanată CESAROM 33x33	6035-0197	TERRAZZO	Gresie porțelanată CESAROM 60x30	6060-0210			
RAPOLANO	Gresie porțelanată CESAROM 60x30	6060-0131	TEXTURE	Gresie porțelanată CESAROM 33x33	6035-0262			
RAPOLANO	Gresie porțelanată CESAROM 60x30	6060-0128	THERME	Gresie porțelanată CESAROM 60x30 R safe+	6460-0294			
RAPOLANO	Gresie porțelanată CESAROM 60x30	6060-0129	THERME	Gresie porțelanată CESAROM 60x30 R safe+	6460-0295			
RAPOLANO	Gresie porțelanată CESAROM 45x45	6046-0156	THERME	Gresie porțelanată CESAROM 60x30 R safe+	6460-0296			
RAPOLANO	Gresie porțelanată CESAROM 45x45	6046-0157	THERME	Gresie porțelanată CESAROM 60x60 R	6461-0330			
RETROWOOD	Gresie porțelanată CESAROM 60x30	6060-0247	THERME	Gresie porțelanată CESAROM 60x60 R	6461-0331			
RETROWOOD	Gresie porțelanată CESAROM 60x30	6060-0248	THERME	Gresie porțelanată CESAROM 60x60 R	6461-0332			
RIVER STONES	Gresie porțelanată CESAROM 60x30	6060-0254	THERME	Gresie porțelanată CESAROM 120x60 R	6493-0078			
ROMA	Gresie porțelanată CESAROM 45x45	6046-0152	THERME	Gresie porțelanată CESAROM 120x60 R	6493-0079			
ROMANTICA	Gresie porțelanată CESAROM 33x33	6035-0224	THERME	Gresie porțelanată CESAROM 120x60 R	6493-0080			
ROMANTICA	Gresie porțelanată CESAROM 33x33	6035-0226	THERME	Treaptă CESAROM 60x30 R safe+	6806-0058			
ROMANTICA	Gresie porțelanată CESAROM 33x33	6035-0222	THERME	Treaptă CESAROM 60x30 R safe+	6806-0057			
ROVERE	Gresie porțelanată CESAROM 60x15 R safe+	6463-0037	THERME	Treaptă CESAROM 60x30 R safe+	6806-0059			
ROVERE	Gresie porțelanată CESAROM 60x15 R safe+	6463-0043	THERME	Treaptă CESAROM 120x30 R	6895-0051			
ROVERE	Gresie porțelanată CESAROM 60x30 R safe+	6460-0284	THERME	Treaptă CESAROM 120x30 R	6895-0052			
ROVERE	Gresie porțelanată CESAROM 60x30 R safe+	6460-0285	THERME	Treaptă CESAROM 120x30 R	6895-0053			
ROVERE	Gresie porțelanată CESAROM 120x20 R	6494-0017	THERME	Faianță CESAROM 60x30	2060-0137			

**activează**



**10 ani garanție**

**și manopera înapoi.**

**AEROQ**  
Organism Acreditat pentru Certificarea Sistemelor de Management - SR EN ISO/CEI 17021-1  
Membro Asociat la Organizația Europeană pentru Calitate - EOQ

**CERTIFICAT**  
nr.: 1820

Se certifică Sistemul de Management al Calității al  
**SANEX S.A.**  
România, Cluj-Napoca, Strada Beiușului, nr. 1, Județul Cluj

Care este conform cu:  
**SR EN ISO 9001:2015, EN ISO 9001:2015**

Domeniu: Proiectarea, fabricarea și comercializarea plăcilor ceramice presate uscat pentru finisarea pereților și a pardoselilor interioare și/sau exterioare.

Precizări suplimentare privind aplicabilitatea cerințelor ISO 9001:2015 și domeniul cuprins în acest certificat pot fi găsite prin consultarea organizației.

Referințe: Certificat de acreditare RENAR nr. SM 003/05.05.2023  
Raport audit nr. 2015/17.07.2013

Data recertificării: 21.07.2023      Data expirării: 04.06.2026      Data certificării inițiale: 22.07.2008

Valabilitatea certificatului este condiționată de efectuarea auditurilor de supraveghere anuale, confirmată prin rapoartele de audit și de reevaluarea completă ori cu recertificarea acestuia înainte de expirarea perioadei de valabilitate (3 ani).  
Acest certificat poate fi suspendat sau retras, dacă prin auditurile de supraveghere se constată că nu se mențin condițiile în baza cărora a fost emis.

Director General  
Ing. **Constantin AVRAM**

F-101R-96 / Ed. 11      AEROQ S.A. - Strada Feleacu, nr. 14 B, Sector 1, București, România

**AEROQ**  
Organism pentru Certificarea Conformității Producător  
SR EN ISO/CEI 17065:2013  
Body for Product Conformity Certification  
SR EN ISO/CEI 17065:2013

**CERTIFICAT DE CONFORMITATE**  
CERTIFICATE OF CONFORMITY  
nr.: 150

Produsul: This is to certify that  
**PLĂCI CERAMICE PRESATE USCAT FAIANTA; BRĂURI ȘI MEDALIOANE, cu absorbție de apă E>10%, grupa B III din domeniul de utilizare: finisarea pereților interiori**

fabricat de/ manufactured by: **SANEX S.A.**  
cu sediul în/ located at: **Cluj-Napoca, Strada Beiușului, nr. 1, Județul Cluj**

în fabrica / in factory: **SANEX S.A.**  
cu sediul în/ located at: **Cluj-Napoca, Strada Beiușului, nr. 1, Județul Cluj**

îndeplinește cerințele din: **SR EN 14411: 2012**

Schema de certificare a produsului / Product certification scheme:  
2 (similar schema 4 din SR EN ISO/CEI 17067) / like scheme 4 of SR EN ISO/CEI 17067  
"Seleția (planificarea și pregătirea, specificarea cerințelor), determinarea caracteristicilor (mecurii, verificarea proiectului, evaluarea serviciilor sau a proceselor, verificarea analizei (examinarea dovezilor de conformitate obținute în faza de determinare), decizia (acordarea, menținerea, revocarea, restrângerea, suspendarea, retragerea certificatului), atestarea, licențierea (emiterea certificatului), acordarea dreptului de utilizare a certificatului și a mărcii de conformitate).  
Supraveghere anuală prin efectuarea sau evaluarea esanționnelor din fabrică și/sau de pe piață; evaluarea producției, a livrării de servicii sau a funcționării procesului"  
"Selection (planning and preparation, specification of requirements), determining the characteristics (tests, project verification, evaluation of services or processes, verification and analysis (examination of the evidence of conformity obtained in the determination phase), decisions (granting, maintaining, extending, restricting, suspending or withdrawing the certification), certification, licensing (issuing the certificate, granting the right to use the certificate and the conformity mark).  
Annual surveillance by testing or evaluating samples from the factory and/or on the market; assessment of the production, service delivery or process operation"

Referințe/ References: Raport de audit/ Audit report nr.: 2014/17.07.2023

Data recertificării/ Renewing certification date	Data expirării/ Expiry date	Data certificării inițiale/ Initial certification date
19.07.2023	04.06.2026	21.03.2005

Valabilitatea certificatului este condiționată de efectuarea auditurilor de supraveghere anuale, confirmată prin rapoartele de audit și de reevaluarea completă ori cu recertificarea acestuia înainte de expirarea perioadei de valabilitate (3 ani).  
Certificate validity is conditioned by the annual surveillance audits, confirmed by audit reports and by product recertification with its complete reassessment before the expiry of validity period (3 years).  
Certificatul poate fi retras sau suspendat dacă nu se respectă cerințele de certificare a conformității producător.  
The Certificate may be withdrawn or suspended, if it is not adhered to requirements for conformity certification.  
Certificatul rămâne valabil dacă nu sunt modificate semnificativ documentele de referință, metodele de evaluare a condițiilor de fabricație și caracteristicile esențiale declarate.  
This certificate remains valid if the reference documents, methods for assessing the manufacturing conditions and the essential characteristics declared are not significantly changed.

DIRECTOR GENERAL  
GENERAL MANAGER  
ing. **Constantin AVRAM**

AEROQ S.A. - Strada Feleacu, nr. 14 B, Sector 1, București, România

F-141-96/Ed.10

**AEROQ**  
Organism pentru Certificarea Conformității Producător  
SR EN ISO/CEI 17065:2013  
Body for Product Conformity Certification  
SR EN ISO/CEI 17065:2013

**CERTIFICAT DE CONFORMITATE**  
CERTIFICATE OF CONFORMITY  
nr.: 620

Produsul: This is to certify that  
**PLĂCI CERAMICE PRESATE USCAT Gresie Porțelanată cu absorbție de apă E≤0.5%, grupa B la domeniul de utilizare: finisarea pardoselilor interioare și/sau exterioare**

fabricat de/ manufactured by: **SANEX S.A.**  
cu sediul în/ located at: **Cluj-Napoca, Strada Beiușului, nr. 1, Județul Cluj**

în fabrica / in factory: **SANEX S.A.**  
cu sediul în/ located at: **Cluj-Napoca, Strada Beiușului, nr. 1, Județul Cluj**

îndeplinește cerințele din: **SR EN 14411: 2012**

Schema de certificare a produsului / Product certification scheme:  
2 (similar schema 4 din SR EN ISO/CEI 17067) / like scheme 4 of SR EN ISO/CEI 17067  
"Seleția (planificarea și pregătirea, specificarea cerințelor), determinarea caracteristicilor (mecurii, verificarea proiectului, evaluarea serviciilor sau a proceselor, verificarea analizei (examinarea dovezilor de conformitate obținute în faza de determinare), decizia (acordarea, menținerea, revocarea, restrângerea, suspendarea, retragerea certificatului), atestarea, licențierea (emiterea certificatului), acordarea dreptului de utilizare a certificatului și a mărcii de conformitate).  
Supraveghere anuală prin efectuarea sau evaluarea esanționnelor din fabrică și/sau de pe piață; evaluarea producției, a livrării de servicii sau a funcționării procesului"  
"Selection (planning and preparation, specification of requirements), determining the characteristics (tests, project verification, evaluation of services or processes, verification and analysis (examination of the evidence of conformity obtained in the determination phase), decisions (granting, maintaining, extending, restricting, suspending or withdrawing the certification), certification, licensing (issuing the certificate, granting the right to use the certificate and the conformity mark).  
Annual surveillance by testing or evaluating samples from the factory and/or on the market; assessment of the production, service delivery or process operation"

Referințe/ References: Raport de audit/ Audit report nr.: 2316/12.08.2022

Data recertificării/ Renewing certification date	Data expirării/ Expiry date	Data certificării inițiale/ Initial certification date
16.08.2022	01.08.2025	29.07.2013

Valabilitatea certificatului este condiționată de efectuarea auditurilor de supraveghere anuale, confirmată prin rapoartele de audit și de reevaluarea completă ori cu recertificarea acestuia înainte de expirarea perioadei de valabilitate (3 ani).  
Certificate validity is conditioned by the annual surveillance audits, confirmed by audit reports and by product recertification with its complete reassessment before the expiry of validity period (3 years).  
Certificatul poate fi retras sau suspendat dacă nu se respectă cerințele de certificare a conformității producător.  
The Certificate may be withdrawn or suspended, if it is not adhered to requirements for conformity certification.  
Certificatul rămâne valabil dacă nu sunt modificate semnificativ documentele de referință, metodele de evaluare a condițiilor de fabricație și caracteristicile esențiale declarate.  
This certificate remains valid if the reference documents, methods for assessing the manufacturing conditions and the essential characteristics declared are not significantly changed.

DIRECTOR GENERAL  
GENERAL MANAGER  
ing. **Constantin AVRAM**

AEROQ S.A. - Strada Feleacu, nr. 14 B, Sector 1, București, România

F-141-96/Ed.10

MINISTERUL DEZVOLTĂRII, LUCRĂRIILOR PUBLICE ȘI ADMINISTRAȚIEI  
CONSILIUL TEHNIC PERMANENT PENTRU CONSTRUCȚII

**Agrement Tehnic**  
003-04/485-2022

**MOZAIAC CERAMIC PENTRU PLĂCAREA PEREȚILOR INTERIORE**  
CERAMIC MOSAIC FOR FINISHING INTERIOR WALLS  
KERAMIC FLİZLER İÇİN İNTERNEL DUVARLAR

PRODUCȚOR: **SANEX S.A. CLUJ-NAPOCA**  
Ștr. Beiușului, nr. 1,  
Cluj-Napoca,  
Județul Cluj  
Tel: 025946800  
Fax: 025946820

TITULAR AGREMENT TEHNIC: **SANEX S.A. CLUJ-NAPOCA**  
Ștr. Beiușului, nr. 1,  
Cluj-Napoca,  
Județul Cluj  
Tel: 025946800  
Fax: 025946820

ELABORATOR AGREMENT TEHNIC: **S.C. PROCEMA CERAMICARE S.R.L.**  
Ștr. Ponișilor nr. 40,  
Ștr. Ștefan cel Mare nr. 1,  
Cluj-Napoca,  
Județul Cluj  
Tel: 025946800  
Fax: 025946820

Grupă specializată nr. 4 - Franșe, proiecte autorizate și speciale, amenajări, planșe și pardoseli

Permisul agrement tehnic este valabil până la data de 29.03.2025, amasa de la data de ATTEZ. TEHNIC al Consiliului Tehnic Permanent pentru Construcții și nu este înlocuit de certificatul de calitate

MINISTERUL DEZVOLTĂRII, LUCRĂRIILOR PUBLICE ȘI ADMINISTRAȚIEI  
CONSILIUL TEHNIC PERMANENT PENTRU CONSTRUCȚII

**Agrement Tehnic**  
003-04/484-2021

**MOZAIAC CERAMIC PENTRU PLĂCAREA PARDOSELILOR ȘI PEREȚILOR INTERIORE ȘI/SU SAU EXTERIORE**  
CERAMIC MOSAIC FOR FINISHING INTERIOR AND/OR EXTERIOR WALLS AND/OR EXTERIOR FLOORS  
KERAMİK FLİZLER İÇİN İNTERNEL DUVARLAR VE DUVARLARIN DIŞI VE DUVARLARIN DIŞI YERLERİNİN DUVARLARININ VE DUVARLARININ DUVARLARININ

PRODUCȚOR: **SANEX S.A. CLUJ-NAPOCA**  
Ștr. Beiușului, nr. 1,  
Cluj-Napoca,  
Județul Cluj  
Tel: 025946800  
Fax: 025946820









TITULAR AGREMENT TEHNIC: **SANEX S.A. CLUJ-NAPOCA**  
Ștr. Beiușului, nr. 1,  
Cluj-Napoca,  
Județul Cluj  
Tel: 025946800  
Fax: 025946820

ELABORATOR AGREMENT TEHNIC: **S.C. PROCEMA CERAMICARE S.R.L.**  
Ștr. Ponișilor nr. 40,  
Ștr. Ștefan cel Mare nr. 1,  
Cluj-Napoca,  
Județul Cluj  
Tel: 025946800  
Fax: 025946820





Grupă specializată nr. 4 - Franșe, proiecte autorizate și speciale, amenajări, planșe și pardoseli

Permisul agrement tehnic este valabil până la data de 04.12.2024, amasa de la data de ATTEZ. TEHNIC al Consiliului Tehnic Permanent pentru Construcții și nu este înlocuit de certificatul de calitate

















	colecții noi / new collections
	protecție antibacteriană pe viață. / lifetime antibacterial protection.
	suprafață fină / soft touch
	suprafață mată care nu reflectă lumina / matt no reflex
	plăci ceramice pentru pereți / ceramic wall tiles
	plăci ceramice pentru pardoseli / ceramic floor tiles
	gresie porțelanată glazurată EN 14411Bla, E (absorbție de apă) < 0,5%, rezistentă la îngheț / glazed porcelain floor tile, EN 14411 Bla, E < 0,5%, frost resistant
	Super lucios / Super glossy
	decorare digitală CESAROM® / CESAROM® digital printing
	decorare digitală RAKO® / digital printing
	rectificat / rectified
	mozaic / mosaic
	suprafață netedă cu rezistență la alunecare / smooth slip-resistant surface
	grosime / thickness
	grosime / thickness
	grosime / thickness
	rezistență la alunecare / slip resistance
	simbol structură / structure symbol
	placă cu rezistență chimică ridicată / tile with increased chemical resistance

Variații intenționate sau posibile ale culorii, ale design-ului suprafețelor sau diversitate de culori și structuri. / Intentional or possible color variations and/or design of the surface or diversity of colors and structures.

	V1 fără variații / without variations
	V2 variații moderate / moderate variations
	V3 variații semnificative / significant variations
	V4 variații mari / great variations

Destinația plăcilor în funcție de grupa de rezistență la abraziune (PEI). / Destination of tiles according to surface abrasion resistance (PEI).

	Pardoseli pentru suprafețele de interior pe care se merge cu încălțăminte ușoară sau normală, expuse ocazional unui volum redus de particule abrazive (de exemplu, camerele de zi ale caselor, cu excepția bucătăriilor, intrărilor și altor camere care pot avea un trafic mai intens). Aceste recomandări nu se aplică la încălțăminte neobișnuită (adică bocanci cu ținte). / Floor coverings in areas that are walked on by soft soled or normal footwear with, at the most, occasional small amounts of scratching dirt (e.g. rooms in the living areas of homes but with the exception of kitchens, entrances, and other rooms which may have a lot of traffic). This does not apply to unusual footwear (i.e. hobnailed boots).
	Pardoseli pentru suprafețele pe care se merge cu încălțăminte normală, foarte adesea expuse unui volum redus de particule abrazive (de exemplu, bucătării de locuințe, holuri, coridoare, balcoane, logii și terase). Aceste prevederi nu se aplică la încălțăminte neobișnuită (adică bocanci cu ținte). / Floor coverings in areas that, with normal footwear, are walked on more often with small amounts of scratching dirt (e.g. residential kitchens, halls, corridors, balconies, loggias and terraces). This does not
	Pardoseli cu circulație normală expuse unui volum de particule abrazive, astfel încât condițiile sunt mai severe decât la clasa 3 (de exemplu, intrări, bucătării comerciale, hotel, săli de expoziții). / Floor coverings that are walked on by regular traffic with some scratching dirt so that the conditions are more severe than PEI 3 (e.g. entrances,
	Pardoseli care sunt supuse la circulație pietonală intensă cu un ritm susținut, cu particule abrazive, corespunzând condițiilor cele mai severe pentru care pot fi indicate plăcile glazurate (de exemplu, zone publice cum ar fi magazine, săli de așteptare în aeroporturi, foaierele hotelurilor, alei publice și utilizări industriale). / Floor coverings that are subject to severe pedestrian traffic over sustained periods with some scratching dirt, so that the conditions are the most severe for which glazed floor tiles may be suitable (e.g. public areas such as shopping centers, airport concourses, hotel foyers, public walkways and industrial applications).

	dimensiuni placă / tile dimensions
	standard / standard
	buc/cutie / pcs/box
	m <sup>2</sup> /cutie / m <sup>2</sup> /box
	cutii/palet / boxes/pallet
	m <sup>2</sup> /palet / m <sup>2</sup> /pallet
	kg/cutie / kg/box
	kg/palet / kg/pallet
	stoc limitat / limited stock
	neglazurat / unglazed

# lasselsbergergroup

**SANEX S.A.**

Str. Beiuşului nr. 1, 400394, Cluj-Napoca, România

Tel.: +40372 640 800; Fax: +40264 415 210

E-mail: [office@ro.lasselsberger.com](mailto:office@ro.lasselsberger.com)

**[www.cesarom.ro](http://www.cesarom.ro)**

